



WE LOVE PERFECTION.

# TOEBEHOREN ELEKTRISCH GEREEDSCHAP

ALGEMENE CATALOGUS



## De nieuwe kwb-catalogus met toebehoren voor elektrisch gereedschap

Beste klant,  
Hartelijk welkom in de nieuwe kwb-catalogus met toebehoren voor elektrisch gereedschap.

Al meer dan 80 jaar is kwb tools GmbH de systeemaanbieder voor handgereedschap en toebehoren voor elektrisch gereedschap.  
Veel ervaring, een hoge leveringscapaciteit, betrouwbare kwaliteit en innovatief denken en handelen zijn typische eigenschappen van een goed en sterk merk! En dat is kwb tools GmbH. Ons doel is om in de hele wereld kwb-artikelen van het hoogste kwaliteitsniveau in te kopen. Dit bewijst kwb tools GmbH elke dag opnieuw – met volle overgave voor u, onze partner.

Wij hebben in deze nieuwe kwb-catalogus de lay-out gemoderniseerd en daarbij veel informatie royaler en overzichtelijker vormgegeven.  
Laat u inspireren door deze nieuwe kwb-catalogus met toebehoren voor elektrisch gereedschap en ontdek de uitgebreidheid van het actuele kwb-assortiment aan toebehoren. In deze nieuwe kwb-catalogus vindt u vele noviteiten, die ons toebehorenprogramma voor elektrisch gereedschap nog completer maken.

Onder onze slogan ‘... altijd het passende toebehoren voor uw machine!’ biedt kwb zijn klanten en dus ook de consumenten al het toebehoren dat ze voor hun machines nodig hebben.



Gerrit Brand en Alexander Uhl, directeurs van kwb tools

Product	Artikel	Pagina
<b>Boren</b>	KOBALT HSS-CO-spiraalboren	10 - 13
	TITAAN HSS-spiraalboren	14 - 15
	SILVER STAR HSS- spiraalboren	16 - 21
	HSS-spiraalboren	22 - 27
	Spiraalborenslijper	27
	Hamerboren SDS-max, SDS-plus	32, 35 - 38
	Beitels voor boorhamers SDS-max, SDS-plus	32 - 34, 39 - 40
	CROSS TIP hamerboren	41
	Betonboren Bosch UNEO	42
	Beton- en steenboren ROCKER® / SUPER ROCKER®	42 - 45
	Steenboren, muurdoorvoerboren	45 - 48
	EASY CUT universele hamerboren SDS-plus, EASY CUT universele boren	52 - 53
	Gresboren, glasboren, div. HM-gereedschappen	54 - 56
	Hardhoutboren	60
	Houtspiraalboren, balkenboren, bekistingsboren, slangenboren	61 - 66
	Scharniergatboren, forstnerboren, vlakfreesboren, centerboren	67 - 69
<b>Bits</b>	Bithouders, Impaktor bits, bits, Handy bitboxen, schroefgereedschapsets	74 - 98
<b>Boormachinetoeberehen</b>	Boorhouders	102 - 103
	Boorhoudersleutels	104
	Raspen, verzinkers, plaatboren, freesboren	105 - 113
	Hulpstukken, boorstandaarden, buigzame assen	114
	Slijpstiften	115 - 117
	Pompen	118 - 119
	Verfmengers	120 - 121
<b>Gatenzagen</b>	Boorkronen, gatenzagen	128 - 140
<b>Borstels</b>	Draadborstels, nylon borstels	144 - 150
<b>Slijpen</b>	Schuurrollen, schuurpapiervellen	156 - 159
	Standaard schuurpaperschijven, QUICK-STICK schuurpaperschijven	162 - 167
	Standaard steunschijven, QUICK-STICK steunschijven	162, 163 + 167
	QUICK-STICK schuurpapierdriehoeken, schuurvlies	170 - 174
	QUICK-STICK steunschijven	174
	Standaard schuurpapierstroken, QUICK-STICK schuurpapierstroken	180 - 182, 182 - 184
	Schuurgaas	185
	Schuurbanden	189 - 192
	Schuurpads, staalwol	193 - 194, 195
	Handschuurblokken	196 - 197
	Vliesmopstift, lamellenslijpers	198
Polijstvachten, polijstschijven	199 - 201	
<b>Bovenfrezen</b>	Bovenfrezen	206 - 210
<b>Hardmetalen schaafmessen</b>	Hardmetalen schaafmessen	211
<b>Line Master</b>	LINE MASTER, Meet- en geleidingssysteem	213 - 220
<b>Decoupeerzaagbladen</b>	Decoupeerzaagbladen	224 - 232
<b>Reciprozaagbladen</b>	Reciprozaagbladen	233 - 238
	MULTITOOL-toebehoren	239 - 245
<b>Cirkelzaagbladen</b>	Cirkelzaagbladen	247 - 278
<b>Zaagkettingen</b>	Zaagkettingen	279 - 306
<b>Nylon draad</b>	Nylon draad	309
<b>Tackers</b>	Elektrische tackers TACKERTRONIX®, hamertackers	314
<b>Lijmpistolen</b>	Handtackers, bevestigingsmiddelen	315 - 325
	Hetelijmpistolen	326 - 327
<b>Bevestigen</b>	Deuvels, deuvelhulpmiddelen, deuvel-boormallen	332 - 335
<b>Doorslijpschijven</b>	Doorslijp- en schuurschijven, schuurmoppen	340 - 342
<b>Draadborstels</b>	Reinigingsschijven, fiberschijven, steunschijven voor haakse slijpers	342 - 344
	Diamantdoorslijpschijven, schuurschijven, keramische schuurschijven	345 - 347
	Draadborstels	348 - 349
	Pensleutels, haakseslijperstandaarden	350 - 351

## Toelichting bij de catalogus

1

2

### Penseelborstel, HSS-staaldraad



3



Penseelborstel, HSS-staaldraad, golvend, om te ontroesten, te reinigen, coatings, verf en overtollig rubber te verwijderen, te decaperen, te ontbramen, op te ruwen en mat te maken, voor metaal en steen, ideaal voor werkzaamheden op moeilijk toegankelijke plekken en binnenvlakken, bijv. smeedijzeren poorten, roosters, sierhekken enz.

4

5

6

7

8

Art.-Nr.	Ø mm	T mm	Draht Ø mm				EAN
<b>SB-Karte</b> 9							
608030	25	6	0,30	grob		6	4 009316 080306

lose Depotkarton							
608033	25	6	0,30	grob		Z24	4 009316 080337

### 1 Artikelnaam

### 2 Kwaliteitsniveau

Zie verklaring op pagina 5

### 3 Afbeelding

Verpakking / product / toepassing

### 4 Uitvoerige productbeschrijving

### 5 kwb-artikelnummer

is tegelijkertijd het ordernummer van het product

### 6 Technische productgegevens en gebruiksinstructies

### 7 Symbool = artikelen verpakt voor ZB

op kaarten, in zakken of in dozen met en zonder ophanghulp

**Symbool in bovenstaand voorbeeld:**

Symbool vermeld bijv. bij 608030 = ZB-verpakking

Symbool niet vermeld bijv. bij 608033 = los artikel

### 8 Symbool = VE, verpakkingseenheid

### 9 Verpakkingsinformatie

## kwb-kwaliteitsniveaus

### kwb staat voor kwaliteit.

Met het kwaliteitssysteem van kwb, dat uit drie niveaus bestaat, vindt u altijd het juiste gereedschap voor uw toepassings en gebruiksfrequentie.



### **PROFESSIONAL**



De beste kwb-kwaliteit, ook geschikt voor continu gebruik in professionele toepassingen. 5 jaar garantie.



### **HIGH QUALITY**



De hoogwaardige kwb-kwaliteit, geschikt voor alle professionals en doe-het-zelvers.



### **QUALITY**



De goede gebruikskwaliteit van kwb, voor de doe-het-zelver.

**... altijd de passende toebehoren voor uw machine!**





# METAALBOREN

**KOBALT HSS-CO-boren**

**TITAAN HSS-boren**

**SILVER STAR HSS-boren**

**HSS-spiraalboren**

## Metaalboren



### De voordelen van geslepen boren KOBALT HSS CO, TITAAN HSS en SILVER STAR HSS

- Lange levensduur dankzij precies geslepen spiralen
- Exact boorgat met weinig tolerantie
- Kruisgeslepen boren vergemakkelijken het centreren zonder centerpons of voorboring
- Hoogwaardige oppervlakteafwerking en daardoor een langere levensduur bij een hogere belasting

## Programma overzicht HSS-metaalspiraalboren



### KOBALT HSS-CO-spiraalboren, DIN 338 ★★★★★

Door de samenstelling van het staal met 5% kobalt heeft de boor een hoge hittebestendigheid met beperkte slijtage in de hardste materialen, zoals bijv. rvs.

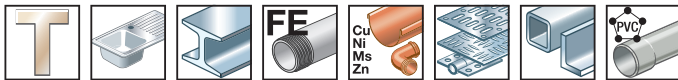

Pagina 10 - 13



### TITAAN HSS-spiraalboren, DIN 338 ★★★★★

Hoogwaardige oppervlakteafwerking en daardoor een langere levensduur bij maximale prestaties.



Pagina 14 - 15



### SILVER STAR HSS-spiraalboren, DIN 338 ★★★★★

Tot 40% sneller en 50% minder aandrukkracht.

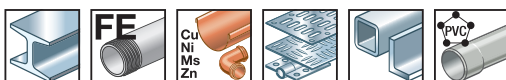

Pagina 16 - 21



### HSS-spiraalboren, extra lang, DIN 340 ★★★★★

Tot 40% sneller en 50% minder aandrukkracht. De extra lange spiraalboren zijn bijzonder goed geschikt voor gebruik in gleuven, groeven, verdiepingen, holle voorwerpen, profielen enz.



Pagina 23





### kwb-info

#### Het kleurcodesysteem van de metaalborenverpakkingen

Met de borenverpakkingen wil kwb doelgerichte consumenteninformatie bieden. Ze vallen op door hun duidelijke kleurcode-systeem dat het te bewerken materiaal aangeeft, en hun ondubbelzinnige toepassingsfoto's.

- KOBALT
- TITAAN
- SILVER STAR
- HSS-spiraalboren



#### HSS-spiraalboren, rolgewalst, DIN 338 ★★★

Rolgewalst, een voordelige HSS-boor voor alle boringen in staal, gietijzer, non-ferrometaal en kunststof



Pagina 23 - 26



#### HSS-spiraalboor, afgedraaide schacht, DIN 338 ★★★

Dankzij de afgedraaide schacht kunnen grote diameters worden gebruikt in normale boormachines. Geschikt voor boorhouders met een klembreedte van 10 en 13 mm.



Pagina 27

### Aanbevolen toerental voor HSS-boren

R.p.M. max.	Titaan	Rvs	Staal	IJzer	Non-ferrometaal	Plaatstaal	Profielen	Kunststof
≤ Ø 2 mm	1590	1590	3980	4780	7170	3980	12740	3980
Ø 2,1 - 4 mm	800	800	1990	2390	3580	1990	6370	1990
Ø 4,1 - 6 mm	530	530	1330	1590	2390	1330	4250	1330
Ø 6,1 - 8 mm	400	400	1000	1190	1790	1000	3180	1000
Ø 8,1 - 10 mm	320	320	800	960	1430	800	2550	800
Ø 10,1 - 12 mm	270	270	660	800	1190	660	2120	660
Ø 12,1 - 13 mm	230	230	570	680	1020	570	1820	570

**KOBALT HSS-CO-spiraalboren, DIN 338, ZB-kaart**



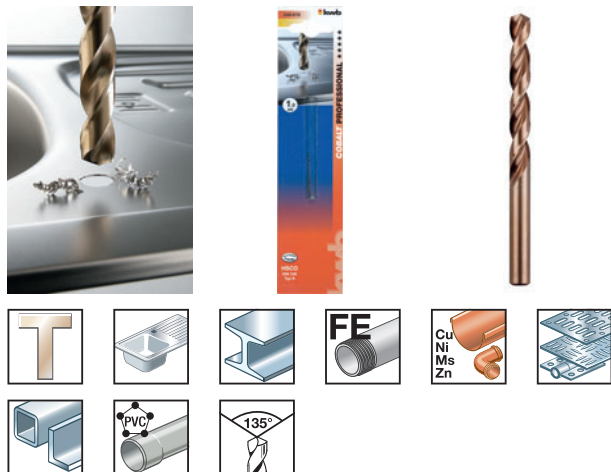

Rechts snijdend, type N, kobaltlegering 5%, precisiegeslepen, kleur brons, punthoek 135°, met kruisgeslepen punt volgens DIN 1412C, zelf-centrerend, cilindrisch, industriële kwaliteit, extreme warmtebestendigheid voor moeilijk verspaanbare materialen zoals bijv. gelegeerd en on-gelegeerd staal, rvs V2A/V4A, machinegietijzer en gietstaal, brons en kunststof.



Art.-nr.	Ø mm	Kergat voor schroefdraadmaat			EAN
<b>ZB-kaart</b>					
248610	1			10	4 0093 12 486 102
248615	1,5			10	4 0093 12 486 157
248620	2			10	4 0093 12 486 201
248625	2,5	M 3		10	4 0093 12 486 256
248630	3			10	4 0093 12 486 300
248633	3,3	M 4		10	4 0093 12 486 331
248635	3,5			10	4 0093 12 486 355
248640	4			5	4 0093 12 486 409
248642	4,2	M 5		5	4 0093 12 486 423
248645	4,5			5	4 0093 12 486 454
248650	5	M 6		5	4 0093 12 486 508
248655	5,5			5	4 0093 12 486 553
248660	6	M 7		5	4 0093 12 486 607
248665	6,5			5	4 0093 12 486 652
248668	6,8	M 8		5	4 0093 12 486 683
248670	7			3	4 0093 12 486 706
248675	7,5			3	4 0093 12 486 751
248680	8			3	4 0093 12 486 805
248685	8,5	M 10		3	4 0093 12 486 850
248690	9			3	4 0093 12 486 904
248695	9,5	M 11		3	4 0093 12 486 959
248700	10			3	4 0093 12 487 000
248710	11			2	4 0093 12 487 109
248720	12			2	4 0093 12 487 208
248730	13			2	4 0093 12 487 307

## KOBALT HSS-CO-spiraalboren, DIN 338, los



Art.-nr.	Ø mm	Kerngat voor schroefdraadmaat			EAN
<b>Los, zak</b>					
248010	1			Z10	4 009312 480100
248015	1,5			Z10	4 009312 480155
248020	2			Z10	4 009312 480209
248025	2,5	M 3		Z10	4 009312 480254
248030	3			Z10	4 009312 480308
248033	3,3	M 4		Z10	4 009312 480339
248035	3,5			Z10	4 009312 480353
248040	4			Z5	4 009312 480407
248042	4,2	M 5		Z5	4 009312 480421
248045	4,5			Z5	4 009312 480452
248050	5	M 6		Z5	4 009312 480506
248055	5,5			Z5	4 009312 480551
248060	6	M 7		Z5	4 009312 480605
248065	6,5			Z5	4 009312 480650
248068	6,8	M 8		Z5	4 009312 480681
248070	7			Z3	4 009312 480704
248075	7,5			Z3	4 009312 480759
248080	8			Z3	4 009312 480803
248085	8,5	M 10		Z3	4 009312 480858
248090	9			Z3	4 009312 480902
248095	9,5	M 11		Z3	4 009312 480956
248100	10			Z3	4 009312 481008
248102	10,2	M 12		Z3	4 009312 481022
248105	10,5			Z3	4 009312 481053
248110	11			Z2	4 009312 481107
248115	11,5			Z2	4 009312 481152
248120	12	M 14		Z2	4 009312 481206
248125	12,5			Z2	4 009312 481251
248130	13			Z2	4 009312 481305

Rechts snijdend, type N, kobaltlegering 5%, precisiegeslepen, kleur brons, punthoek 135°, met kruisgeslepen punt volgens DIN 1412C, zelfcentrerend, cilindrisch, industriële kwaliteit, extreme warmtebestendigheid voor moeilijk verspanbare materialen zoals bijv. gelegeerd en ongelegeerd staal, rvs V2A/V4A, machinegietijzer en gietstaal, brons en kunststof.



... altijd de passende toebehoren voor uw machine!

**KOBALT HSS-CO-spiraalborensset, DIN 338, 19-delig**



Rechts snijdend, type N, kobaltlegering 5%, precisiegeslepen, kleur brons, punthoek 135°, met kruisgeslepen punt volgens DIN 1412C, zelf-centrerend, cilindrisch, industriële kwaliteit, extreme warmtebestendigheid voor moeilijk verspaanbare materialen zoals bijv. gelegeerd en ongelegeerd staal, rvs V2A/V4A, machinegietijzer en gietstaal, brons en kunststof.

Art.-nr.	Ø mm	Toename			EAN
248920	1 - 10	0,5		1	4 009312 489202

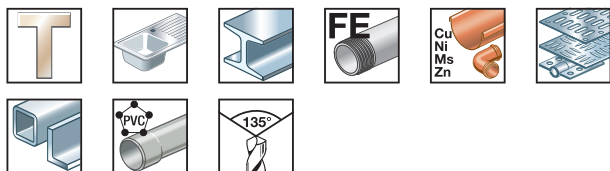

**KOBALT HSS-CO-spiraalborensset, DIN 338, 13-delig**



Rechts snijdend, type N, kobaltlegering 5%, precisiegeslepen, kleur brons, punthoek 135°, met kruisgeslepen punt volgens DIN 1412C, zelf-centrerend, cilindrisch, industriële kwaliteit, extreme warmtebestendigheid voor moeilijk verspaanbare materialen zoals bijv. gelegeerd en ongelegeerd staal, rvs V2A/V4A, machinegietijzer en gietstaal, brons en kunststof.

Art.-nr.	Ø mm	Toename			EAN
421600	1,5 - 6,5 plus 3,3 en 4,2	0,5		6	4 009314 216004

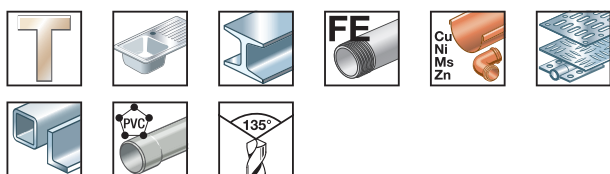

## KOBALT HSS-CO-spiraalborensset, DIN 338, 6-delig



Art.-nr.	Ø mm			EAN
428040	2, 3, 4, 5, 6, 8		6	4 009314 280401

Rechts snijdend, type N, kobaltlegering 5%, precisiegeslepen, kleur brons, punthoek 135°, met kruisgeslepen punt volgens DIN 1412C, zelfcentrerend, cilindrisch, industriële kwaliteit, extreme warmtebestendigheid voor moeilijk verspanbare materialen zoals bijv. gelegeerd en ongelegeerd staal, rvs V2A/V4A, machinegietijzer en gietstaal, brons en kunststof.

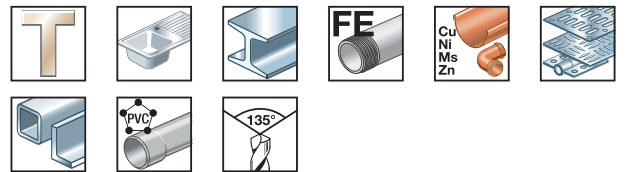

### kwb-Info

## Een kwestie van veiligheid



Ons oog is een van onze belangrijkste zintuigen en moet dus bij alle werkzaamheden worden beschermd.

Daarom heeft kwb voor alle gangbare binnen- en buitentoepassingen, zoals boren, frezen, slijpen en lassen, een hoogwaardig, ook voor bril dragers geschikt assortiment veiligheidsbrillen samengesteld.

Alle informatie hierover vindt u in onze kwb-folder voor arbeidsveiligheid of op het internet op [www.kwb.eu](http://www.kwb.eu)



**TITAN HSS-spiraalboren, DIN 338, ZB-kaart**



rechts snijdend, type N, titaan genitreerd, precisiegeslepen, kleur goud, punthoek 135°, met kruisgeslepen punt volgens DIN 1412 C, zelfcenterend, cilindrisch, industriële kwaliteit, hoogwaardige oppervlakteafwerking voor een beperkte wrijving en een lange levensduur bij maximale continue belasting in materialen zoals bijv. gelegeerd en ongelegeerd staal, gietstaal, smeedbaar gietijzer, sinterijzer, nieuwzilver, koper, brons en harde kunststof.

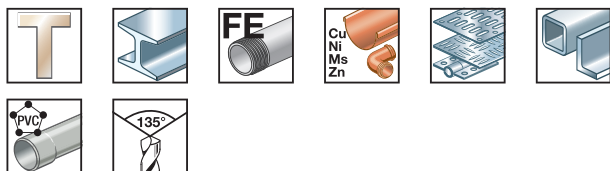

Art.-nr.	Ø mm	Inhoud per pak	Kerngat voor schroefdraadmaat			EAN
<b>ZB-kaart</b>						
238610	1	1			5	4 0093 12 386405
238615	1,5	1			5	4 0093 12 386450
238620	2	1			5	4 0093 12 386204
238625	2,5	1	M 3		5	4 0093 12 386259
238630	3	1			5	4 0093 12 386303
238633	3,3	1	M 4		5	4 0093 12 386334
238635	3,5	1			5	4 0093 12 386358
238640	4	1			3	4 0093 12 386402
238642	4,2	1	M 5		3	4 0093 12 386426
238645	4,5	1			3	4 0093 12 386457
238650	5	1	M 6		3	4 0093 12 386501
238655	5,5	1			3	4 0093 12 386556
238660	6	1	M 7		3	4 0093 12 386600
238665	6,5	1			3	4 0093 12 386655
238670	7	1			2	4 0093 12 386709
238680	8	1			2	4 0093 12 386808
238690	9	1			2	4 0093 12 386907
238700	10	1			2	4 0093 12 387003
238720	12	1	M 14		1	4 0093 12 387201
238730	13	1			1	4 0093 12 387300

**TITAN HSS-spiraalborensset, DIN 338, 19-delig**





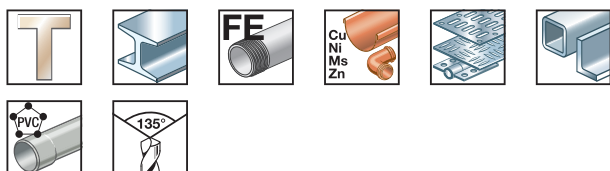

rechts snijdend, type N, titaan genitreerd, precisiegeslepen, kleur goud, punthoek 135°, met kruisgeslepen punt volgens DIN 1412 C, zelfcenterend, cilindrisch, industriële kwaliteit, hoogwaardige oppervlakteafwerking voor een beperkte wrijving en een lange levensduur bij maximale continue belasting in materialen zoals bijv. gelegeerd en ongelegeerd staal, gietstaal, smeedbaar gietijzer, sinterijzer, nieuwzilver, koper, brons en harde kunststof.



Art.-nr.	Ø mm	Toename			EAN
421820	1 - 10	0,5		1	4 0093 14 218206

## TITAAN HSS-spiraalborensset, DIN 338, 13-delig



Art.-nr.	Ø mm	Toename			EAN
427140	1,5 - 6,5 plus 3,3 en 4,2	0,5		1	

rechts snijdend, type N, titaan genitreerd, precisiegeslepen, kleur goud, punthoek 135°, met kruisgeslepen punt volgens DIN 1412 C, zelfcenterend, cilindrisch, industriële kwaliteit, hoogwaardige oppervlakteafwerking voor een beperkte wrijving en een lange levensduur bij maximale continue belasting in materialen zoals bijv. gelegeerd en ongelegeerd staal, gietstaal, smeedbaar gietijzer, sinterijzer, nieuwzilver, koper, brons en harde kunststof.

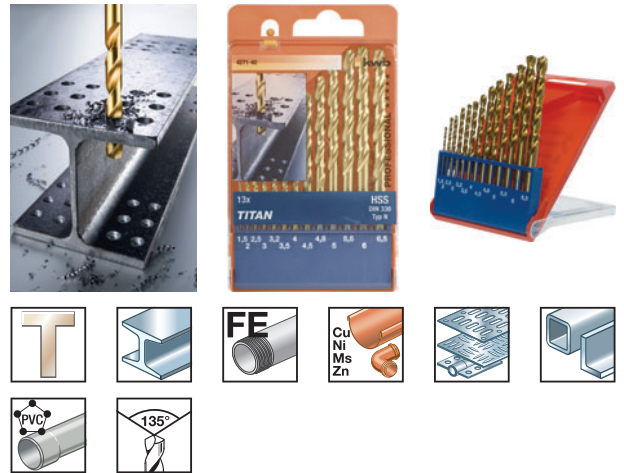

## TITAAN HSS-spiraalborensset, DIN 338, 6-delig



Art.-nr.	Ø mm			EAN
427040	2, 3, 4, 5, 6, 8		1	

rechts snijdend, type N, titaan genitreerd, precisiegeslepen, kleur goud, punthoek 135°, met kruisgeslepen punt volgens DIN 1412 C, zelfcenterend, cilindrisch, industriële kwaliteit, hoogwaardige oppervlakteafwerking voor een beperkte wrijving en een lange levensduur bij maximale continue belasting in materialen zoals bijv. gelegeerd en ongelegeerd staal, gietstaal, smeedbaar gietijzer, sinterijzer, nieuwzilver, koper, brons en harde kunststof.

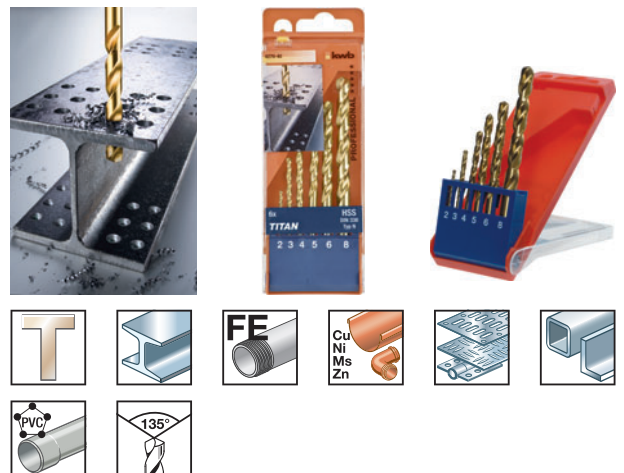

**SILVER STAR HSS-spiraalboren, DIN 338, ZB-kaart**



Rechts snijdend, type N, precisiegeslepen, kleur blank, punthoek 135°, met kruisgeslepen punt volgens DIN 1412 C, zelfcenterend, cilindrisch, industriële kwaliteit, voor bijv. gelegeerd en ongelegeerd staan, gietstaal, smeedbaar gietijzer, sinterijzer, non-ferrometaal, harde kunststof.

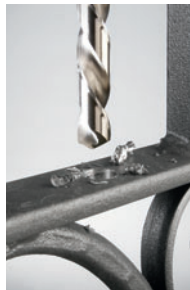





































Art.-nr.	Ø mm	Inhoud per pak	Kerngat voor schroefdraadmaat			EAN
<b>ZB-kaart</b>						
206510	1	2			10	4 0093 12 065 109
206515	1,5	2			10	4 0093 12 065 154
206520	2	2			10	4 0093 12 065 208
206525	2,5	2	M 3		10	4 0093 12 065 253
206530	3	2	M 3,5		10	4 0093 12 065 307
206532	3,2	1			10	4 0093 12 065 321
206533	3,3	1	M 4		10	4 0093 12 065 338
206535	3,5	1			10	4 0093 12 065 352
206540	4	1			10	4 0093 12 065 406
206542	4,2	1	M 5		10	4 0093 12 065 420
206545	4,5	1			10	4 0093 12 065 451
206548	4,8	1			10	4 0093 12 065 482
206550	5	1	M 6		10	4 0093 12 065 505
206555	5,5	1			10	4 0093 12 065 550
206560	6	1	M 7		10	4 0093 12 065 604
206565	6,5	1			10	4 0093 12 065 659
206568	6,8	1	M 8		10	4 0093 12 065 680
206570	7	1			10	4 0093 12 065 703
206575	7,5	1			10	4 0093 12 065 758
206580	8	1			10	4 0093 12 065 802
206585	8,5	1	M 10		10	4 0093 12 065 857
206590	9	1			10	4 0093 12 065 901
206595	9,5	1	M 11		10	4 0093 12 065 956
206600	10	1			10	4 0093 12 066 007
206602	10,2	1	M 12		5	4 0093 12 066 021
206610	11	1			5	4 0093 12 066 106
206620	12	1	M 14		5	4 0093 12 066 205
206630	13	1			5	4 0093 12 066 304



## SILVER STAR HSS-spiraalboren, DIN 338, los



Art.-nr.	Ø mm	Kerngat voor schroefdraadmaat			EAN
<b>Los, zak</b>					
205003	0,3			Z10	
205004	0,4			Z10	
205005	0,5			Z10	
205006	0,6			Z10	
205007	0,7			Z10	
205008	0,8			Z10	
205009	0,9			Z10	
205010	1			Z10	
205011	1,1	M 1,4		Z10	
205012	1,2			Z10	
205013	1,3			Z10	
205014	1,4			Z10	
205015	1,5			Z10	
205016	1,6	M 2		Z10	
205017	1,7			Z10	
205018	1,8			Z10	
205019	1,9			Z10	
205020	2			Z10	
205021	2,1			Z10	
205022	2,2			Z10	
205023	2,3			Z10	
205024	2,4			Z10	
205025	2,5	M 3		Z10	
205026	2,6			Z10	
205027	2,7			Z10	
205028	2,8			Z10	
205029	2,9			Z10	
205030	3	M 3,5		Z10	
205031	3,1			Z10	
205032	3,1			Z10	
205033	3,3	M 4		Z10	
205034	3,4			Z10	
205035	3,5			Z10	
205036	3,6			Z10	
205037	3,7	M 4,5		Z10	
205038	3,8			Z10	

Rechts snijdend, type N, precisiegeslepen, kleur blank, punthoek 135°, met kruisgeslepen punt volgens DIN 1412 C, zelfcenterend, cilindrisch, industriële kwaliteit, voor bijv. gelegeerd en ongelegeerd staan, gietstaal, smeedbaar gietijzer, sinterijzer, non-ferrometaal, harde kunststof.

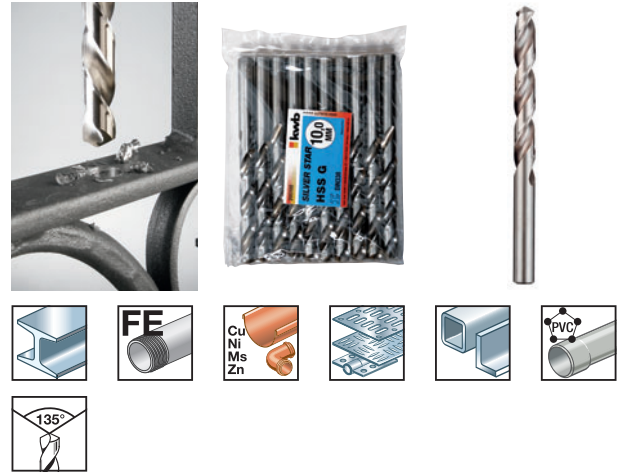

SILVER STAR HSS-spiraalboren, DIN 338, los



Art.-nr.	Ø mm	Kerfmaat voor schroefdraadmaat			EAN
205039	3,9			Z10	4 0093 12 050396
205040	4			Z10	4 0093 12 050402
205041	4,1			Z10	4 0093 12 050419
205042	4,2	M 5		Z10	4 0093 12 050426
205043	4,3			Z10	4 0093 12 050433
205044	4,4			Z10	4 0093 12 050440
205045	4,5			Z10	4 0093 12 050457
205046	4,6			Z10	4 0093 12 050464
205047	4,7			Z10	4 0093 12 050471
205048	4,8			Z10	4 0093 12 050488
205049	4,9			Z10	4 0093 12 050495
205050	5	M 6		Z10	4 0093 12 050501
205051	5,1			Z10	4 0093 12 050518
205052	5,2			Z10	4 0093 12 050525
205053	5,3			Z10	4 0093 12 050532
205054	5,4			Z10	4 0093 12 050549
205055	5,5			Z10	4 0093 12 050556
205056	5,6			Z10	4 0093 12 050563
205057	5,7			Z10	4 0093 12 050570
205058	5,8			Z10	4 0093 12 050587
205059	5,9			Z10	4 0093 12 050594
205060	6	M 7		Z10	4 0093 12 050600
205061	6,1			Z10	4 0093 12 050617
205062	6,2			Z10	4 0093 12 050624
205063	6,3			Z10	4 0093 12 050631
205064	6,4			Z10	4 0093 12 050648
205065	6,5			Z10	4 0093 12 050655
205066	6,6			Z10	4 0093 12 050662
205067	6,7			Z10	4 0093 12 050679
205068	6,8	M 8		Z10	4 0093 12 050686
205069	6,9			Z10	4 0093 12 050693
205070	7			Z10	4 0093 12 050709
205071	7,1			Z10	4 0093 12 050716
205072	7,2			Z10	4 0093 12 050723
205073	7,3			Z10	4 0093 12 050730
205074	7,4			Z10	4 0093 12 050747
205075	7,5			Z10	4 0093 12 050754

## SILVER STAR HSS-spiraalboren, DIN 338, los



Art.-nr.	Ø mm	Kerngat voor schroefdraadmaat			EAN
205076	7,6			Z10	4 009312 050761
205077	7,7			Z10	4 009312 050778
205078	7,8	M 9		Z10	4 009312 050785
205079	7,9			Z10	4 009312 050792
205080	8			Z10	4 009312 050808
205081	8,1			Z10	4 009312 050815
205082	8,2			Z10	4 009312 050822
205083	8,3			Z10	4 009312 050839
205084	8,4			Z10	4 009312 050846
205085	8,5	M 10 x 1,5		Z10	4 009312 050853
205086	8,6			Z10	4 009312 050860
205087	8,7			Z10	4 009312 050877
205088	8,8			Z10	4 009312 050884
205089	8,9			Z10	4 009312 050891
205090	9			Z10	4 009312 050907
205091	9,1			Z10	4 009312 050914
205092	9,2			Z10	4 009312 050921
205093	9,3			Z10	4 009312 050938
205094	9,4			Z10	4 009312 050945
205095	9,5	M 10 x 0,5		Z10	4 009312 050952
205096	9,6	M 11 x 1,5		Z10	4 009312 050969
205097	9,7			Z10	4 009312 050976
205098	9,8			Z10	4 009312 050983
205099	9,9			Z10	4 009312 050990
205100	10			Z10	4 009312 051003
205105	10,5	M 12 x 1,5		Z10	4 009312 051058
205110	11			Z5	4 009312 051102
205115	11,5			Z5	4 009312 051157
205120	12	M 14		Z5	4 009312 051201
205125	12,5			Z5	4 009312 051256
205130	13			Z5	4 009312 051300

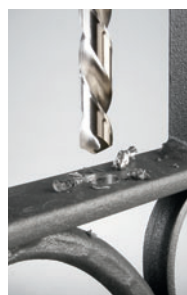

... altijd de passende toebehoren voor uw machine!

**SILVER STAR HSS-spiraalborenset, DIN 338, 25-delig**



Rechts snijdend, type N, precisiegeslepen, kleur blank, punthoek 135°, met kruisgeslepen punt volgens DIN 1412 C, zelfcenterend, cilindrisch, industriële kwaliteit, voor bijv. gelegeerd en ongelegeerd staan, gietstaal, smeedbaar gietijzer, sinterijzer, non-ferrometaal, harde kunststof.

Art.-nr.	Ø mm	Toename			EAN
205720	1 - 13	0,5		1	4 009312 05720

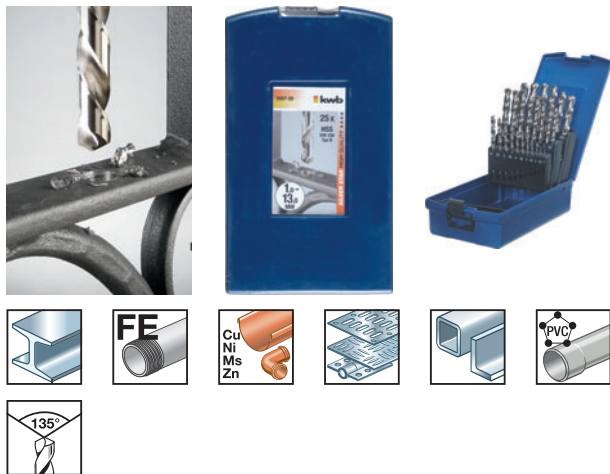

**SILVER STAR HSS-spiraalborenset, DIN 338, 19-delig**



Rechts snijdend, type N, precisiegeslepen, kleur blank, punthoek 135°, met kruisgeslepen punt volgens DIN 1412 C, zelfcenterend, cilindrisch, industriële kwaliteit, voor bijv. gelegeerd en ongelegeerd staan, gietstaal, smeedbaar gietijzer, sinterijzer, non-ferrometaal, harde kunststof.

Art.-nr.	Ø mm	Toename			EAN
205920	1 - 10	0,5		4	4 009312 059207

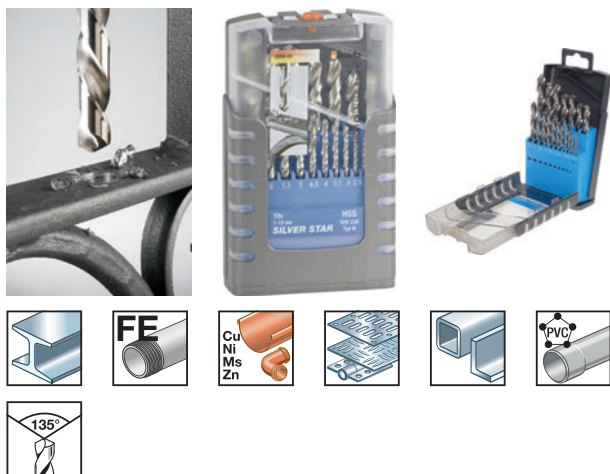

**kwb-Info**

**Verleng de levensduur van uw boren!**





Voor een langere levensduur en een duurzame kwaliteit van HSS-boren raden wij u de spiraalborenslijper van kwb aan. Gewoon op de boormachine bevestigen en u kunt spiraalboren met een diameter van 3,5 - 10 mm slijpen.

Dit product vindt u in de catalogus op pagina 27.



## SILVER STAR HSS-spiraalborenset, DIN 338, 13-delig





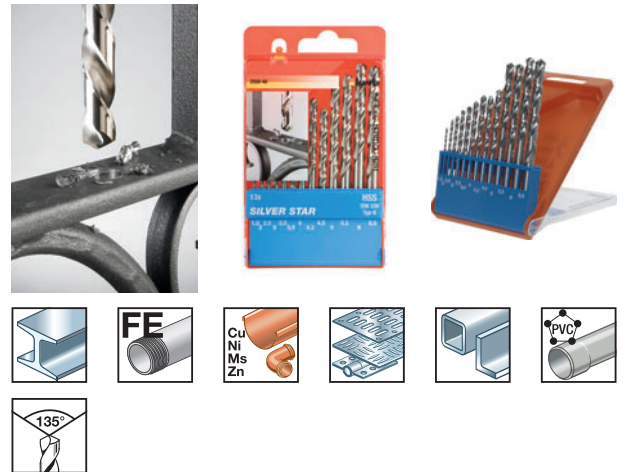

Art.-nr.	Ø mm	Toename			EAN
205840	1,5 - 6,5 plus 3,3 en 4,2	0,5		6	

Rechts snijdend, type N, precisiegeslepen, kleur blank, punthoek 135°, met kruisgeslepen punt volgens DIN 1412 C, zelfcenterend, cilindrisch, industriële kwaliteit, voor bijv. gelegeerd en ongelegeerd staan, gietstaal, smeedbaar gietijzer, sinterijzer, non-ferrometaal, harde kunststof.



## SILVER STAR HSS-spiraalborenset, DIN 338, 6-delig



Art.-nr.	Ø mm			EAN
205540	2, 3, 4, 5, 6, 8		6	

Rechts snijdend, type N, precisiegeslepen, kleur blank, punthoek 135°, met kruisgeslepen punt volgens DIN 1412 C, zelfcenterend, cilindrisch, industriële kwaliteit, voor bijv. gelegeerd en ongelegeerd staan, gietstaal, smeedbaar gietijzer, sinterijzer, non-ferrometaal, harde kunststof.

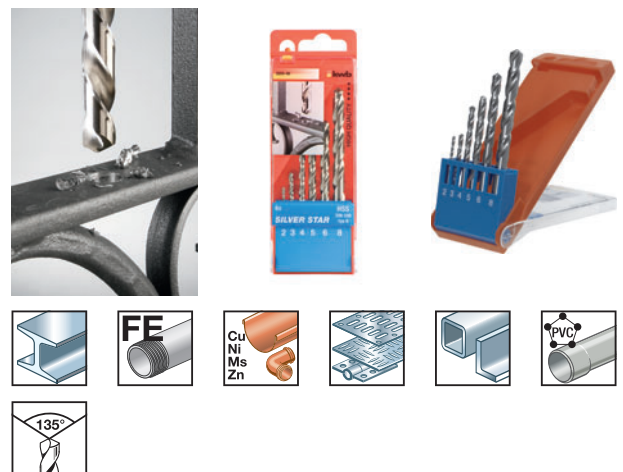







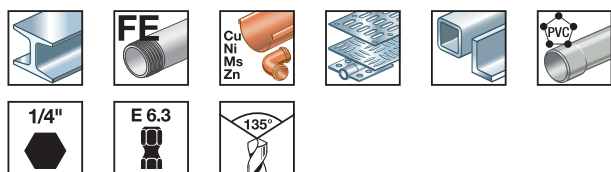







**HSS-spiraalboren met zeskanthouder 1/4", E 6.3**



HSS-spiraalboren met zeskanthouder 1/4", houder volgens ISO 1173, E 6.3, rechts snijdend, type N, precisiegeslepen, voor alle accuschroevendraaiers, boormachines en bithouders met 1/4"-houder volgens ISO 1173, kleur blank, punthoek 135°, voor gelegeerd en ongelegeerd staal, gietstaal, smeedbaar gietijzer, sinterijzer, non-ferrometalen en harde kunststoffen.







Art.-nr.			Ø mm			EAN
421102	15	21	2		10	
421103	15	21	3		10	
421104	20	28	4		10	
421105	25	34	5		10	
421106	27	34	6		10	

**HSS-spiraalborenset met zeskanthouder 1/4", E 6.3, 5-delig**

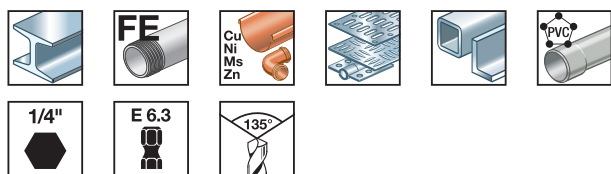



























HSS-spiraalboren met zeskanthouder 1/4", houder volgens ISO 1173, E 6.3, rechts snijdend, type N, precisiegeslepen, voor alle accuschroevendraaiers, boormachines en bithouders met 1/4"-houder volgens ISO 1173, kleur blank, punthoek 135°, voor gelegeerd en ongelegeerd staal, gietstaal, smeedbaar gietijzer, sinterijzer, non-ferrometalen en harde kunststoffen.



Art.-nr.	Ø mm			EAN
421140	2, 3, 4, 5, 6		6	

## HSS-spiraalboren, lange uitvoering, DIN 340, ZB-etui met kaart



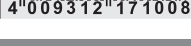



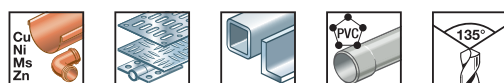



































Art.-nr.			Ø mm	Inhoud per pak			EAN
<b>ZB-etui met kaart</b>							
217030	65	100	3	1		10	
217035	75	112	3,5	1		10	
217040	78	119	4	1		10	
217045	80	126	4,5	1		10	
217050	85	132	5	1		10	
217055	90	139	5,5	1		10	
217060	90	139	6	1		10	
217065	95	149	6,5	1		10	
217070	100	156	7	1		10	
217080	110	165	8	1		10	
217090	115	175	9	1		10	
217100	120	194	10	1		10	

Rechts snijdend, type N, precisiegeslepen, kleur blank, punthoek 135°, met kruisgeslepen punt volgens DIN 1412 C, cilindrisch, extra lang, industriële kwaliteit, voor bijv. gelegeerd en ongelegeerd staal, gietstaal, smeedbaar gietijzer, sinterijzer, non-ferrometaal, harde kunststof.



## HSS-spiraalboren, DIN 338, ZB-kaart

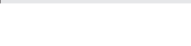

Art.-nr.	Ø mm	Inhoud per pak	Kerngat voor schroefdraadmaat			EAN
<b>ZB-kaart</b>						
209610	1	2			10	
209615	1,5	2			10	
209620	2	2			10	
209625	2,5	2	M 3		10	
209630	3	2	M 3,5		10	
209632	3,2	1			10	
209633	3,3	1	M 4		10	
209635	3,5	1			10	
209640	4	1			10	
209642	4,2	1	M 5		10	
209645	4,5	1			10	
209648	4,8	1			10	
209650	5	1	M 6		10	
209655	5,5	1			10	
209660	6	1	M 7		10	
209665	6,5	1			10	
209668	6,8	1	M 8		10	
209670	7	1			10	
209675	7,5	1			10	
209678	7,8	1	M 9		10	

Rechts snijdend, type N, rolgewalst, kleur blauwzwart, stoomontlaten, punthoek 118°, cilindrisch, voor bijv. gelegeerd en ongelegeerd staal, machinegietijzer, non-ferrometaal, harde kunststof.

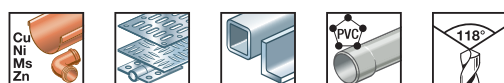

**HSS-spiraalboren, DIN 338, ZB-kaart**



Art.-nr.	Ø mm	Inhoud per pak	Kerngat voor schroefdraadmaat			EAN
209680	8	1			10	4 0093 12 096806
209685	8,5	1	M 10		10	4 0093 12 096851
209690	9	1			10	4 0093 12 096905
209695	9,5	1	M 11		10	4 0093 12 096950
209700	10	1			10	4 0093 12 097001
209705	10,5	1			5	4 0093 12 097051
209710	11	1			5	4 0093 12 097100
209720	12	1	M 14		5	4 0093 12 097209
209730	13	1			5	4 0093 12 097308

**HSS-spiraalboren, DIN 338, los**



Rechts snijdend, type N, rolgewalst, kleur blauwzwart, stoomontlaten, punthoek 118°, cilindrisch, voor bijv. gelegeerd en ongelegeerd staal, machinegietijzer, non-ferrometaal, harde kunststof.







Art.-nr.	Ø mm	Kerngat voor schroefdraadmaat			EAN
<b>Los, zak</b>					
204010	1			Z10	4 0093 12 040106
204015	1,5			Z10	4 0093 12 040151
204020	2			Z10	4 0093 12 040205
204025	2,5	M 3		Z10	4 0093 12 040250
204030	3	M 3,5		Z10	4 0093 12 040304
204032	3,2			Z10	4 0093 12 040321
204033	3,3	M 4		Z10	4 0093 12 040335
204035	3,5			Z10	4 0093 12 040359
204040	4			Z10	4 0093 12 040403
204042	4,2	M 5		Z10	4 0093 12 040427
204045	4,5			Z10	4 0093 12 040458
204050	5	M 6		Z10	4 0093 12 040502
204055	5,5			Z10	4 0093 12 040557
204060	6	M 7		Z10	4 0093 12 040601
204065	6,5			Z10	4 0093 12 040656
204070	7			Z10	4 0093 12 040700
204075	7,5			Z10	4 0093 12 040755
204080	8			Z10	4 0093 12 040809
204085	8,5	M 10		Z10	4 0093 12 040854
204090	9			Z10	4 0093 12 040908
204100	10			Z10	4 0093 12 041004
204105	10,5			Z10	4 0093 12 041059



## HSS-spiraalboren, DIN 338, los







Art.-nr.	Ø mm	Kerngat voor schroefdraadmaat			EAN
204110	11			Z5	
204120	12	M 14		Z5	
204130	13			Z5	



## HSS-spiraalborenset, DIN 338, 19-delig







Art.-nr.	Ø mm	Toename			EAN
421920	1 - 10	0,5		4	

Rechts snijdend, type N, rolgewalst, kleur blauwzwart, stoomontlaten, punthoek 118°, cilindrisch, voor bijv. gelegeerd en ongelegeerd staal, machinegietijzer, non-ferrometaal, harde kunststof.



## HSS-spiraalborenset, DIN 338, 13-delig



Art.-nr.	Ø mm			EAN
424140	2 - 8		6	

Rechts snijdend, type N, rolgewalst, kleur blauwzwart, stoomontlaten, punthoek 118°, cilindrisch, voor bijv. gelegeerd en ongelegeerd staal, machinegietijzer, non-ferrometaal, harde kunststof.



**HSS-spiraalborenset, DIN 338, 10-delig**



Rechts snijdend, type N, rolgewalst, kleur blauwzwart, stoomontlaten, punthoek 118°, cilindrisch, voor bijv. gelegeerd en ongelegeerd staal, machiegietijzer, non-ferrometaal, harde kunststof.

Art.-nr.	Ø mm	Toename			EAN
421340	1 - 10	1		6	4 009314 213409

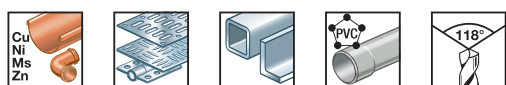

**HSS-spiraalborenset, DIN 338, 6-delig**



Rechts snijdend, type N, rolgewalst, kleur blauwzwart, stoomontlaten, punthoek 118°, cilindrisch, voor bijv. gelegeerd en ongelegeerd staal, machiegietijzer, non-ferrometaal, harde kunststof.

Art.-nr.	Ø mm	Toename			EAN
423140	2, 3, 4, 5, 6, 8			6	4 009314 231403

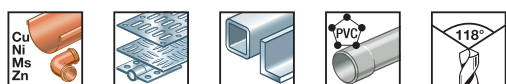

**HSS-spiraalborenset, DIN 338, 13-delig**



Rechts snijdend, type N, rolgewalst, kleur blauwzwart, stoomontlaten, punthoek 118°, cilindrisch, voor bijv. gelegeerd en ongelegeerd staal, machiegietijzer, non-ferrometaal, harde kunststof.

Art.-nr.	Ø mm	Toename			EAN
429040	1,5 - 6,5 plus 3,3 en 4,2	0,5		6	4 009314 290400

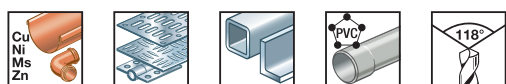

## Combi-borensset, 9-delig



Art.-nr.	Ø mm			EAN
420200	HSS 3, 4, 5, 6, 8 en HM-Steen 4, 5, 6, 8		6	4 009314 202007
420300	HSS 3, 4, 5 en HM-Steen 5, 6, 8 en hout 5, 6, 8		6	4 009314 203004
420400	HSS 4, 6, 8 en HM-Steen 4, 6, 8 en hout 4, 6, 8		6	4 009314 204001

Steen- en houtboren HSS en HM



## HSS-spiraalboren met afgedraaide schacht, ZB-etui met kaart



Art.-nr.	Ø mm	Inhoud per pak			EAN
<b>ZB-etui met kaart</b>					
159105	10,5	1		5	4 009311 591050
159110	11	1		5	4 009311 591104
159120	12	1		5	4 009311 591203
159130	13	1		5	4 009311 591302
159140	14	1		5	4 009311 591401
159150	15	1		5	4 009311 591500
159160	16	1		5	4 009311 591609
159170	17	1		1	4 009311 591708
159180	18	1		1	4 009311 591807
159190	19	1		1	4 009311 591906
159200	20	1		1	4 009311 592002

volgens DIN 338, rechts snijdend, type N, rolgewalst, kleur blauwzwart, stoomontlaten, punthoek 118°, gereduceerde schacht, voor gebruik van grote diameters in gewone boormachines, voor bijv. gelegeerd en ongelegeerd staal, machinegietijzer, non-ferrometalen en harde kunststoffen. Diameter 10,5 - 16 mm voor gebruik in boormachines met een boorhouder met max. 10 mm klembreedte en diameter 17 - 20 mm voor gebruik in boormachines met een boorhouder met max. 13 mm klembreedte.

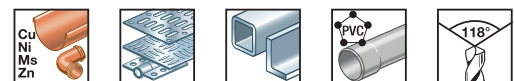

## Spiraalborenslijper



Art.-nr.	Ø mm			EAN
503200	3,5 - 10		2	4 009315 032009

Spiraalborenslijper, voor HSS-boren 3,5-10 mm diameter, metalen uitvoering, punthoekinstelling van 118° vooraf vastgelegd, voor boormachines met 43mm-eurohals.



... altijd de passende toebehoren voor uw machine!



# **BETON- EN STEENBOREN**

**SDS-max-hamerboren**

**SDS-max-beitels**

**SDS-plus-hamerboren**

**SDS-plus-beitels**

**Betonboren**

**Beton- en steenboren**

**Muurdoorvoerboren**

## Beton- en steenboren

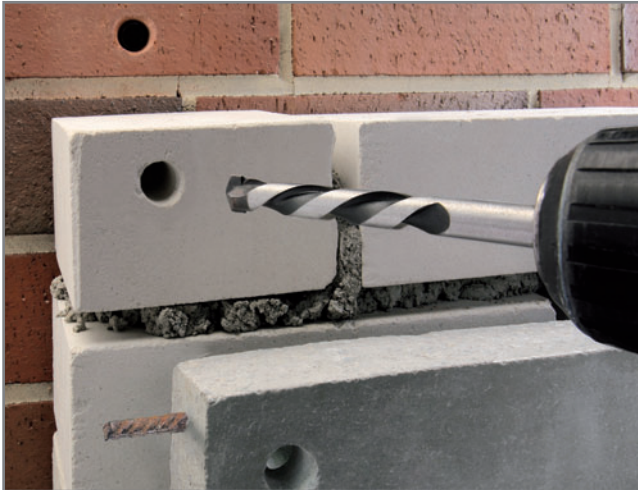

### De voordelen van beton- en steenboren

- Boren met cilindrische schacht voor gebruik in (slag) boormachines
- Boren met SDS-plus-schacht voor gebruik in boorhamers
- Beitel met SDS-plus-schacht voor gebruik in boor- en beitelhamers

## Programma overzicht beton- en steenboren



### SDS-max-hamerboren

★★★★★

Gecertificeerde hamerboor met kop met meer snijkanten, bestand tegen wapening. Ruime stofkanalen voor een wrijvingsloze afvoer van het boorstof.

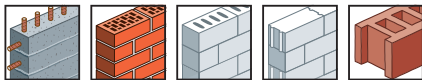

Pagina 32



### SDS-max-beitels voor hamerboren

★★★★★

Voor renovatie, sanering, het maken van doorvoeren en afbraakwerkzaamheden. Voor de hoogste belasting, optimale gewichtsverdeling voor een sterk beitelvermogen.

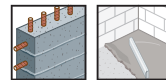

Pagina 32 - 34



### HB 44 SDS-plus-hamerboren

★★★★★

Gecertificeerde hamerboor met meervoudige spiraal voor een optimale boorstofafvoer, geoptimaliseerd voor trillingen.

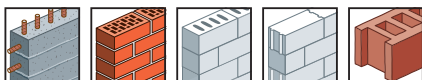

Pagina 35 - 38



### HB 44 SDS-plus-beitels

★★★★★

Voor renovatie en sanering. Voor de hoogste belasting, optimale gewichtsverdeling voor een sterk beitelvermogen.



Pagina 39 - 40

# Beton- en steenboren

## Onze tip: CROSS TIP



### CROSS TIP voor SDS-plus-hamerboren

★★★★★

4-voudige spiraal voor veilige werkzaamheden in gewapend beton, de hardmetalen punt blijft niet vastzitten en breekt niet los.

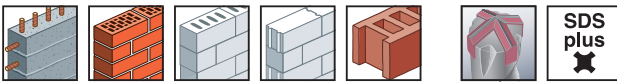

voor



Pagina 41

## kwb-info

### Het kleurcodesysteem van de beton- en steenborenverpakkingen

Met de borenverpakkingen wil kwb doelgerichte consumenteninformatie bieden. Ze vallen op door hun duidelijke kleurcodesysteem dat het te bewerken materiaal aangeeft, en hun ondubbelzinnige toepassingsfoto's.

- SDS MAX / SDS PLUS
- SUPER ROCKER®
- ROCKER®
- BETON- EN STEENBOREN

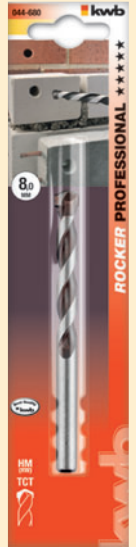

### BOSCH UNEO-boren

★★★★★

Beton- en steenboren, met gepatenteerde SDS-QUICK-schacht, licentie BOSCH.

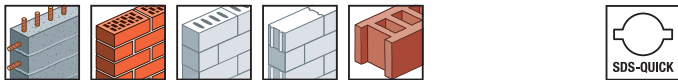

Pagina 42



### SUPER ROCKER® beton- en steenboren

★★★★★

Asymmetrisch gevormde boorspiraal voor een optimale boorstofafvoer. Hamervaste, hoogwaardige beton- en steenboor, voor alle slagboormachines.



Pagina 44 - 45

Opname:



### Steenboren

★★★★★

Spaanloos gevormde halfronde boorspiraal voor een goede boorstofafvoer, voor alle accuschroevendraaiers en boormachines.

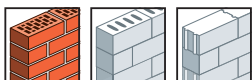

Pagina 45 - 47

Opname:



### Muurdoorvoerboren

★★★★★

Spaanloos gevormde halfronde boorspiraal voor een goede boorstofafvoer, voor alle (slag)boormachines.

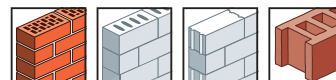

Pagina 47 - 48

Opname:









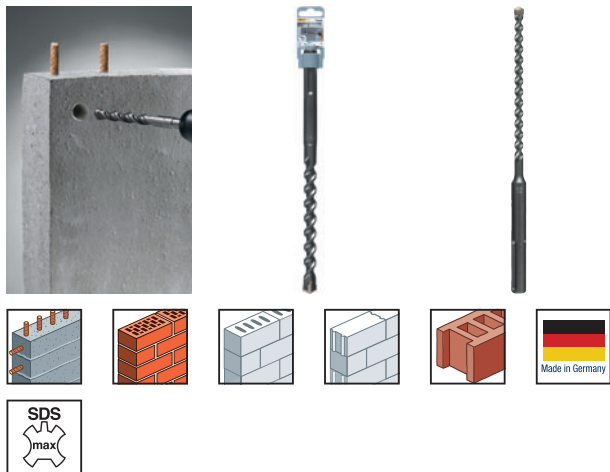























**SDS-max-hamerboren, ZB-clip**



Hamerboren, opnameschacht SDS-max, kop met meer snijkanten, bestand tegen wapening, zelfcenterende boorpunt, ruime stofkanalen voor een wrijvingsloze afvoer van het boorstof en een minimale warmteontwikkeling, geoptimaliseerd voor trillingen, gecertificeerd door PGM (de Duitse Prüfgemeinschaft Mauerbohrer), voldoet aan de eisen van het Deutsche Institut für Bautechnik.









Art.-nr.	 mm	 mm	Ø mm			EAN
<b>ZB-clip</b>						
193412	200	340	12		1	
193414	200	340	14		1	
193415	200	340	15		1	
193416	200	340	16		1	
193418	200	340	18		1	
193730	250	370	30		1	
193732	250	370	32		1	
193740	250	370	40		1	
195220	400	520	20		1	
195222	400	520	22		1	
195224	400	520	24		1	
195225	400	520	25		1	
196912	550	690	12		1	

**SDS-max-beitel, puntbeitel**



Beitels, opnameschacht SDS-max, hoogwaardig speciaal staal, slijtarme gekogelstraalde oppervlakken, optimale gewichtsverdeling voor sterk beitelermogen. Geoptimaliseerd voor trillingen.



Art.-nr.	Lengte			EAN
<b>Puntbeitel, ZB-clip</b>				
190140	400		1	
190160	600		1	

**kwb-Info**

**Geoptimaliseerd voor trillingen, wat betekent dat?**

Een speciaal reflectie-element op de schacht versterkt het vermogen van de kwb-beitels. De terugslagenergie wordt









omgezet in extra slagenergie en zorgt zo voor minder trillingen tijdens het werken.





## SDS-max-beitel, platte beitel











Art.-nr.		Lengte			EAN
<b>Platte beitel, ZB-clip</b>					
190228	25	280		1	
190240	25	400		1	
190260	25	600		1	

Beitels, opnameschacht SDS-max, hoogwaardig speciaal staal, slijtarne gekogelstraalde oppervlakken, optimale gewichtsverdeling voor sterk beitelermogen. Geoptimaliseerd voor trillingen.



## SDS-max-beitel, spadebeitel







Art.-nr.		Lengte			EAN
<b>Spadebeitel, ZB-clip</b>					
190340	50	400		1	
190430	80	300		1	
190530	115	350		1	

Beitels, opnameschacht SDS-max, hoogwaardig speciaal staal, slijtarne gekogelstraalde oppervlakken, optimale gewichtsverdeling voor sterk beitelermogen. Geoptimaliseerd voor trillingen.



## SDS-max-beitel, holle beitel



Art.-nr.		Lengte			EAN
<b>Holle beitel, ZB-clip</b>					
190630	26	300		1	

Beitels, opnameschacht SDS-max, hoogwaardig speciaal staal, slijtarne gekogelstraalde oppervlakken, optimale gewichtsverdeling voor sterk beitelermogen. Geoptimaliseerd voor trillingen.



**SDS-max-beitel, kanaalbeitel**



Beitels, opnameschacht SDS-max, hoogwaardig speciaal staal, slijtarne gekogelstraalde oppervlakken, optimale gewichtsverdeling voor sterk beitelvermogen. Geoptimaliseerd voor trillingen.



Art.-nr.		Lengte			EAN
<b>Kanaalbeitel, ZB-clip</b>					
190730	32	300		1	

**kwb-Info**

**Voor droge wanden bij het boren**

**kwb bouw- en houtvochtmeter**  
Art.-nr. 012100























- Universeel inzetbare meter voor de bepaling van bouw- en houtvocht
- Ideaal bij saneringswerkzaamheden, waterschade en de aankoop van hout
- Groot, gemakkelijk leesbaar lcd-scherm
- Geschikt voor vele materialen
- Met led om donkere meetpunten te verlichten



## HB 44 SDS-plus-hamerboren, 110/50 mm, ZB-clip







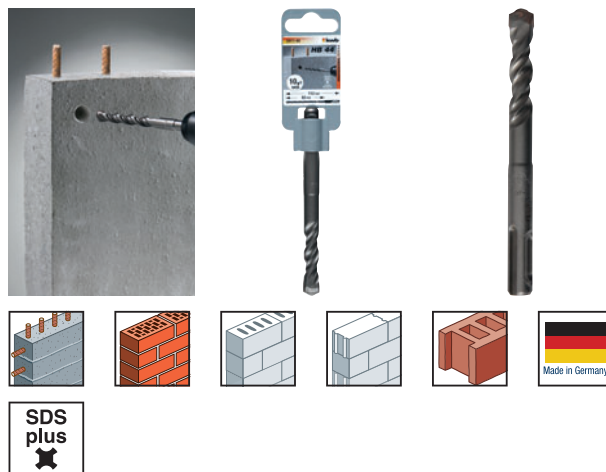



















Art.-nr.			Ø mm			EAN
<b>110/50 mm, ZB-clip</b>						
241134	50	110	4		5	
241135	50	110	5		5	
241136	50	110	6		5	
241137	50	110	7		5	
241138	50	110	8		5	
241140	50	110	10		5	
241185	50	110	5,5		5	
241195	50	110	6,5		5	

Hamerboren, opnameschacht SDS-plus, zelfcenterende boorpunt, bij hoge temperatuur gesoldeerd, meervoudige spiraal voor een optimale boorstofafvoer, minimale wrijving met de wand en minimale warmteontwikkeling, geoptimaliseerd voor trillingen, gecertificeerd door PGM (de Duitse Prüfgemeinschaft Mauerbohrer), voldoet aan de eisen van het Deutsche Institut für Bautechnik.



## HB 44 SDS-plus-hamerboren, 160/100 mm, ZB-clip



Art.-nr.			Ø mm			EAN
<b>160/100 mm, ZB-clip</b>						
241635	100	160	5		5	
241685	100	160	5,5		5	
241636	100	160	6		5	
241695	100	160	6,5		5	
241637	100	160	7		5	
241638	100	160	8		5	
241640	100	160	10		5	
241642	100	160	12		1	
241644	100	160	14		1	
241645	100	160	15		1	

Hamerboren, opnameschacht SDS-plus, zelfcenterende boorpunt, bij hoge temperatuur gesoldeerd, meervoudige spiraal voor een optimale boorstofafvoer, minimale wrijving met de wand en minimale warmteontwikkeling, geoptimaliseerd voor trillingen, gecertificeerd door PGM (de Duitse Prüfgemeinschaft Mauerbohrer), voldoet aan de eisen van het Deutsche Institut für Bautechnik.

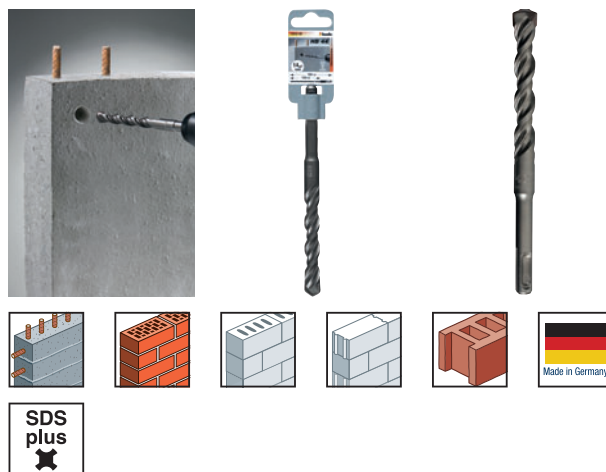

**HB 44 SDS-plus-hamerboren, 210/150 mm, ZB-clip**



Hamerboren, opnameschacht SDS-plus, zelfcentrerende boorpunt, bij hoge temperatuur gesoldeerd, meervoudige spiraal voor een optimale boorstofafvoer, minimale wrijving met de wand en minimale warmteontwikkeling, geoptimaliseerd voor trillingen, gecertificeerd door PGM (de Duitse Prüfgemeinschaft Mauerbohrer), voldoet aan de eisen van het Deutsche Institut für Bautechnik.

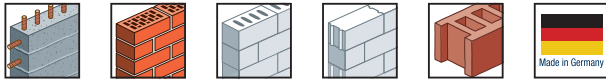

Art.-nr.			Ø mm			EAN
<b>210/150 mm, ZB-clip</b>						
242136	150	210	6		1	
242138	150	210	8		1	
242140	150	210	10		1	
242142	150	210	12		1	
242144	150	210	14		1	
242146	150	210	16		1	
242148	150	200	18		1	
242150	150	200	20		1	

**HB 44 SDS-plus-hamerboren, 260/200 mm, ZB-clip**





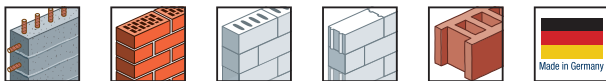















Hamerboren, opnameschacht SDS-plus, zelfcentrerende boorpunt, bij hoge temperatuur gesoldeerd, meervoudige spiraal voor een optimale boorstofafvoer, minimale wrijving met de wand en minimale warmteontwikkeling, geoptimaliseerd voor trillingen, gecertificeerd door PGM (de Duitse Prüfgemeinschaft Mauerbohrer), voldoet aan de eisen van het Deutsche Institut für Bautechnik.



Art.-nr.			Ø mm			EAN
<b>260/200 mm, ZB-clip</b>						
242636	200	260	6		1	
242638	200	260	8		1	
242640	200	260	10		1	
242642	200	260	12		1	
242644	200	260	14		1	
242645	200	260	15		1	
242652	200	260	22		1	
242654	200	260	24		1	

## HB 44 SDS-plus-hamerboren, 310/250 mm, ZB-clip







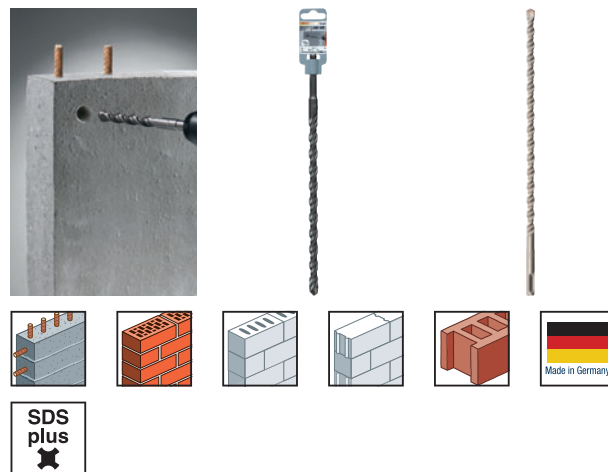

















Art.-nr.			Ø mm			EAN
<b>310/250 mm, ZB-clip</b>						
243136	250	310	6		1	
243138	250	310	8		1	
243140	250	310	10		1	
243144	250	310	14		1	
243146	250	310	16		1	
243148	250	310	18		1	
243150	250	310	20		1	

Hamerboren, opnameschacht SDS-plus, zelfcentrerende boorpunt, bij hoge temperatuur gesoldeerd, meervoudige spiraal voor een optimale boorstofafvoer, minimale wrijving met de wand en minimale warmteontwikkeling, geoptimaliseerd voor trillingen, gecertificeerd door PGM (de Duitse Prüfgemeinschaft Mauerbohrer), voldoet aan de eisen van het Deutsche Institut für Bautechnik.



## HB 44 SDS-plus-hamerboren, 460/400 mm, ZB-clip

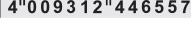

Art.-nr.			Ø mm			EAN
<b>460/400 mm, ZB-clip</b>						
244638	400	460	8		1	
244640	400	460	10		1	
244642	400	460	12		1	
244644	400	460	14		1	
244646	400	460	16		1	
244648	400	450	18		1	
244650	400	450	20		1	
244652	400	450	22		1	
244654	400	450	24		1	
244655	400	450	25		1	



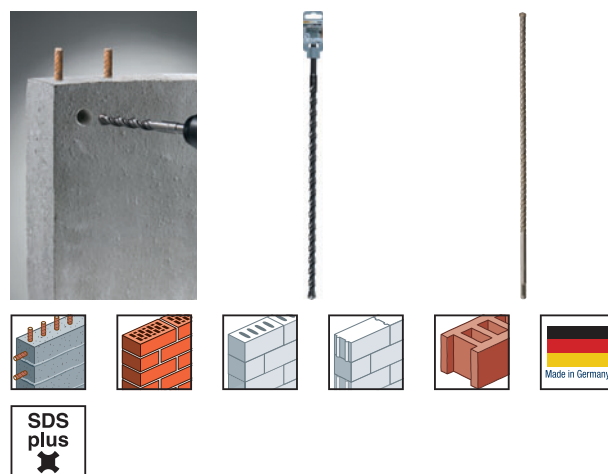



Hamerboren, opnameschacht SDS-plus, zelfcentrerende boorpunt, bij hoge temperatuur gesoldeerd, meervoudige spiraal voor een optimale boorstofafvoer, minimale wrijving met de wand en minimale warmteontwikkeling, geoptimaliseerd voor trillingen, gecertificeerd door PGM (de Duitse Prüfgemeinschaft Mauerbohrer), voldoet aan de eisen van het Deutsche Institut für Bautechnik.



**HB 44 SDS-plus-hamerborenset, 7-delig**



Hamerboren, opnameschacht SDS-plus, zelfcentrerende boorpunt, bij hoge temperatuur gesoldeerd, meervoudige spiraal voor een optimale boorstofafvoer, minimale wrijving met de wand en minimale warmteontwikkeling, geoptimaliseerd voor trillingen, gecertificeerd door PGM (de Duitse Prüfgemeinschaft Mauerbohrer), voldoet aan de eisen van het Deutsche Institut für Bautechnik.



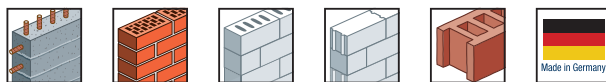







Art.-nr.			Ø mm			EAN
240700	50/100	110/160	5, 6, 8 + 6, 8, 10, 12		1	 4 0093 12 407008



**HB 44 SDS-plus-hamerborensets, 4-delig**





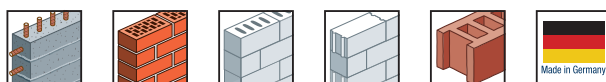

Hamerboren, opnameschacht SDS-plus, zelfcentrerende boorpunt, bij hoge temperatuur gesoldeerd, meervoudige spiraal voor een optimale boorstofafvoer, minimale wrijving met de wand en minimale warmteontwikkeling, geoptimaliseerd voor trillingen, gecertificeerd door PGM (de Duitse Prüfgemeinschaft Mauerbohrer), voldoet aan de eisen van het Deutsche Institut für Bautechnik.

Art.-nr.			Ø mm			EAN
240400	50	110	5, 6, 8, 10		2	 4 0093 12 404007
240500	50/100	110/180	5, 6, 8, 10		1	 4 0093 12 405004
240800	100	160	5, 6, 8, 10		1	 4 0093 12 408005



## SDS-plus-beitel voor boorhamer, puntbeitel







Art.-nr.	 mm			EAN
<b>Puntbeitel, ZB-clip</b>				
247210	250		1	

Beitels, opnameschacht SDS-plus, hoogwaardig speciaal staal, slijtarne gekogelstraalde oppervlakken, optimale gewichtsverdeling voor sterk beitelermogen. Geoptimaliseerd voor trillingen.



## SDS-plus-beitel voor boorhamer, platte beitel







Art.-nr.	 mm			EAN
<b>Platte beitel, ZB-clip</b>				
247302	250		1	

Beitels, opnameschacht SDS-plus, hoogwaardig speciaal staal, slijtarne gekogelstraalde oppervlakken, optimale gewichtsverdeling voor sterk beitelermogen. Geoptimaliseerd voor trillingen.



## SDS-plus-beitel voor boorhamer, spadebeitel



Art.-nr.	 mm			EAN
<b>Spadebeitel, ZB-clip</b>				
247304	250		1	

Beitels, opnameschacht SDS-plus, hoogwaardig speciaal staal, slijtarne gekogelstraalde oppervlakken, optimale gewichtsverdeling voor sterk beitelermogen. Geoptimaliseerd voor trillingen.







**SDS-plus-beitel voor boorhamer,gleufbeitel**



Beitels, opnameschacht SDS-plus, hoogwaardig speciaal staal, slijtarme gekogelstraalde oppervlakken, optimale gewichtsverdeling voor sterk beitelvermogen. Geoptimaliseerd voor trillingen.







Art.-nr.	 mm			EAN
<b>Kanaalbeitel, ZB-clip</b>				
247410	250		1	 4 009312 474109

**SDS-plus-beitel voor boorhamer, tegelbeitel**



Beitels, opnameschacht SDS-plus, hoogwaardig speciaal staal, slijtarme gekogelstraalde oppervlakken, optimale gewichtsverdeling voor sterk beitelvermogen. Geoptimaliseerd voor trillingen.



Art.-nr.	 mm			EAN
<b>Tegelbeitel, ZB-clip</b>				
247504	250		1	 4 009312 475045

**kwb-Info**

**Altijd de juiste beitel van kwb !**



**Puntbeitel/  
platte beitel**

- beitel- en afbraakwerkzaamheden in metselwerk en beton
- Aanpassingswerkzaamheden in metselwerk en beton
- Renovatie van voegen
- Vrijmaken van wapening



**Spadebeitel**

- Verwijderen van pleisterlagen en vuil
- Verwijderen van betonresten op bekistingsplaten
- Sanering van staal



**Kanaalbeitel**

- Aanbrengen van kanalen in metselwerk



































**Tegelbeitel**

- Verwijderen van wand- en vloertegels



## CROSS-TIP hamerboren, punt 4-snijder, ZB-clip



Art.-nr.		Ø mm			EAN
<b>ZB-clip</b>					
260504	110	4		1	4 0093 12 605046
260505	110	5		1	4 0093 12 605053
260506	110	6		1	4 0093 12 605060
260508	110	8		1	4 0093 12 605084
260510	110	10		1	4 0093 12 605107
260555	110	5,5		1	4 0093 12 605558
261005	160	5		1	4 0093 12 610057
261006	160	6		1	4 0093 12 610064
261007	160	7		1	4 0093 12 610071
261008	160	8		1	4 0093 12 610088
261010	160	10		1	4 0093 12 610101
261012	160	12		1	4 0093 12 610125
261014	160	14		1	4 0093 12 610149
261506	210	6		1	4 0093 12 615069
261508	210	8		1	4 0093 12 615083
261510	210	10		1	4 0093 12 615106
261512	210	12		1	4 0093 12 615120
261514	210	14		1	4 0093 12 615144
262006	260	6		1	4 0093 12 620063
262008	260	8		1	4 0093 12 620087
262010	260	10		1	4 0093 12 620100
262012	260	12		1	4 0093 12 620124
262014	260	14		1	4 0093 12 620148
264010	460	10		1	4 0093 12 640108
264012	460	12		1	4 0093 12 640122
264014	460	14		1	4 0093 12 640146
264016	450	16		1	4 0093 12 640160
264018	450	18		1	4 0093 12 640184
264020	450	20		1	4 0093 12 640207

Hamerboren, opnameschacht voor SDS-plus, CROSS-Tip-punt, 4-snijder, optimaal te gebruiken in gewapend beton, blokkeert niet, bij hoge temperatuur gesoldeerd, meervoudige spiraal voor een optimale boorstofafvoer, materiaalvriendelijk boren en hoge krachtoverdracht met gering trilling en een rustig boorverloop. Ideaal voor het boren van pluggaten of voor bevestigingstechnieken in betonnen muren.



voor



**Betonboren voor Bosch UNEO, SDS-quick-schacht, ZB-kaart**



Beton- en steenboren, opnameschacht SDS-QUICK, met hardmetaal versterkt, bij hoge temperatuur gesoldeerd, voor BOSCH UNEO. Ook bruikbaar in gangbare (slag)boormachines en lichte voorhamers.

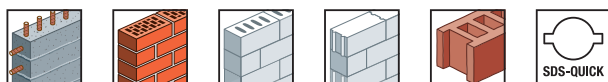

Art.-nr.	Ø mm			EAN
<b>ZB-kaart</b>				
035640	4		5	4 009310 356407
035650	5		5	4 009310 356506
035660	6		5	4 009310 356605
035680	8		5	4 009310 356803
035700	10		5	4 009310 357008

**ROCKER<sup>®</sup> beton- en -steenboren, ISO 5468, ZB-kaart**



Beton- en steenboren, volgens ISO 5468, met hardmetaal versterkt, bij hoge temperatuur gesoldeerd, breed en diep gesteunde hardmetalen plaat, verspanend, asymmetrisch gevormde boorspiraal voor een optimale boorstofafvoer, hamervaste hoogwaardige boor voor alle slijpmachines, kleur zwart gebruineerd blank, gepolijst oppervlak, voor graniet, beton, metselwerk, natuur- en kunststeen, kalkzandsteen.

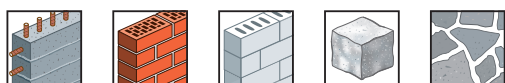
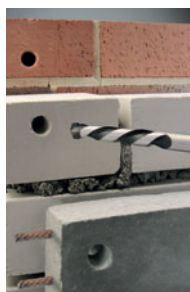

Art.-nr.	Ø mm			EAN
<b>ZB-kaart</b>				
044630	3		10	4 009310 446306
044640	4		10	4 009310 446405
044650	5		10	4 009310 446504
044655	5,5		10	4 009310 446559
044660	6		10	4 009310 446603
044670	7		10	4 009310 446702
044680	8		10	4 009310 446801
044700	10		10	4 009310 447006
044720	12		5	4 009310 447204
044740	14		5	4 009310 447402
044760	16		5	4 009310 447600

**kwb-Info**

**Een kwestie van veiligheid**

Ons oog is een van onze belangrijkste zintuigen en moet dus bij alle werkzaamheden worden beschermd. Daarom heeft kwb voor alle gangbare binnen- en buitentoeepassingen, zoals boren, frezen, slijpen en lassen, een hoogwaardig, ook voor bril dragers geschikt















assortiment veiligheidsbrillen samengesteld.



[www.kwb.eu](http://www.kwb.eu)

## ROCKER® beton- en steenboren, ISO 5468, lange uitvoering, ZB-kaart







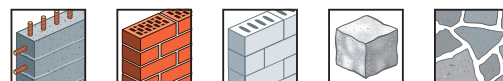

Art.-nr.		Ø mm				EAN
<b>ZB-kaart</b>						
045050	150	5	cil.		5	
045060	150	6	cil.		5	
045080	250	8	cil.		5	
045100	250	10	cil.		5	
045120	250	12	10		5	

Beton- en steenboren, volgens ISO 5468, met hardmetaal versterkt, bij hoge temperatuur gesoldeerd, breed en diep gesteunde hardmetalen plaat, verspanend, asymmetrisch gevormde boorspiraal voor een optimale boorstofafvoer, hamervaste hoogwaardige boor voor alle slijpmachines, kleur zwart gebruineerd blank, gepolijst oppervlak, voor graniet, beton, metselwerk, natuur- en kunststeen, kalkzandsteen.



## ROCKER® beton- en -steenborenssets, ISO 5468, 4- en 5-delig



Art.-nr.	Ø mm			EAN
044300	3, 4, 5, 6, 8		6	
044800	5, 6, 8, 10		6	

Beton- en steenboren, volgens ISO 5468, met hardmetaal versterkt, bij hoge temperatuur gesoldeerd, breed en diep gesteunde hardmetalen plaat, verspanend, asymmetrisch gevormde boorspiraal voor een optimale boorstofafvoer, hamervaste hoogwaardige boor voor alle slijpmachines, kleur zwart gebruineerd blank, gepolijst oppervlak, voor graniet, beton, metselwerk, natuur- en kunststeen, kalkzandsteen.

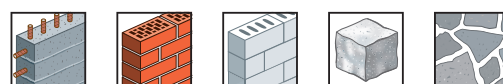

**ROCKER<sup>®</sup> beton- en -steenborenset, ISO 5468**



Beton- en steenboren, volgens ISO 5468, met hardmetaal versterkt, bij hoge temperatuur gesoldeerd, breed en diep gesteunde hardmetalen plaat, verspanend, asymmetrisch gevormde boorspiraal voor een optimale boorstofafvoer, hamervaste hoogwaardige boor voor alle slijpmachines, kleur zwart gebruineerd blank, gepolijst oppervlak, voor graniet, beton, metselwerk, natuur- en kunststeen, kalkzandsteen.

Art.-nr.	Ø mm			EAN
044568	5, 6, 8		6	4 009310 445682

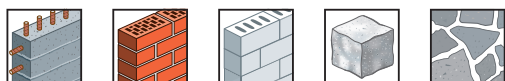
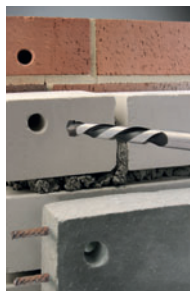

**SUPER ROCKER<sup>®</sup> 6-kantbeton- en -steenboren, ISO 5468, ZB-kaart**



Beton- en steenboren, volgens ISO 5468, met hardmetaal versterkt, bij hoge temperatuur gesoldeerd, breed en diep gesteunde hardmetalen plaat, 6-kantopnameschacht, verspanend, asymmetrisch gevormde boorspiraal voor een optimale boorstofafvoer, hamervaste hoogwaardige boor voor alle slijpmachines, kleur zwart gebruineerd blank, gepolijst oppervlak, voor graniet, beton, metselwerk, natuur- en kunststeen, kalkzandsteen.

Art.-nr.	Ø mm	mm			EAN
<b>ZB-kaart</b>					
050640	4	3,1		10	4 009310 506406
050650	5	3,9		10	4 009310 506505
050655	5,5	3,9		10	4 009310 506550
050660	6	4,7		10	4 009310 506604
050670	7	5,6		10	4 009310 506703
050680	8	6		10	4 009310 506802
050700	10	7,7		10	4 009310 507007
050720	12	8,4		5	4 009310 507205
050740	14	9,3		5	4 009310 507403
050760	16	9,3		5	4 009310 507601

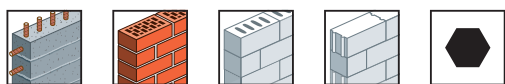
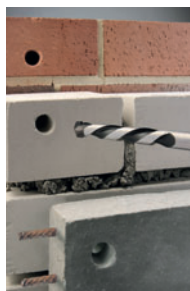

## SUPER ROCKER® 6-kantbeton- en -steenborenset, ISO 5468, 4-delig



Art.-nr.	Ø mm	Inhoud per pak			EAN
050800	5, 6, 8, 10	4		1	4 009310 508004

Beton- en steenboren, volgens ISO 5468, met hardmetaal versterkt, bij hoge temperatuur gesoldeerd, breed en diep gesteunde hardmetalen plaat, 6-kantopnameschacht, verspanend, asymmetrisch gevormde boorspiraal voor een optimale boorstofafvoer, hamervaste hoogwaardige boor voor alle slijpmachines, kleur zwart gebruineerd blank, gepolijst oppervlak, voor graniet, beton, metselwerk, natuur- en kunststeen, kalkzandsteen.

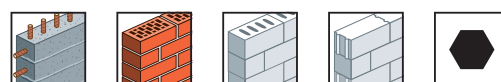

## Steenboren met zeskanthouder 1/4", E 6.3



Art.-nr.			Ø mm			EAN
421004	30	45	4		10	4 009314 210040
421005	45	60	5		10	4 009314 210057
421006	50	75	6		10	4 009314 210064

Steenboren, 1/4"-zeskanthouder volgens ISO 1173, E 6.3, met hardmetaal versterkt, bij hoge temperatuur gesoldeerd, halfronde boorspiraal voor een goede boorstofafvoer, voor alle accuschroevendraaiers, boormachines en bithouders met 1/4"-houder volgens ISO 1173, kleur zwart gebruineerd, blank geslepen oppervlakken, voor metselwerk, natuur- en kunststeen en kalkzandsteen.

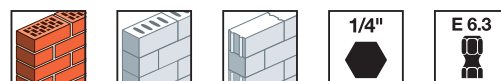

## kwb-Info

### Een kwestie van veiligheid

Er zijn veel werkzaamheden waarbij stof en fijnstof opwaait, dampen en gassen ontstaan of met andere gezondheidsschadelijke stoffen wordt omgegaan. Bescherm bij alle werkzaamheden uw luchtwegen tegen deze gevaren.

Hiervoor heeft kwb een omvangrijk assortiment veiligheidsmaskers, met en zonder ademventielen.

Voor alle gangbare toepassingen in de voorgeschreven beschermingsklassen.



[www.kwb.eu](http://www.kwb.eu)

**Steenboren, ISO 5468, ZB-kaart**



Steenboren, volgens ISO 5468, met hardmetaal versterkt, bij hoge temperatuur gesoldeerd, spaanloos gevormde halfronde boorspiraal voor een goede boorstofafvoer, slagboorvaste boren voor alle (slag)boormachines, gekogelstraald oppervlak, kleur grijs, voor metselwerk, natuur- en kunststeen en kalkzandsteen.

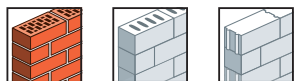

Art.-nr.	Ø mm	T mm			EAN
<b>ZB-kaart</b>					
039630	3	cil.		10	4 0093 10 3963 04
039640	4	cil.		10	4 0093 10 3964 03
039650	5	cil.		10	4 0093 10 3965 02
039655	5,5	cil.		10	4 0093 10 3965 57
039660	6	cil.		10	4 0093 10 3966 01
039665	6,5	cil.		10	4 0093 10 3966 56
039670	7	cil.		10	4 0093 10 3967 00
039680	8	cil.		10	4 0093 10 3968 09
039700	10	cil.		10	4 0093 10 3970 04
039720	12	10		5	4 0093 10 3972 02
039740	14	10		5	4 0093 10 3974 00
039760	16	12		1	4 0093 10 3976 08

**Steenborenssets, 5- en 8-delig, ISO 5468**





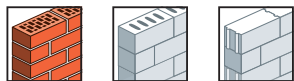

Steenboren, volgens ISO 5468, met hardmetaal versterkt, bij hoge temperatuur gesoldeerd, spaanloos gevormde halfronde boorspiraal voor een goede boorstofafvoer, slagboorvaste boren voor alle (slag)boormachines, gekogelstraald oppervlak, kleur grijs, voor metselwerk, natuur- en kunststeen en kalkzandsteen.



Art.-nr.	Ø mm	Inhoud per pak			EAN
039500	4, 5, 6, 8, 10	5		6	4 0093 10 3950 00
039800	3, 4, 5, 6, 7, 8, 9, 10	8		6	4 0093 10 3980 01

## Steenborenssets, ISO 5468, hardmetalenpunt, 5- en 8-delig















Art.-nr.	Ø mm	Inhoud per pak			EAN
038500	4, 5, 6, 8, 10	5		6	4 009310 385001
038900	3, 4, 5, 6, 7, 8, 9, 10	8		6	4 009310 389009

Steenborensset, volgens ISO 5468, met hardmetaal versterkt, slagboorvaste boren voor alle (slag)boormachines.



## PROFESSIONELE muurdoorvoerboren, 200 mm, ZB-etui met kaart



Art.-nr.		Ø mm	Max. rpm				EAN
<b>200 mm ZB-etui met kaart</b>							
041055	200	5,5	1.600	cil.		5	4 009310 410550
041006	200	6	1.600	cil.		5	4 009310 410062
041065	200	6,5	1.600	cil.		5	4 009310 410659
041007	200	7	1.600	cil.		5	4 009310 410079
041008	200	8	1.600	cil.		5	4 009310 410086
041010	200	10	1.200	cil.		5	4 009310 410109
041012	200	12	1.200	cil.		5	4 009310 410123
041014	200	14	800	10		1	4 009310 410147
041016	200	16	800	10		1	4 009310 410161

Muurdoorvoerboren, volgens ISO 5468, met hardmetaal versterkt, bij hoge temperatuur gesoldeerd, spaanloos gevormde halfronde boorspijraal voor een goede boorstofafvoer, slagboorvaste boren voor alle (slag) boormachines, gekogelstraald oppervlak, kleur grijs, voor metselwerk, natuur- en kunststeen en kalkzandsteen.



## kwb-Info

### Een kwestie van veiligheid

Tijdens doe-het-zelven, werkzaamheden in de bouw of bij sport en recreatie worden de voorgeschreven geluidsgrenswaarden meestal overschreden. Zonder bescherming kan het gehoor beschadigd raken. Daarvoor heeft kwb een assortiment gehoorbescherming samengesteld voor alle gangbare toepassingen,

van eenvoudige oordoppen tot en met professionele oorkappen.

[www.kwb.eu](http://www.kwb.eu)









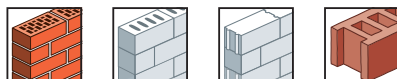











**PROFESSIONELE muurdoorvoerboren, 400 mm, ZB-etui met kaart**



Muurdoorvoerboren, volgens ISO 5468, met hardmetaal versterkt, bij hoge temperatuur gesoldeerd, spaanloos gevormde halfronde boorspijraal voor een goede boorstofafvoer, slagboorvaste boren voor alle (slag) boormachines, gekogelstraald oppervlak, kleur grijs, voor metselwerk, natuur- en kunststeen en kalkzandsteen.



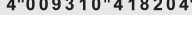







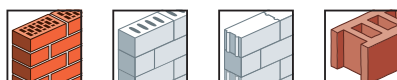







Art.-nr.	 mm	Ø mm	Max. rpm	 mm			EAN
<b>400 mm ZB-etui met kaart</b>							
041806	400	6	650	cil.		1	 4 009310 418068
041808	400	8	650	cil.		1	 4 009310 418082
041810	400	10	650	cil.		1	 4 009310 418105
041812	400	12	500	cil.		1	 4 009310 418129
041814	400	14	500	10		1	 4 009310 418143
041816	400	16	500	○10		1	 4 009310 418167
041818	400	18	300	○10		1	 4 009310 418181
041820	400	20	300	○11		1	 4 009310 418204

**PROFESSIONELE muurdoorvoerboren, 600 mm, ZB-etui met kaart**



Muurdoorvoerboren, volgens ISO 5468, met hardmetaal versterkt, bij hoge temperatuur gesoldeerd, spaanloos gevormde halfronde boorspijraal voor een goede boorstofafvoer, slagboorvaste boren voor alle (slag) boormachines, gekogelstraald oppervlak, kleur grijs, voor metselwerk, natuur- en kunststeen en kalkzandsteen.







Art.-nr.	 mm	Ø mm	Max. rpm	 mm			EAN
<b>600 mm ZB-etui met kaart</b>							
041610	600	10	650	cil.		1	 4 009310 416101
041612	600	12	500	cil.		1	 4 009310 416125
041614	600	14	500	10		1	 4 009310 416149
041616	600	16	500	○10		1	 4 009310 416163
041618	600	18	300	○10		1	 4 009310 416187
041620	600	20	300	○11		1	 4 009310 416200

**Stofvanger**



Stofvanger voor alle steenboren met diameter van 4-10 mm, om het boorstof eenvoudig op te vangen tijdens het boren in steen en beton in muren en plafonds.

Art.-nr.	Ø mm			EAN
045400	4 - 10		1	 4 009310 454004





# SPECIALE BOREN

EASY CUT universele boren

Gres

Glasboren



## Speciale boren



### De voordelen van de speciale boren

- Universele boren voor boormachines en met SDS-schacht voor gebruik in hamerboren. Voor universeel gebruik in hout, metaal, tegels, keramiek, steen en kunststof
- Glasboren voor gebruik in glas, keramiek en tegels
- Gresboren voor bijzonder harde grestegels

## Programma overzicht EASY CUT universele boren



### EASY CUT universele boren SDS Plus ★★★★★

Voor alle SDS-boorhamers met slagstop, met MS 5-boorspiraal, extra harde hardmetalen wolfram-titaanpunt, met diamant geslepen snijvlakken.

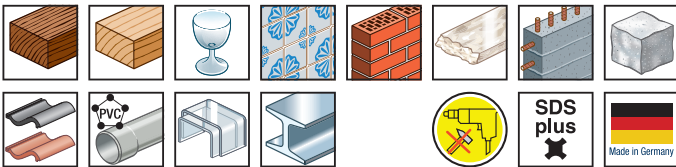

Pagina 52



### EASY CUT universele boren ★★★★★



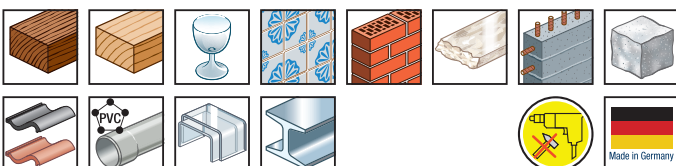







Voor alle (slag)boormachines, extra harde hardmetalen wolfram-titaanpunt, met diamant geslepen snijvlakken.



Pagina 52 - 53



### Richtwaarden voor EASY CUT universele boren

	Diameter in mm		Materiaal
	4	16	
Omwentelingen per minuut	2350	1500	 Zacht hout
	1880	1030	 Keramiek
	1580	800	     Metselwerk, marmer, kunststeen, beton, graniet, dakpannen, kunststof, acryl
	1120	640	 Staal, gietstaal
	1700	510	 Hardhout
	850	410	 Glas, kristal

## kwb-info

### Het kleurcodesysteem van de verpakkingen voor speciale boren

Met de borenverpakkingen wil kwb doelgerichte consumenteninformatie bieden. Ze vallen op door hun duidelijke kleurcode-systeem dat het te bewerken materiaal aangeeft, en hun ondubbelzinnige toepassings-foto's.

- EASY CUT UNIVERSELE
- GRES
- GLAS

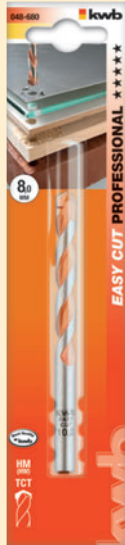

## Programma overzicht gresboren en glasboren



### Gresboren

★★★★★

Voor alle (slag)boormachines, dankzij de waterkoeling verhoogt de boorsnelheid en de levensduur van de boren.



Pagina 53 - 54



### Glasboren

★★★★★

Voor alle (slag)boormachines, voldoende koelen met water, terpentijn of petroleum.



Pagina 55

## kwb-info

### Een kwestie van veiligheid



Ons oog is een van onze belangrijkste zintuigen en moet dus bij alle werkzaamheden worden beschermd.

Daarom heeft kwb voor alle gangbare binnen- en buitentoepassingen, zoals boren, frezen, slijpen en lassen, een hoogwaardig, ook voor brildragers geschikt assortiment veiligheidsbrillen samengesteld.

Alle informatie hierover vindt u in onze kwb-folder voor arbeidsveiligheid of op het internet op [www.kwb.eu](http://www.kwb.eu).







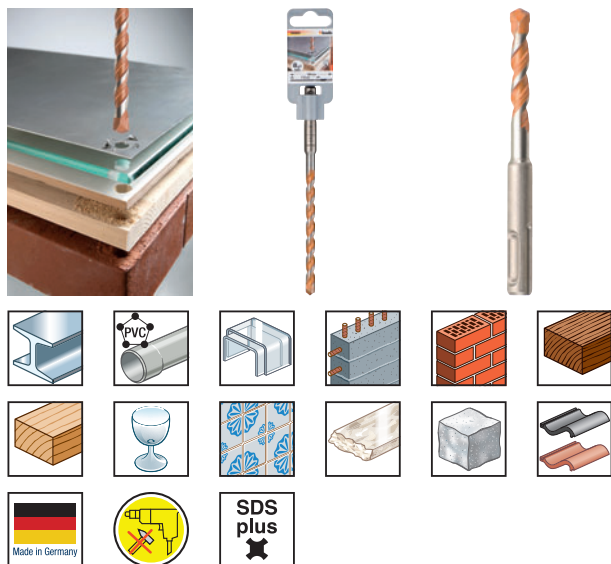

**EASY CUT universele hamerboren met SDS-plus-schacht**



Universele boren, SDS-plus-opnameschacht, met hardmetaal versterkt, extra harde hardmetalen wolfram-titaanpunt, met diamant geslepen snijvlakken, bij hoge temperatuur gesoldeerd, verspanend, MS 5-boorspiraal voor een optimale boorstofafvoer, voor alle SDS-plus-hamerboren met slagstop, kleur koper blank, geslepen oppervlakken, voor metselwerk, marmer, kunststeen, beton, graniet, dakpannen, keramiek, hard- en zacht hout, kunststof, acryl, gelegeerd en ongelegeerd staal, glas en kristal.











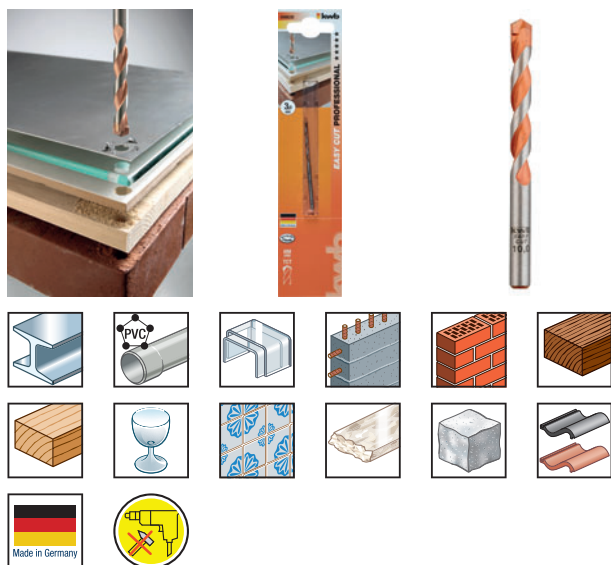

Art.-Nr.	Inhoud per pak			EAN
<b>ZB-clip</b>				
266105	5,0 x 50 x 110 mm		1	4 0093 12 661059
266606	6,0 x 110 x 160 mm		1	4 0093 12 666061
266608	8,0 x 110 x 160 mm		1	4 0093 12 666085
266610	10,0 x 110 x 160 mm		1	4 0093 12 666108
266612	12,0 x 110 x 160 mm		1	4 0093 12 666122

**EASY CUT universele boren**



Universele boren, met hardmetaal versterkt, extra harde hardmetalen wolfram-titaanpunt, met diamant geslepen snijvlakken, bij hoge temperatuur gesoldeerd, verspanend, asymmetrisch gevormde boorspiraal voor een optimale boorstofafvoer, voor alle (slag)boormachines, kleur koper blank, geslepen oppervlakken, voor metselwerk, marmer, kunststeen, beton, graniet, dakpannen, keramiek, hard- en zacht hout, kunststof, acryl, gelegeerd en ongelegeerd staal, glas en kristal.



Art.-Nr.	Ø mm			EAN
<b>ZB-kaart</b>				
048630	3		10	4 0093 10 486302
048640	4		10	4 0093 10 486401
048650	5		10	4 0093 10 486500
048660	6		10	4 0093 10 486609
048670	7		10	4 0093 10 486708
048680	8		10	4 0093 10 486807
048700	10		10	4 0093 10 487002
048720	12		10	4 0093 10 487200

## EASY CUT universele borenset, 5-delig



Art.-Nr.	Ø mm			EAN
048300	3, 4, 5, 6, 8		6	 4 009310 483004

Universele boren, met hardmetaal versterkt, extra harde hardmetalen wolfram-titaanpunt, met diamant geslepen snijvlakken, bij hoge temperatuur gesoldeerd, verspanend, asymmetrisch gevormde boorspiraal voor een optimale boorstofafvoer, voor alle (slag)boormachines, kleur koper blank, geslepen oppervlakken, voor metselwerk, marmer, kunststeen, beton, graniet, dakpannen, keramiek, hard- en zacht hout, kunststof, acryl, gelegeerd en ongelegeerd staal, glas en kristal.



**Gresboren, ZB-kaart**



Gresboren, met hard metaal versterkt, extra harde hardmetalen wolfraam-titaanpunt, TSM-plaat, met diamant geslepen snijvlakken, bij hoge temperatuur gesoldeerd, verspanend, asymmetrisch gevormde boorspijraal voor een optimale boorstofafvoer, voor alle (slag)boormachines, kleur blauw, voor tegels en gres tot krashardheid 9, keramiek, dakpannen.

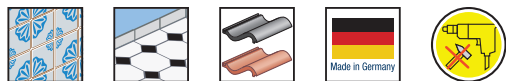
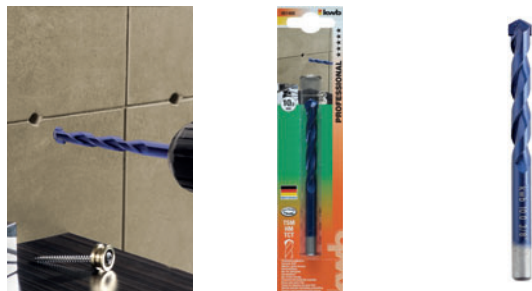

Art.-nr.	Ø mm			EAN
<b>ZB-kaart</b>				
051340	4		1	4 009310 513404
051350	5		1	4 009310 513503
051360	6		1	4 009310 513602
051380	8		1	4 009310 513800
051400	10		1	4 009310 514005

**Gresborenset, 4-delig**



Gresboren, met hard metaal versterkt, extra harde hardmetalen wolfraam-titaanpunt, TSM-plaat, met diamant geslepen snijvlakken, bij hoge temperatuur gesoldeerd, verspanend, asymmetrisch gevormde boorspijraal voor een optimale boorstofafvoer, voor alle (slag)boormachines, kleur blauw, voor tegels en gres tot krashardheid 9, keramiek, dakpannen.

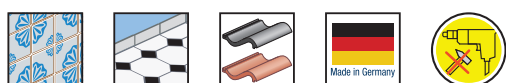

Art.-nr.	Ø mm			EAN
051300	4, 5, 6, 8		1	4 009310 513008

**kwb-Info**

**Voor grotere gaten in gres**

Daarvoor heeft kwb geschikte diamantgatenzagen voor gres en harde tegels voor het boren van pluggaten, doorvoeren voor wateraansluitingen en waterafvoerbuizen en gaten voor de inbouw van verdeler- en contactdozen.

Deze producten vindt u in onze catalogus op pagina 132.



# Speciale boren

## Glasboren, ZB-kaart



Art.-nr.	Ø mm			EAN
<b>ZB-kaart</b>				
177003	3		6	
177004	4		6	
177005	5		6	
177006	6		6	
177007	7		6	
177008	8		6	
177010	10		1	
177012	12		1	

Glasboren, met hardmetaal versterkt, speciaal en kruisgeslepen plaat, voor alle (slag)boormachines, kleur blank gechromateerd, voor glas, porselein, tegels tot krashardheid 8 en keramiek.



## Glasborensset, 5-delig



Art.-nr.	Ø mm			EAN
177000	4, 5, 6, 8, 10		1	

Glasboren, met hardmetaal versterkt, speciaal en kruisgeslepen plaat, voor alle (slag)boormachines, kleur blank gechromateerd, voor glas, porselein, tegels tot krashardheid 8 en keramiek.

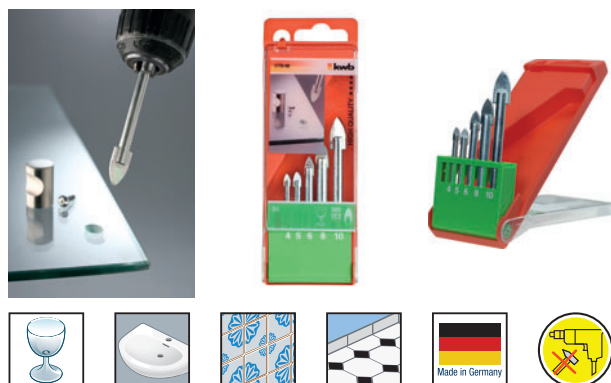

**Hardmetalen cirkelsnijder, traploos instelbaar**



Hardmetalen cirkelsnijder, met hardmetaal versterkt, snijarm traploos van 20-90 mm instelbaar, schachtdiameter 9 mm, voor tegels, dakpannen, pleister en kunststof.

Art.-nr.	Ø mm			EAN
178100	20 - 90		2	4 009311 781000

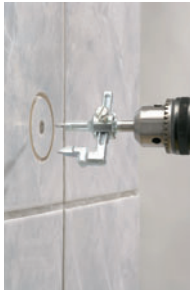

**Hardmetalen cirkelsnijder met beschermkorf**



Hardmetalen cirkelsnijder, met hardmetaal versterkt, snijarm traploos van 20-90 mm instelbaar, schachtdiameter 9 mm, voor tegels, dakpannen, pleister en kunststof.

Art.-nr.	Ø mm			EAN
178200	20 - 90 veiligheidsuitvoering met beschermkorf		1	4 009311 782007





# HOUTBOREN

Hardhoutboren

Houtboren

Balkenboren

Slangschroefboren

Scharniergatboren

Speedboren



## Houtboren



### De voordelen van de houtboren

- Houtboren voor elke houtsoort en toepassing
- Boren in zacht hout en hardhout
- Bij de constructie van terrassen, binnenafbouw, constructiebouw of bekistingwerkzaamheden

## Programma overzicht houtboren



### FCE-hardhoutboren

★★★★★

Met gepatenteerde centreerpunt voor zuivere boorgatranden zonder brandsporen en HSS-M2-spiraal met TwinLand®-groefdesign, voor een snelle boorstofafvoer en tot 6-maal sneller boren in zacht- en hardhout zoals bankirai enz.

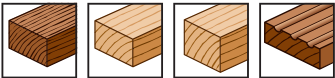

Pagina 60



### HSS-hardhoutboren

★★★★★

HSS-hardhoutboren met verstelbare dieptestop en verzinker, ideaal voor het voorbereiden van hardhout bij de plaatsing van terrassen of andere houten tuinelementen.

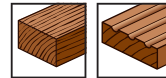

Pagina 60



### Houtboren met dubbele spiraal

★★★★★

Dubbele spiraal voor een ronde, gelijkmatige loop en dus precieze boringen in zacht- en hardhout.

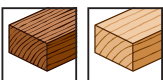

Pagina 61



### Houtspiraalboren voor balken, extra lang

★★★★

250 en 400 mm, specifiek voor balken in constructiebouw, voor alle (slag) boormachines met 13mm-houder, voor hard- en zacht hout, lichte bouwmaterialen en gipsplaten

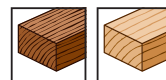

Pagina 64

## Houtboren



### Bekistingsboren

★★★★★

400 en 600 mm, voor bekistingsbouw, binnenafbouw, verwarmingswerkzaamheden en elektrische installatiewerkzaamheden. In CV- en HSS-uitvoering.



Pagina 64 - 65



### Slangenboren, 235 en 460 mm

★★★★★

Boorkop met zelfcentrerende schroefdraadpunt en voorsnijder. Speciale boorkopvorm voor minder wrijvingsweerstand, massieve kern en wrijvingsloze spiraal voor rechte boringen bij extra hoge spaanafvoer.

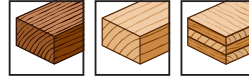

Pagina 66



### Scharniergatboren

★★★★★

Voor het voorbereiden van kastbeslag in meubelbouw.

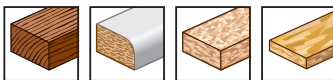

Pagina 67



### Forstnerboren

★★★★★

Precisieboren voor zuivere boorgaten in hard- en zacht hout. Ook bij grote diameters.

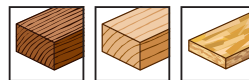

Pagina 68



### Speedboren

★★★★★

Met centreerpunt en 2 voorsnijders om precies te boren in zacht- en hardhout.



Pagina 69



### Centerboren

★★★★★

Met centerpunt en 2 verstelbare snijmessen om precies te boren in zacht- en hardhout.

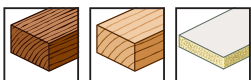

Pagina 70

## kwb-info

### Het kleurcodesysteem van de houtborenverpakkingen

Met de borenverpakkingen wil kwb doelgerichte consumenteninformatie bieden. Ze vallen op door hun duidelijke kleurcodesysteem dat het te bewerken materiaal aangeeft, en hun ondubbelzinnige toepassingsfoto's.

- HARDHOUTBOREN
- HOUTSPIRAALBOREN
- SLANGENBOREN
- SPEEDBOREN
- BEKISTINGSBOREN
- BALKENBOREN









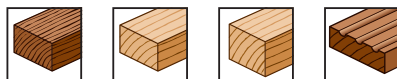











**FCE-hardhoutboren met TwinLand<sup>®</sup>-groefdesign, ZB-kaart**



FCE-houtspiraalboren, HSS-M2, precisiegeslepen, met TwinLand<sup>®</sup>-groefdesign, kleur blank, met gepatenteerde centreerpunt en 2 voorsnijders, speciaal geslepen voor zuivere boorgaten zonder brandsporen, cilindrische schacht, industriële kwaliteit, voor bankirai, hardhout en zacht hout, boort tot 6-maal sneller in hardhout.









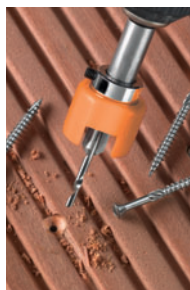

Art.-nr.		Ø mm			EAN
<b>ZB-kaart</b>					
511903	61	3		10	
511904	75	4		10	
511905	86	5		10	
511906	93	6		10	
511907	109	7		10	
511908	117	8		10	
511909	125	9		10	
511910	133	10		10	

**HSS-M2-hardhoutboren met verstelbare dieptestop en verzinker, ZB-kaart**



Hardhoutboren, HSS-M2, met verstelbare dieptestop en verzinker, dieptestop met kogellager, draait niet mee bij aanslag, voorkomt groefvorming op het houtoppervlak, 1/4"-zeskantschacht volgens ISO 1173, E 6.3, voor bankirai, hardhout en zacht hout, ideaal voor het voorbereiden van hardhout bij de plaatsing van terrassen of andere houten tuinelementen, altijd gelijkmatige boor- en verzinkdiepte.



Art.-nr.	Ø mm			EAN
<b>ZB-kaart</b>				
512004	4		1	
512005	5		1	
512006	6		1	

**Voor droog hout bij het boren**

- Universeel inzetbare meter voor de bepaling van bouw- en houtvocht
- Ideaal bij saneringswerkzaamheden, waterschade en de aankoop van hout
- Groot, gemakkelijk leesbaar lcd-scherm
- Geschikt voor vele materialen
- Met led om donkere meetpunten te verlichten



**kwb bouw- en houtvochtmeter**  
**Art.-nr. 012100**

## Houtspiraalboren, ZB-kaart



Art.-nr.	Ø mm	T mm	Icon 1	Icon 2	EAN
<b>ZB-kaart</b>					
511463	3	cil.	Icon 1	10	4 009315 114637
511464	4	cil.	Icon 1	10	4 009315 114644
511465	5	cil.	Icon 1	10	4 009315 114651
511466	6	cil.	Icon 1	10	4 009315 114668
511467	7	cil.	Icon 1	10	4 009315 114675
511468	8	cil.	Icon 1	10	4 009315 114682
511470	10	cil.	Icon 1	10	4 009315 114705
511472	12	8	Icon 1	5	4 009315 114729
511473	13	8	Icon 1	5	4 009315 114736
511474	14	10	Icon 1	5	4 009315 114743
511475	15	10	Icon 1	5	4 009315 114750
511476	16	10	Icon 1	5	4 009315 114767
511477	17	10	Icon 1	5	4 009315 114774

Houtspiraalboren, CV-staal, spaanloos gevormd, dubbele spiraal, voor een stabiele en rechte uitloop, kleur zwart, blank geslepen spiralen, met centreerpunt en schouderrijder, voor precieze en scheurvrije boringen, cilindrische schacht, industriële kwaliteit, voor zacht- en hardhout.



## Houtspiraalborenset, CV-staal, dubbele spiraal, 5-, 7- en 8-delig



Art.-nr.	Ø mm	Inhoud per pak	Icon 1	Icon 2	EAN
514000	4, 5, 6, 8, 10	5	Icon 1	6	4 009315 140001
514100	3, 4, 5, 6, 7, 8, 9, 10	8	Icon 1	6	4 009315 141008
514200	3, 4, 5, 6, 8, 10, 1 verzinker 90	7	Icon 1	6	4 009315 142005

Houtspiraalboren, CV-staal, spaanloos gevormd, dubbele spiraal, voor een stabiele en rechte uitloop, kleur zwart, blank geslepen spiralen, met centreerpunt en schouderrijder, voor precieze en scheurvrije boringen, cilindrische schacht, industriële kwaliteit, voor zacht- en hardhout.















Houtspiraalboren met zeskanthouder 1/4", E 6.3, ZB-kaart



Houtspiraalboren, CV-staal, zeskanthouder 1/4"-houder volgens ISO 1173, E 6.3, spaanloos gevormd, kleur zwart, blank geslepen spiralen, met centreerpunt en 2 voorsnijders, voor precieze en scheurvrije boringen, voor alle accuschroefmachines, boormachines en bithouders met 1/4"-houder volgens ISO 1173, voor zacht- en hardhout.



Art.-nr.			Ø mm			EAN
<b>ZB-kaart</b>						
513903	35	40	3		10	
513904	40	50	4		10	
513905	50	60	5		10	
513906	55	65	6		10	



Houtborenset, 5-delig



Houtspiraalboren, CV-staal, zeskanthouder 1/4"-houder volgens ISO 1173, E 6.3, spaanloos gevormd, kleur zwart, blank geslepen spiralen, met centreerpunt en 2 voorsnijders, voor precieze en scheurvrije boringen, voor alle accuschroefmachines, boormachines en bithouders met 1/4"-houder volgens ISO 1173, voor zacht- en hardhout.

Art.-nr.	Ø mm			EAN
513900	3, 4, 5, 6, 8		6	



## Houtboren met verzinker













Art.-nr.	Ø mm			EAN
512604	4,5 + 7,0		6	

Houtboren, HSS-M2, spiraalboren met verzinker WS, voor het plaatsen van verzonken houtschroeven, voorboren met 4,5 mm diameter en extra 7 mm diameter en 11 mm verzinken, geschikt voor IKEA-schroeven, voor zacht- en hardhout, beklede en niet-beklede spaanplaten, kunststof.



## Houtspiraalborenset met opsteekverzinker en dieptestop, 3-delig



Art.-nr.	Ø mm			EAN
513103	3		5	
513104	4		5	
513105	5		5	
513106	6		5	

Houtspiraalboren, CV-staal, met verstelbare opsteekverzinker 5-snijder WS en dieptestop, cilindrische schacht, voor zacht- en hardhout.

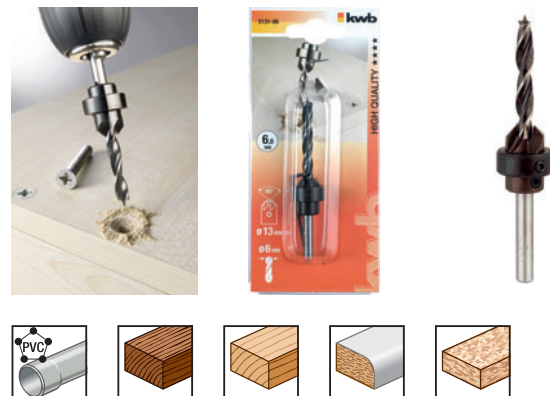

## kwb-Info

### Een kwestie van veiligheid

Veiligheidshandschoenen dienen te worden gedragen bij alle toepassingen waarbij handletsels kunnen optreden, bijv. in de bouw, bij voorwerpen met scherpe randen enz. Bij alle werkzaamheden zijn grip en optimaal draagcomfort basisvoorwaarden voor de juiste veiligheidshandschoenen.

Alle informatie hierover vindt u in onze kwb-folder voor arbeidsveiligheid of op het internet op [www.kwb.eu](http://www.kwb.eu)









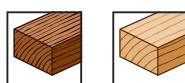

**Balkenboren, houtspiraalboren, extra lang, 250 mm, ZB-etui met kaart**



Houtspiraalboren, extra lang, CV-staal, spaanloos gevormd, enkelvoudige spiraal, kleur zwart, blank geslepen fase, met centreerpunt en 2 voorsnijders, voor precieze en scheurvrije boringen in houten balken, industriële kwaliteit, voor zacht- en hardhout.











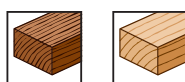





Art.-nr.		Ø mm	T mm			EAN
<b>250 mm ZB-etui met kaart</b>						
511806	250	6	cil.		5	
511808	250	8	cil.		5	
511810	250	10	cil.		5	
511812	250	12	10		5	
511814	250	14	10		5	
511816	250	16	10		5	
511818	250	18	13		5	
511820	250	20	13		5	

**Balkenboren, houtspiraalboren, extra lang, 400 mm, ZB-etui met kaart**



Houtspiraalboren, extra lang, CV-staal, spaanloos gevormd, enkelvoudige spiraal, kleur zwart, blank geslepen fase, met centreerpunt en 2 voorsnijders, voor precieze en scheurvrije boringen in houten balken, industriële kwaliteit, voor zacht- en hardhout.

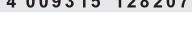

Art.-nr.		Ø mm	T mm			EAN
<b>400 mm ZB-etui met kaart</b>						
512810	400	10	cil.		5	
512812	400	12	10		1	
512814	400	14	10		1	
512816	400	16	10		1	
512818	400	18	13		1	
512820	400	20	13		1	

**Bekistingsboren, HSS-staal**



Bekistings- en installatieboren, HSS-staal, boorpunt 118° volgens DIN 7490, boorkop en schachttuiteinde geschroefd en gelijmd en dus zeer weinig breukgevaar, verbeterde concentriciteit, klemt niet vast in vochtig hout, voor alle (slag)boormachines met 13mm-houder, voor sandwichmateriaal met staal-, aluminium- of profielplaten, bekistingshout, hard- en zacht hout, lichte bouwstoffen, gipsplaten.

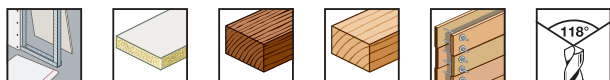
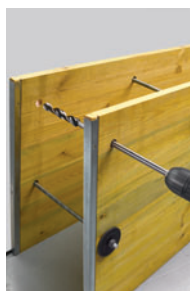

























Art.-nr.		Ø mm	T mm			EAN
<b>400 mm ZB-etui met kaart</b>						
043606	400	6	6		1	
043608	400	8	7		1	
043610	400	10	8		1	
043612	400	12	10		1	
043614	400	14	10		1	
043616	400	16	10		1	
043618	400	18	12		1	
043620	400	20	12		1	



## Bekistingsboren, 400 mm, ZB-etui met kaart







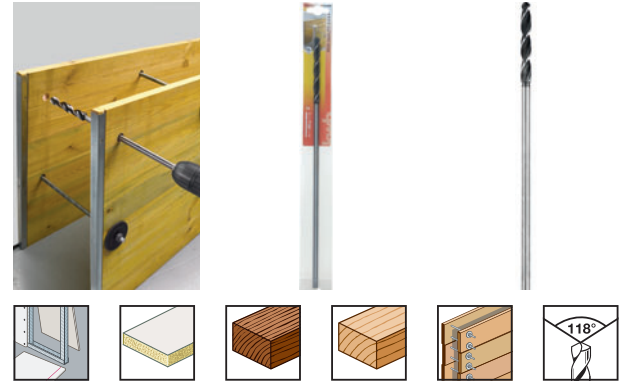

















Art.-nr.		Ø mm				EAN
<b>400 mm ZB-etui met kaart</b>						
043206	400	6	6		1	
043208	400	8	7		1	
043210	400	10	8		1	
043212	400	12	10		1	
043214	400	14	10		1	
043216	400	16	10		1	
043218	400	18	12		1	
043220	400	20	12		1	
043222	400	22	13		1	
043225	400	25	13		1	

Bekistings- en installatieboren, CV-staal, boorpunt 118°, boorkop en schachtuiteinde geschroefd en gelijmd en dus zeer weinig breukgevaar, verbeterde concentriciteit, klemt niet vast in vochtig hout, voor alle (slag) boormachines met 13mm-houder, voor bekistingshout, hard- en zacht-hout, lichte bouwstoffen, gipsplaten.



## Bekistingsboren, 600 mm, ZB-etui met kaart



Art.-nr.		Ø mm				EAN
<b>600 mm ZB-etui met kaart</b>						
043408	600	8	7		1	
043410	600	10	8		1	
043412	600	12	10		1	
043414	600	14	10		1	
043416	600	16	10		1	
043418	600	18	12		1	
043420	600	20	12		1	
043422	600	22	13		1	
043425	600	25	13		1	

Bekistings- en installatieboren, CV-staal, boorpunt 118°, boorkop en schachtuiteinde geschroefd en gelijmd en dus zeer weinig breukgevaar, verbeterde concentriciteit, klemt niet vast in vochtig hout, voor alle (slag) boormachines met 13mm-houder, voor bekistingshout, hard- en zacht-hout, lichte bouwstoffen, gipsplaten.

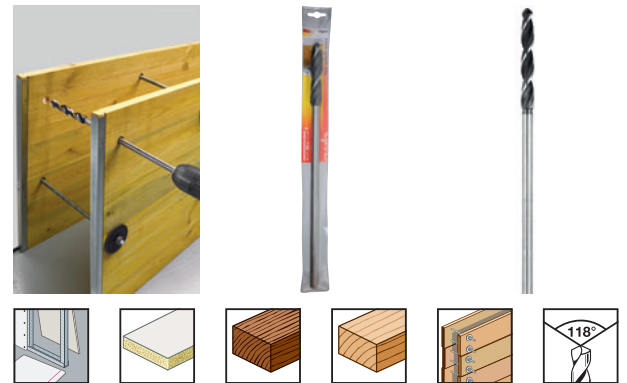







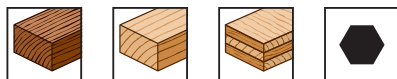























**Slangschroefboren, 235 mm, ZB-etui met kaart**



Slangschroefboren, CV-staal, 6-kanthouder, precisiegeslepen, kleur zwart, blank geslepen, boorkop met zelfborende schroefdraadpunt voor snelle boringen met weinig krachtinspanning, precisiegeslepen hoofdsnijder, voorsnijder, voor precieze boringen in houten balken en dakconstructies, industriële kwaliteit, voor gebruik in afbouwbedrijven, bij timmerlui en dakdekkers.











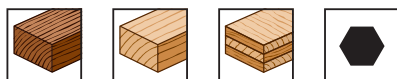























Art.-nr.			Ø mm				EAN
<b>235 mm ZB-etui met kaart</b>							
042206	160	235	6	6		1	
042208	160	235	8	6		1	
042210	160	235	10	6		1	
042212	160	235	12	6		1	
042214	160	235	14	6		1	
042216	160	235	16	10		1	
042218	160	235	18	10		1	
042220	160	235	20	10		1	
042222	160	235	22	10		1	
042224	160	235	24	10		1	
042226	160	235	26	10		1	
042228	160	235	28	10		1	
042230	160	235	30	10		1	

**Slangschroefboren, 460 mm, ZB-etui met kaart**



Slangschroefboren, CV-staal, 6-kanthouder, precisiegeslepen, kleur zwart, blank geslepen, boorkop met zelfborende schroefdraadpunt voor snelle boringen met weinig krachtinspanning, precisiegeslepen hoofdsnijder, voorsnijder, voor precieze boringen in houten balken en dakconstructies, industriële kwaliteit, voor gebruik in afbouwbedrijven, bij timmerlui en dakdekkers.



Art.-nr.			Ø mm				EAN
<b>460 mm ZB-etui met kaart</b>							
042406	390	460	6	6		1	
042408	390	460	8	8		1	
042410	390	460	10	8		1	
042412	390	460	12	10		1	
042414	390	460	14	10		1	
042416	390	460	16	10		1	
042418	390	460	18	10		1	
042420	390	460	20	10		1	
042422	390	460	22	10		1	
042424	390	460	24	10		1	
042426	390	460	26	10		1	
042428	390	460	28	10		1	
042430	390	460	30	10		1	

## HM-scharniergatboren



Art.-nr.	Ø mm	T mm			EAN
705930	35	8		1	4 009317 059301

Scharniergatboren, met hardmetaal versterkt, voor het voorbereiden van kastbeslag, voor hardhout, houten platen met kunststof coating, spaan- en meubelplaten.

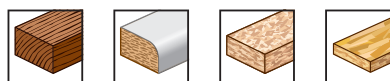

## Scharniergatboren



Art.-nr.	Ø mm	T mm			EAN
705510	26	8		1	4 009317 055105
705520	30	8		1	4 009317 055204
705530	35	8		1	4 009317 055303

Scharniergatboren, speciaal staal, voor het voorbereiden voor kastbeslag, voor hard- en zacht hout en meubelplaten.

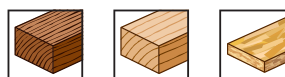

## Pensnijderset, 3-delig



Art.-nr.		Ø mm	T mm			EAN
706900	17	10, 12, 16	8		2	4 009317 069003

Pensnijder, precisiegeslepen snijder, voor het maken van exact passende cilindrische pennen, dankzij de extra lange vorm met open zijkant kunnen lange pennen gesneden en eenvoudig losgemaakt worden, bijzonder geschikt voor schrijnwerkerijen, meubelmakerijen en standbouw, voor zacht hout.

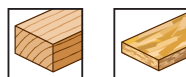

**Forstnerboren, ZB-kaart**



Forstnerboren, volgens D 7483 G, houtbewerking, speciaal edelstaal, boorkop gesmeed en geslepen, 2 hoofdsnijkmanten en 2 zijsnijkmanten, centreerpunt, kleur blank met zwarte groeven, zuivere boorgatranden, voor alle (slag)boormachines met 10-/13mm-houder, voor hard- en zacht hout, fineer en meubelplaten. Zuivere boorgatranden, ook bij grote diameters.

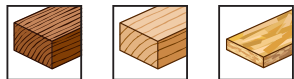

Art.-nr.	Ø mm	T mm			EAN
<b>ZB-kaart</b>					
706010	10	8		1	4 009317 060109
706012	12	8		1	4 009317 060123
706015	15	8		1	4 009317 060154
706016	16	8		1	4 009317 060161
706018	18	8		1	4 009317 060185
706020	20	8		1	4 009317 060208
706022	22	8		1	4 009317 060222
706025	25	8		1	4 009317 060253
706026	26	8		1	4 009317 060260
706030	30	8		1	4 009317 060307
706035	35	10		1	4 009317 060352
706040	40	10		1	4 009317 060406
706045	45	10		1	4 009317 060451
706050	50	10		1	4 009317 060505

**Forstnerborensset, 5-delig**





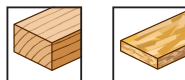













































Forstnerboren, volgens D 7483 G, houtbewerking, speciaal edelstaal, boorkop gesmeed en geslepen, 2 hoofdsnijkmanten en 2 zijsnijkmanten, centreerpunt, kleur blank met zwarte groeven, zuivere boorgatranden, voor alle (slag)boormachines met 10-/13mm-houder, voor hout- en meubelplaten. Zuivere boorgatranden, ook bij grote diameters.



Art.-nr.	Ø mm	Inhoud per pak			EAN
706000	15, 20, 25, 30, 35	5		1	4 009317 060000

## Vlakfreesboren PROFESSIONEEL, ZB-kaart



Art.-nr.	∅ mm	T mm			EAN
<b>ZB-kaart</b>					
512406	6	6		5	
512408	8	6		5	
512410	10	6		5	
512412	12	6		5	
512413	13	6		5	
512414	14	6		5	
512416	16	6		5	
512417	17	6		5	
512418	18	6		5	
512419	19	6		5	
512420	20	6		5	
512422	22	6		1	
512424	24	6		1	
512425	25	6		1	
512426	26	6		1	
512428	28	6		1	
512430	30	6		1	
512432	32	6		1	
512434	34	6		1	
512435	35	6		1	
512436	36	6		1	
512438	38	6		1	
512440	40	6		1	

Vlakfreesboren, houtbewerking, 1/4"-zeskantschacht volgens ISO 1173, E 6.3, met centreerpunt en 2 voorsnijders, speciale snijkantvorm, precies geslepen, om veilig en precies te boren, kleur grijs, gezandstraald, nauwkeurig boren met weinig krachtingspanning, voor zacht- en hardhout en lichte bouwmaterialen.

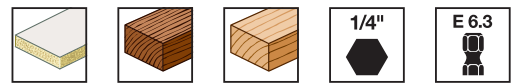

## kwb-Info

### Voor gladde oppervlakken en randen

Ruwe randen en splinters na het boren kunnen moeiteloos worden weggeschuurd met het kwb-handschuurblok van kurk. Dat natuurproduct is het klassieke materiaal voor handschuurblokken, die met alle soorten schuurpapier kunnen worden gebruikt. Bijzonder geschikt voor kleine oppervlakken.

Meer schuurmiddelen vindt u in het overeenkomstige hoofdstuk op pagina 151 in onze catalogus.



**Vlakfreesborenset, 7-delig**



Vlakfreesboren, houtbewerking, 1/4"-zeskantschacht volgens ISO 1173, E 6.3, met centreerpunt en 2 voorsnijders, speciale snijkantvorm, precies geslepen, om veilig en precies te boren, kleur grijs, gezandstraald, nauwkeurig boren met weinig krachtinspanning, voor zacht- en hardhout en lichte bouwmaterialen.

Art.-nr.	Ø mm	Inhoud per pak			EAN
512250	10, 12, 16, 18, 20, 22, 24	7		1	4 009315 122502

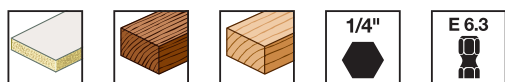

**Vlakfreesboorverlengstuk**



Verlengstuk voor vlakfreesboren, voor 1/4"-zeskantschacht volgens ISO 1173, E 6.3, kleur gebruinteerd.

Art.-nr.	Houder	mm			EAN
512400	6 mm	300		2	4 009315 124001
512450	1/4" E en C 6.3	300		1	4 009315 124506



**Centerboren**



Centerboren, houtbewerking, cilindrische schacht, met centreerpunt, verstelbaar, met 2 snijmesses, diameter 15-25 mm en 25-45 mm, kleur grijs, gezandstraald, voor zacht- en hardhout en lichte bouwmaterialen.

Art.-nr.	mm			EAN
175440	15 - 45		1	4 009311 754400

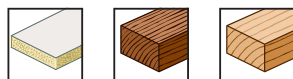

**IMPAKTOR**  
Diamond

# BITS

**IMPAKTOR-bits**

**DIAMANT-bits**

**TITAAN-bits**

**ISO-Temp bits**

**Schroevendraaierbits**

**POWER BOX bitboxen**

## Bits



### De voordelen van de bits

- Hoogwaardige bits voor alle toepassingen
- Speciale bits voor extreme omstandigheden tot standaard bits voor individuele toepassingen
- Zeer nauwkeurig passend
- Optimale hardheid
- Handy bitbox van kwb, gepatenteerd, praktisch klein, handig, ook bruikbaar als schroevendraaier

## Programma overzicht bits



### IMPAKTOR-bits

★★★★★

De sterkste bits voor de extreemste eisen, bijzonder geschikt voor de impact-/slagschroefmachines.



Pagina 74 - 75



### DIAMANT-bits

★★★★★

Vermindert de kans op losschieten en beperkt de aandrukkraft. Moeiteloos werken.



Pagina 79 - 80



### TITAAN-bits

★★★★★

Hoogwaardige oppervlakte afwerking voor een beperkte wrijving en een lange levensduur bij maximale continue belasting.



Pagina 81 - 83



### ISO-TEMP bits

★★★★★

Met geribde ACR-punt die voorkomt dat de bit uit de schroef los schiet, waardoor minder druk hoeft worden uitgeoefend. Moeiteloos werken. Speciale bit voor moeilijke schroefwerkzaamheden, duidelijk beperkte breukgevaar.



Pagina 84 - 85



Gebruiks informatie

Vlak DIN 2380	Philips / Kruis DIN 8764	Pozidriv DIN 8764	Torx DIN EN ISO 10664	Tamper Torx DIN EN ISO 10664	6-Kant DIN 2351



RVS-Bits

★★★★★

Voor het vastschroeven van rvs-schroeven om roestpunten door afslijting te voorkomen. Ideaal voor alle schroefverbindingen buiten, bijv. bij de constructie van terrassen.



Pagina 86



Standaard bits

★★★★★

Voor alle standaard schroefwerkzaamheden.



Pagina 87 - 89



Standaard bits, speciale vormen

★★★★★

Voor alle standaard schroefwerkzaamheden.



Pagina 90 - 93



Bitboxen

★★★★★

Voor individuele toepassingen.

Pagina 94 - 98

... altijd de passende toebehoren voor uw machine!

## Impaktor bits van kwb zijn bestand tegen de harde schroef omstandigheden van impact-/slagschroefmachines



Conventionele bits en houders zijn niet gemaakt voor extreme omstandigheden en verslijten bij dergelijk gebruik zeer snel.

Alle kwb Impaktor-bits hebben diamantdeeltjes op de bitpunt, bijten zich in de schroef vast en verminderen de cam-out-krachten, die tot het losschieten uit de schroefkop kunnen leiden. Hierdoor vermindert de benodigde aandrukkracht bij het machinaal schroeven. Ook doeltreffend bij TORX<sup>®</sup>.



### kwb Impaktor bits voor alle impact-/slagschroevendraaiers in de gangbare maten 25 mm en 50 mm

kwb Impaktor bits hebben naargelang de aandrijfkracht een tot 5 keer langere levensduur dan conventionele of torsiebits.

De kwb Impaktor bits zijn bijzonder geschikt voor gebruik met normale impact-/slagschroevendraaiers.

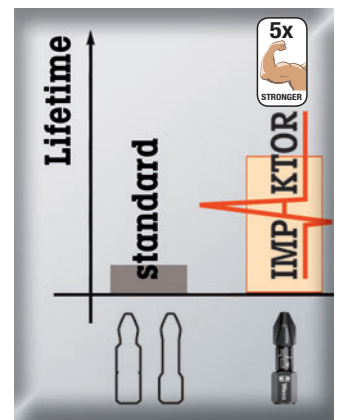

Levensduurvergelijking met conventionele bits

### Impaktor bits voor extreme omstandigheden, 25 en 50 mm



De Impaktor technologie zorgt door een optimale benutting van de materiaaleigenschappen en door optimaal aangepaste geometrieën voor een buitengewone levensduur, ook bij extreme omstandigheden; bijzonder geschikt voor gebruik met normale impact-/slagschroefmachines. De ruwe diamantlaag zorgt voor een verhoogde wrijvingsweerstand en vermindert zo de kans dat de bit uit de schroefkop losschiet.

Art.-nr.	Inhoud	📦	📦	EAN
105502	Impaktor bits PH 2 x 25 mm SB	📦	5	4 0 093 11 055026
105503	Impaktor bits PH 3 x 25 mm SB	📦	5	4 0 093 11 055033
105552	Impaktor bits PH 2 x 50 mm SB	📦	5	4 0 093 11 055521
105553	Impaktor bits PH 3 x 50 mm SB	📦	5	4 0 093 11 055538
105602	Impaktor bits PZ 2 x 25 mm SB	📦	5	4 0 093 11 056023
105603	Impaktor bits PZ 3 x 25 mm SB	📦	5	4 0 093 11 056030
105652	Impaktor bits PZ 2 x 50 mm SB	📦	5	4 0 093 11 056528
105653	Impaktor bits PZ 3 x 50 mm SB	📦	5	4 0 093 11 056535
105720	Impaktor bits TX 20 x 25 mm SB	📦	5	4 0 093 11 057204
105725	Impaktor bits TX 25 x 25 mm SB	📦	5	4 0 093 11 057259
105730	Impaktor bits TX 30 x 25 mm SB	📦	5	4 0 093 11 057303
105740	Impaktor bits TX 40 x 25 mm SB	📦	5	4 0 093 11 057402

## Impaktor bits / impaktor bithouder

# Impaktor bithouder van kwb met ringmagneet en snapring voor alle impact-/slagschroefmachines

**IMPAKTOR**  
Diamond

De kwb Impaktor bithoudertechnologie zorgt door een optimale benutting van de materiaaleigenschappen en door optimaal aangepaste geometrieën (twee gekoppelde, na elkaar werkende torsiezones) voor een buitengewone levensduur, ook bij extreme omstandigheden.

De Impaktor houder met ringmagneet houdt bovendien ook lange en zware schroeven stevig vast. Bliksemsnel en betrouwbaar aanzetten van de schroef, vermijdt scheef aanzetten en vernielen van de schroef. Gebruik vooral bij handmatig machineschroefwerk. Geschikt voor bits met 1/4" C 6.3 aansluiting.



Een buitengewone levensduur door optimale benutting van de materiaaleigenschappen in combinatie met speciaal op extreme omstandigheden afgestemde geometrieën en door de bijzondere productiemethode. Bij de productie van de kwb Impaktor bitserie vindt een optimaal passende combinatie

plaats van geometrische vormgeving, hardheid, productiemethode en veredeling voor het betreffende aandrijfprofiel en dus voor de individuele schroeftoepassing.

De kwb Impaktor bithouder is bijzonder geschikt voor gebruik met normale impact-/slagschroevendraaiers.



De Impaktor bithouder dient voor het opvangen van extreme impulsieken en reageert door het TriTorsion-systeem individueel op de gebruikte aandrijfkracht van de impact-/slagschroevendraaier.



kwb Impaktor bits met Impaktor bithouder hebben naargelang de aandrijfkracht een tot 10 keer langere levensduur dan conventionele of torsiebits.

**TriTorsion**

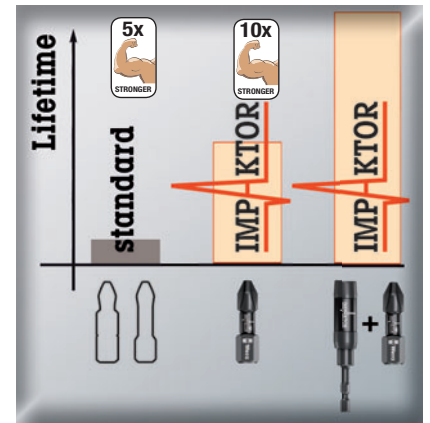

Levensduurvergelijking met conventionele bits

### Impaktor bithouder



Impaktor bithouder, 1/4"-zeskantschacht volgens ISO 1173, met permanente ringmagneet, veerring, snelwisselfunctie, eenhandsbediening, bitvrijgave door eenvoudig terugtrekken van de metalen huls, zeskantenschacht 1/4"-houder volgens ISO 1173, E 6.3, bijzonder geschikt voor gebruik met normaal verkrijgbare impact-/slagschroevendraaiers



Art.-nr.	Inhoud			EAN
100500	Impaktor bithouder		5	4 0093 11 005007

**Bithouder rvs-huls**



Bithouder, 1/4"-zeskandhouder volgens ISO 1173, met permanente magneet, veerring, zeschantschacht 1/4"-houder volgens ISO 1173, E 6.3.



Art.-nr.	Houder	Lengte	Schacht			EAN
100100	1/4" ○	75 mm	1/4" ● E 6.3			4 009311 001009
100800	1/4" ○	58 mm	1/4" ● E 6.3			4 009311 008008
100811	1/4" ○	58 mm	1/4" ● E 6.3			4 009311 008114

**Bithouder messinghuls**



Bithouder, 1/4"-zeskandhouder volgens ISO 1173, met permanente magneet, veerring, zeschantschacht 1/4"-houder volgens ISO 1173, E 6.3.



Art.-nr.	Houder	Lengte	Schacht			EAN
100120	1/4" ○	75 mm	1/4" ● E 6.3			4 009311 001207
100121	1/4" ○	75 mm	1/4" ● E 6.3			4 009311 001214

**Bithouder rvs-huls, SDS-plus-opnameschacht**



Bithouder, houder 1/4"-zeskant volgens ISO 1173, met permanente magneet, veerring en SDS-plus-opnameschacht.



Art.-nr.	Houder	Lengte	Schacht			EAN
100600	1/4" ○	75 mm	SDS Plus			4 009311 006004

## Snelwisselbithouder



Snelwisselbithouder, houder 1/4"-zeskant volgens ISO 1173, met permanente magneet, veerring, snelwisselfunctie, eenhandsbediening, bitvrijgave door eenvoudig terugtrekken van de metalen huls, zeskantschacht 1/4"-houder volgens ISO 1173, E 6.3.

Art.-nr.	Houder	Lengte	Schacht			EAN
100300	1/4" ○	51 mm	1/4" ● E 6.3			4 009311 003003



## Automatische snelwisselbithouder



Automatische snelwisselbithouder, one touch, houder 1/4"-zeskant volgens ISO 1173, met permanente magneet, veerring, snelwisselfunctie, eenhandsbediening, bitvrijgave door op de vrijgaveknop te drukken, zeskantschacht 1/4"-houder volgens ISO 1173, E 6.3.

Art.-nr.	Houder	Lengte	Schacht			EAN
100400	1/4" ○	65 mm	1/4" ● E 6.3			4 009311 004000



## Snelwisselbithouder, extra lang



Snelwisselbithouder, extra lang, houder 1/4"-zeskant volgens ISO 1173, met permanente magneet, veerring, snelwisselfunctie, eenhandsbediening, bitvrijgave door eenvoudig terugtrekken van de metalen huls, zeskantschacht 1/4"-houder volgens ISO 1173, E 6.3.

Art.-nr.	Houder	Lengte	Schacht			EAN
100715	1/4" ○	150 mm	1/4" ● E 6.3			4 009311 007155
100730	1/4" ○	300 mm	1/4" ● E 6.3			4 009311 007308



90° haaks bit- en boorhulpstuk



Met de slechts 32 mm brede, kogelgelagerde, 90° haakse kop kan ook op alle kleine en moeilijk toegankelijke plaatsen worden geschroefd of geboord. Snel en eenvoudig vervangen van de 1/4"-bits of boren met zeskant C6.3 of E6.3-houder. Met de geprofileerde kunststof greep heeft men een goede grip en kan men bij het schroeven of boren op moeilijk toegankelijke plaatsen veilig de benodigde kracht uitoefenen. Passend voor elke normale accuschroevendraaier of boormachine.

Art.-nr.	Houder	Lengte	Schacht			EAN
118400	1/4" ○	15,5 mm	1/4" ● E 6.3		1	4 009311 184009



Haakse bithouder



Haakse bithouder, 1/4"-houder volgens ISO 1173, kop met 90°-hoek, snel en gemakkelijk wisselen van 1/4"-bits of -boren, veilige geleiding bij het schroeven of het boren op moeilijk toegankelijke plekken, veilige krachtoverdracht, 1/4"-zeskantschacht, geschikt voor elke normaal verkrijgbare accuschroefmachine of boormachine.

Art.-nr.	Houder			EAN
118100	1/4" ○		6	4 009311 181008



## Bits DIAMANT-gecoat



Art.-nr.		Nominale maat			EAN
<b>⊕ Phillips / kruis DIN 8764, ZB-kaart</b>					
103601	25	Nr. 1		5	
103602	25	Nr. 2		5	
103603	25	Nr. 3		5	

Bits met DIAMANT gecoat, aandrijving 1/4"-zeskant volgens ISO 1173, C 6.3, de diamantcoating zorgt voor een hogere wrijvingsweerstand en vermindert de kans dat de bit uit de schroef losschiet waardoor minder druk moet worden uitgeoefend, voor moeiteloos werken.



Art.-nr.		Nominale maat			EAN
<b>⊕ Phillips / kruis DIN 8764, los</b>					
103611	25	Nr. 1		Z5	
103612	25	Nr. 2		Z5	
103613	25	Nr. 3		Z5	



Art.-nr.		Nominale maat			EAN
<b>⊕ Pozidriv DIN 8764, ZB-kaart</b>					
103701	25	Nr. 1		5	
103702	25	Nr. 2		5	
103703	25	Nr. 3		5	

























Art.-nr.		Nominale maat			EAN
<b>⊕ Pozidriv DIN 8764, los</b>					
103711	25	Nr. 1		Z5	
103712	25	Nr. 2		Z5	
103713	25	Nr. 3		Z5	



Bits DIAMANT-gecoat





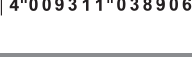

Art.-nr.		Nominale maat			EAN
<b>TORX® EN ISO 10664, ZB-kaart</b>					
103810	25	T 10		5	
103815	25	T 15		5	
103820	25	T 20		5	
103825	25	T 25		5	
103830	25	T 30		5	
103840	25	T 40		5	

Art.-nr.		Nominale maat			EAN
<b>TORX® EN ISO 10664, los</b>					
103860	25	T 10		Z10	
103865	25	T 15		Z10	
103875	25	T 25		Z10	
103880	25	T 30		Z10	
103890	25	T 40		Z10	

Handy bitbox DIAMANT, 7-delig



Handy bitbox DIAMANT gecoat, aandrijving 1/4"-zeskant volgens ISO 1173, C 6.3, de diamantcoating zorgt voor een hogere wrijvingsweerstand en vermindert de kans dat de bit uit de schroef losschiet waardoor minder druk moet worden uitgeoefend, bithouder met permanente magneet, veering, zeskantschacht, 1/4"-houder volgens ISO 1173, E 6.3, gepatenteerde bitbox, ook bruikbaar om handmatig te schroeven.

Art.-nr.	Inhoud			EAN
155300	7-delig ⊕ nr.1, 2, 3 / ⊕ nr. 1, 2, 3 / bithouder 1/4" C 6.3 / 1/4" E 6.3		6	





## Bits, TITAAN genitreed



Art.-nr.		Inhoud	Nominale maat			EAN
<b>⊕ Phillips / kruis DIN 8764, ZB-kaart</b>						
101501	25	1	Nr. 1		10	4 009311 015013
101502	25	1	Nr. 2		10	4 009311 015020
101503	25	1	Nr. 3		10	4 009311 015037

Bits TITAAN genitreed, aandrijving 1/4"-zeskant volgens ISO 1173, C 6.3, hoogwaardige oppervlakteafwerking voor een beperkte wrijving en een lange levensduur bij maximale continue belasting.

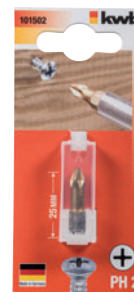

Art.-nr.		Nominale maat			EAN
<b>⊕ Phillips / kruis DIN 8764, los</b>					
101511	25	Nr. 1		Z10	4 009311 015112
101512	25	Nr. 2		Z10	4 009311 015129
101513	25	Nr. 3		Z10	4 009311 015136



Art.-nr.		Inhoud	Nominale maat			EAN
<b>⊕ Pozidriv DIN 8764, ZB-kaart</b>						
101601	25	1	Nr. 1		10	4 009311 016010
101602	25	1	Nr. 2		10	4 009311 016027
101603	25	1	Nr. 3		10	4 009311 016034



Art.-nr.		Inhoud	Nominale maat			EAN
<b>⊕ Pozidriv DIN 8764, professionele verpakking 10 st.</b>						
101662	25	10	Nr. 2		1	4 009311 016621



























Art.-nr.		Nominale maat			EAN
<b>⊕ Pozidriv DIN 8764, los</b>					
101611	25	Nr. 1		Z10	4 009311 016119
101612	25	Nr. 2		Z10	4 009311 016126
101613	25	Nr. 3		Z10	4 009311 016133



Bits, TITAAN genitreerd







Art.-nr.		Inhoud	Nominale maat			EAN	
<b>TORX® EN ISO 10664, ZB-kaart</b>							
101710		25	1	T 10		10	
101715		25	1	T 15		10	
101720		25	1	T 20		10	
101725		25	1	T 25		10	
101727		25	1	T 27		10	
101730		25	1	T 30		10	
101740		25	1	T 40		10	



Art.-nr.		Inhoud	Nominale maat			EAN	
<b>TORX® EN ISO 10664, professionele verpakking 10 st.</b>							
101793		25	10	T 20		1	
101794		25	10	T 25		1	













Art.-nr.		Nominale maat			EAN
<b>TORX® EN ISO 10664, los</b>					
101760		25	T 10	Z10	
101765		25	T 15	Z10	
101770		25	T 20	Z10	
101775		25	T 25	Z10	
101780		25	T 30	Z10	
101790		25	T 40	Z10	

Handy bitbox, TITAAN genitreerd, 7-delig



Handy bitbox TITAAN genitreerd, aandrijving 1/4"-zeskant volgens ISO 1173, C 6.3, hoogwaardige oppervlakteafwerking voor een beperkte wrijving en een lange levensduur bij maximale continue belasting, bithouder met permanente magneet, veering, zeskantschacht 1/4"-houder volgens ISO 1173, E 6.3, gepatenteerde bitbox, ook bruikbaar om handmatig te schroeven.



Art.-nr.	Inhoud			EAN	
154100	7-delig $\ominus$ 5, 7 mm / $\oplus$ nr. 1, 2 / $\oplus$ nr. 1, 2 / bithouder			6	
154200	T 10, 15, 20, 25, 30, 40 / bithouder			6	
154300	7-delig $\oplus$ nr. 1, 2, 3 / $\oplus$ nr. 1, 2, 3 / bithouder			6	

Handy bitbox, Tamper Torx, TITAAN genitreerd, 7-delig



Art.-nr.	Inhoud			EAN
154500	T 10, 15, 20, 25, 30, 40 / bithouder		6	4 009311 545008

Handy bitbox TITAAN genitreerd, aandrijving 1/4"-zeskant volgens ISO 1173, C 6.3, hoogwaardige oppervlakteafwerking voor een beperkte wrijving en een lange levensduur bij maximale continue belasting, bithouder met permanente magneet, veering, zeskantenschacht 1/4"-houder volgens ISO 1173, E 6.3, gepatenteerde bitbox, ook bruikbaar om handmatig te schroeven.



kwb-Info

## De gepatenteerde Handy bitbox van kwb waarmee men ook kan schroeven.

De kleine, handige Handy bitbox past in elke zak en biedt zo snel hulp als men onderweg schroefwerkzaamheden moet uitvoeren. Steek de bithouder met de gepaste bit op de bitbox en u kunt beginnen te schroeven.

De boxen zijn verkrijgbaar met diamantbits, titaanbits, Iso-Temp-bits, rvs-bits en standaard bits.



**Exclusief bij kwb**

**Bits, ISO-TEMP**



Bits ISO-TEMP, aandrijving 1/4"-zeskant volgens ISO 1173 C 6.3, hoge taaiheid, speciale bits voor moeilijke schroefwerkzaamheden, speciaal gehard, duidelijk beperkt breukgevaar, ACR-punt, de ribbels van de punt voorkomen dat de bits uit de schroef glijden waardoor minder druk moet worden uitgeoefend.



Art.-nr.		Inhoud	Nominale maat			EAN
<b>⊕ Phillips / kruis DIN 8764, ZB-kaart</b>						
104201	25	1	Nr. 1		10	4 009311 042019
104202	25	1	Nr. 2		10	4 009311 042026
104203	25	1	Nr. 3		10	4 009311 042033

Art.-nr.		Nominale maat			EAN
<b>⊕ Phillips / kruis DIN 8764, los</b>					
104211	25	Nr. 1		Z10	4 009311 042118
104212	25	Nr. 2		Z10	4 009311 042125

Art.-nr.		Inhoud	Nominale maat			EAN
<b>⊕ Pozidriv DIN 8764, ZB-kaart</b>						
104301	25	1	Nr. 1		10	4 009311 043016
104302	25	1	Nr. 2		10	4 009311 043023
104303	25	1	Nr. 3		10	4 009311 043030

Art.-nr.		Nominale maat			EAN
<b>⊕ Pozidriv DIN 8764, los</b>					
104312	25	Nr. 2		Z10	4 009311 043122
104313	25	Nr. 3		Z10	4 009311 043139

**Handy bitbox ISO-TEMP, 7-delig**



Art.-nr.	Inhoud			EAN
153100	7-delig $\ominus$ 5,6 mm / $\oplus$ nr. 1, 2 / $\oplus$ nr. 1, 2 / bithouder		6	4 009311 531001
153300	7-delig $\oplus$ nr. 1, 2, 3 / $\oplus$ nr. 1, 2, 3 / bithouder		6	4 009311 533005

Handy bitbox ISO-TEMP, aandrijving 1/4"-zeskant volgens ISO 1173 C 6.3, hoge taaiheid, speciale bits voor moeilijke schroefwerkzaamheden, speciaal gehard, duidelijk beperkt breukgevaar, ACR-punt, de ribbels van de punt voorkomen dat de bits uit de schroef glijden waardoor minder druk moet worden uitgeoefend, bithouder met permanente magneet, veerring, zeskantschacht, 1/4"-houder volgens ISO 1173, E 6.3, gepatenteerde bitbox, ook bruikbaar om handmatige te schroeven.



**kwb-Info**

**Praktische opbergbox voor alle afzonderlijke bits**

**Exclusief bij kwb**

Alle kwb-bits worden geleverd in een praktische opbergbox.

**En wat zo bijzonder is:**

alle opbergboxen kunnen met elkaar worden verbonden, zodat alle bits altijd bij de hand zijn en toch veilig opgeborgen zijn.

Elke bit is apart beschermd en kan niet meer verloren gaan in de gereedschapskist.



**Bits, RVS**



Bits RVS, aandrijving 1/4"-zeskant volgens ISO 1173, C 6.3, voor het vastschroeven van rvs-schroeven om roestpunten door afslijting te voorkomen, ideaal voor schroefverbindingen buiten, bijv. terrasvloeren, pergola's, zitbanken enz.

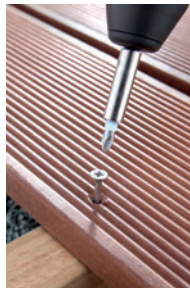

Art.-nr.		Nominale maat			EAN
<b>⊕ Pozidriv DIN 8764, ZB-kaart</b>					
104801	25	Nr. 1		5	4 009311 048011
104802	25	Nr. 2		5	4 009311 048028
104803	25	Nr. 3		5	4 009311 048035

Art.-nr.		Nominale maat			EAN
<b>⊕ TORX® EN ISO 10664, ZB-kaart</b>					
104915	25	T 15		5	4 009311 049155
104920	25	T 20		5	4 009311 049209
104925	25	T 25		5	4 009311 049254

**Handy bitbox RVS, 7-delig**



















Handy bitbox RVS, aandrijving 1/4"-zeskant volgens ISO 1173, C 6.3, voor het vastschroeven van rvs-schroeven om roestpunten door afslijting te voorkomen, ideaal voor schroefverbindingen buiten, bijv. terrasvloeren, pergola's, zitbanken enz., bithouder met permanente magneet, veerring, zeskantschacht 1/4"-houder volgens ISO 1173, E 6.3, gepatenteerde bitbox, ook bruikbaar om handmatig te schroeven.



Art.-nr.	Inhoud			EAN
156400	Magnetische bithouder / ⊕ nr. 1, 2 / ⊕ nr. 1, 2 / ⊕ T 20, T 25		6	4 009311 564009

## Bits STANDAARD



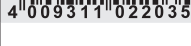







Art.-nr.		Inhoud	Nominale maat			EAN
<b>⊕ Phillips / kruis DIN 8764, ZB-kaart</b>						
101201	25	1	Nr. 1		10	
101202	25	1	Nr. 2		10	
101203	25	1	Nr. 3		10	
102201	25	3	Nr. 1		10	
102202	25	3	Nr. 2		10	
102203	25	3	Nr. 3		10	
106000	25	⊕ Phillips / kruis DIN 8764 nr. 1, 2, 3	Nr. 1, 2, 3		5	

Bits STANDAARD, industriële kwaliteit, aandrijving 1/4"-zeskant volgens ISO 1173, C 6.3, hoge taaiheid, voor alle standaard schroefwerkzaamheden.





















Art.-nr.		Inhoud	Nominale maat			EAN
<b>⊕ Phillips / kruis DIN 8764, professionele verpakking 10 st.</b>						
101262	25	10	Nr. 2		1	



Art.-nr.		Nominale maat			EAN
<b>⊕ Phillips / kruis DIN 8764, los</b>					
101211	25	Nr. 1		Z10	
101212	25	Nr. 2		Z10	
101213	25	Nr. 3		Z10	







Art.-nr.		Inhoud	Nominale maat			EAN
<b>⊕ Pozidriv DIN 8764, ZB-kaart</b>						
101301	25	1	Nr. 1		10	
101302	25	1	Nr. 2		10	
101303	25	1	Nr. 3		10	
101304	32	1	Nr. 4		10	
102301	25	3	Nr. 1		10	
102302	25	3	Nr. 2		10	
102303	25	3	Nr. 3		10	
106100	25	⊕ Pozidriv DIN 8764 nr. 1, 2, 3	Nr. 1, 2, 3		5	





Bits **STANDAARD**











Art.-nr.	 mm	Inhoud	Nominale maat			EAN
⊕ Pozidriv DIN 8764, professionele verpakking 10 st.						
101362	25	10	Nr. 2		1	4 009311 013620
101363	25	10	Nr. 3		1	4 009311 013637

















Art.-nr.	 mm	Nominale maat			EAN
⊕ Pozidriv DIN 8764, los					
101311	25	Nr. 1		Z10	4 009311 013118
101312	25	Nr. 2		Z10	4 009311 013125
101313	25	Nr. 3		Z10	4 009311 013132
101314	32	Nr. 4		Z10	4 009311 013149



Art.-nr.	 mm	Inhoud	Nominale maat			EAN
● inbus, ZB-kaart						
101002	25	1	2,5		5	4 009311 010025
101003	25	1	3		5	4 009311 010032
101004	25	1	4		5	4 009311 010049
101005	25	1	5		5	4 009311 010056
101006	25	1	6		5	4 009311 010063



Art.-nr.	 mm	Inhoud	Nominale maat			EAN
● TORX <sup>®</sup> EN ISO 10664, ZB-kaart						
101806	25	1	T 6		5	4 009311 018069
101807	25	1	T 7		5	4 009311 018076
101808	25	1	T 8		5	4 009311 018083
101809	25	1	T 9		5	4 009311 018090
101810	25	1	T 10		5	4 009311 018106
101815	25	1	T 15		5	4 009311 018151
101820	25	1	T 20		5	4 009311 018205
101825	25	1	T 25		5	4 009311 018250
101827	25	1	T 27		5	4 009311 018274
101830	25	1	T 30		5	4 009311 018304
101840	25	1	T 40		5	4 009311 018403











## Bits STANDAARD



Art.-nr.		Inhoud	Nominale maat			EAN
<b>TORX® EN ISO 10664, professionele verpakking 10 st.</b>						
101892	25	10	T 15		1	4 009311 018922
101893	25	10	T 20		1	4 009311 018939
101894	25	10	T 25		1	4 009311 018946



Art.-nr.		Nominale maat			EAN
<b>TORX® EN ISO 10664, los</b>					
101859	25	T 9		Z5	4 009311 018598
101860	25	T 10		Z5	4 009311 018601
101865	25	T 15		Z5	4 009311 018656
101870	25	T 20		Z5	4 009311 018700
101875	25	T 25		Z5	4 009311 018755
101880	25	T 30		Z5	4 009311 018809
101890	25	T 40		Z5	4 009311 018908



## Handy bitbox STANDAARD, 7-delig







Art.-nr.	Inhoud			EAN
152500	10, 15, 20, 25, 30, 40 / bithouder		6	4 009311 525000

Handy bitbox STANDAARD, aandrijving 1/4"-zeskant volgens ISO 1173, C 6.3, hoge taaiheid, voor alle standaard schroefwerkzaamheden, bithouder met permanente magneet, veerring, zesnantschacht 1/4"-houder volgens ISO 1173, E 6.3, gepatenteerde bitbox, ook bruikbaar om handmatig te schroeven.



## PROFESSIONELE Power bitbox STANDAARD, 31-delig



Art.-nr.	Inhoud			EAN
162200	⊖ 2 x Nr. 1, 4 x Nr. 2, ⊕ 2 x Nr. 1, 4 x Nr. 2, ⊕ 3 x 10, 15, 20, 5 x 25, 2 x 30, 40		1	4 009311 622006
162300	⊕ 3 x Nr. 1, 10 x Nr. 2, 2 x Nr. 3 / ⊕ 3 x Nr. 1, 10 x Nr. 2, 2 x Nr. 3		1	4 009311 623003

Power bitbox STANDAARD, industriële kwaliteit, aandrijving 1/4"-zeskant volgens ISO 1173, C 6.3, hoge taaiheid, voor alle standaard schroefwerkzaamheden, snelwisselbithouder, 1/4"-zeskanthouder volgens ISO 1173, met permanente magneet, veerring, snelwisselfunctie, zesnantschacht 1/4"-houder volgens ISO 1173, E 6.3, gepatenteerde bitbox.











**Bits STANDAARD**











Bits STANDAARD, industriële kwaliteit, aandrijving 1/4"-zeskant volgens ISO 1173, E 6.3, hoge taaiheid, voor alle standaard schroefwerkzaamheden.

















Art.-nr.		Inhoud	Nominale maat			EAN
<b>⊕ Phillips / kruis DIN 8764, ZB-kaart</b>						
102901		1	Nr. 1		5	4 0093 11 029010
102902		1	Nr. 2		5	4 0093 11 029027
102903		1	Nr. 3		5	4 0093 11 029034



Art.-nr.		Inhoud	Nominale maat			EAN
<b>⊕ Pozidriv DIN 8764, ZB-kaart</b>						
103001		1	Nr. 1		5	4 0093 11 030016
103002		1	Nr. 2		5	4 0093 11 030023
103003		1	Nr. 3		5	4 0093 11 030030



Art.-nr.		Inhoud	Nominale maat			EAN
<b>⊕ TORX<sup>®</sup> EN ISO 10664, ZB-kaart</b>						
103110		1	T 10		5	4 0093 11 031105
103115		1	T 15		5	4 0093 11 031150
103120		1	T 20		5	4 0093 11 031204
103125		1	T 25		5	4 0093 11 031259
103130		1	T 30		5	4 0093 11 031303
103140		1	T 40		5	4 0093 11 031402



Art.-nr.	Inhoud			EAN
<b>⊕ Pozidriv DIN 8764 + ⊕ Phillips / kruisgleuf DIN 8764, ZB-kaart</b>				
108602	Nr. 2 x nr. 2		5	4 0093 11 086020

## Dopsleutelset met adapter, 5-delig



Dopsleutelset, chroom-vanadium, hoogglanzend verchroomd, met STANDAARD adapter, opname 1/4"-vierkant, aandrijving 1/4"-zeskant volgens ISO 1173, E 6.3.

Art.-nr.	Inhoud			EAN
105100	● 7, 8, 10, 13 mm, adapter 50 mm		5	4 009311 051004



## Adapterset voor dopsleutels, 2-delig



Adapterset voor doppen, chroom-vanadium, STANDAARD, voor alle standaard dopsleutels met 1/4"-vierkanthouder.

Adapter 30 mm, 1/4"-vierkanthouder, aandrijving 1/4"-zeskant volgens ISO 1173, C 6.3.

Adapter 50 mm, 1/4"-vierkanthouder, aandrijving 1/4"-zeskant volgens ISO 1173, E 6.3.

Art.-nr.	Inhoud			EAN
105200	● 1/4" x ■ 1/4" 30 mm ● 1/4" x ■ 1/4" 50 mm		5	4 009311 052001



## Adapterset voor dopsleutels, 3-delig



Adapterset voor doppen, chroom-vanadium, hoogglanzend verchroomd, voor alle standaard dopsleutels met 1/4", 3/8", 1/2", aandrijving 1/4"-zeskant volgens ISO 1173, E 6.3.





Art.-nr.	Inhoud			EAN
105300	● 1/4" x ■ 1/4" / ● 1/4" x ■ 3/8" ● 1/4" x ■ 1/2"		6	4 009311 053008



**ECONOMY dubbelebitset 1/4", in houder, 6-delig**



Dubbelebitset, 65 mm, STANDAARD, industriële kwaliteit, aandrijving 1/4", hoge taaheid, voor alle standaard schroefwerkzaamheden.





Art.-nr.		Inhoud			EAN
110900	65	⊕ Kruis / Phillips x ⊖ Plat nr. 1 x 4, nr. 2 x 5, nr. 3 x 6 mm, ⊕ Pozidriv x ● 6-kant		10	 4 009311 109002



**ECONOMY bitset, 1/4", extra lange uitvoering, in houder, 6-delig**



Bitset, extra lange uitvoering, 75 mm, STANDAARD, industriële kwaliteit, aandrijving 1/4"-zeskant volgens ISO 1173, E 6.3, hoge taaheid, voor alle standaard schroefwerkzaamheden.





Art.-nr.		Inhoud			EAN
111100	75	⊕ Kruis Phillips nr. 1, 2, 3 ⊕ Pozidriv nr. 1, 2, 3		10	 4 009311 111005



**ECONOMY bitset, 1/4", extra lange uitvoering, in houder, 4-delig**



Bitset, extra lange uitvoering, 130 mm, STANDAARD, industriële kwaliteit, aandrijving 1/4"-zeskant volgens ISO 1173, E 6.3, hoge taaheid, voor alle standaard schroefwerkzaamheden.



Art.-nr.		Inhoud			EAN
111500	130	⊕ Kruis Phillips nr. 2 ⊕ Pozidriv nr. 1, 2, 3		10	 4 009311 115003

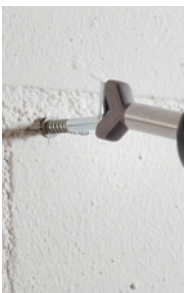

**Hakenschroever, 2-delig**



Hakenschroever STANDAARD, industriële kwaliteit, aandrijving 1/4"-zeskant, hoge taaheid, voor alle rechte of ronde haken en ogen tot 4 mm.

Art.-nr.	Houder	Lengte	Schacht			EAN
102000	1/4" ○	20 mm	1/4" ● C 6.3			 4 009311 020000

## Bits met dieptestop **STANDAARD**



Bits met dieptestop, STANDAARD, aandrijving 1/4"-zeskant volgens ISO 1173, C 6.3, hoge taaiheid voor het vastschroeven van lichte platen zoals bijv. gipsplaten, voorkomt onopzettelijk te ver doorschroeven.

Art.-nr.	Inhoud			EAN
104500	⊕ Phillips / kruis DIN 8764 nr. 2		2	4 009311 045003
104600	⊕ Pozidriv DIN 8764 nr. 2		2	4 009311 046000



## Bitset **STANDAARD, 9-delig**



Bitset STANDAARD, aandrijving 1/4"-zeskant volgens ISO 1173, C 6.3, hoge taaiheid, voor alle standaard schroefwerkzaamheden, bithouder met permanente magneet, veerring, zeskantschacht 1/4"-houder volgens ISO 1173, E 6.3, praktische box met laden.

Art.-nr.		Inhoud			EAN
113900	25, 50	9-delig ⊖ 4,5, 7 mm / ⊕ nr. 1, 2 / ⊕ nr. 1, 2 / ⊕ nr. 2 / ⊕ nr. 2 / bithouder 1/4" C 6.3 / 1/4" E 6.3		10	4 009311 339009



## Precisiebit- en -doppenset **STANDAARD, 40-delig**



Precisiebit- en -doppenset STANDAARD, aandrijving bits 4mm-zeskant, met gekleurde markeerringen, inclusief microbits voor werkzaamheden aan brillen, mobiele telefoons, camera's, MP3-spelers, notebooks, afstandsbedieningen, doppen met kleurmarkeringen, flexibel verlengstuk, uittrekbare handschroevendraaier, houder 4mm-zeskant, in praktische opbergdoos, 10 sets in toonbankdisplay.

Art.-nr.	Inhoud			EAN
115700	1 bitschroevendraaier, 1 flexibel verlengstuk, doppen 3, 3,5, 4, 4,5, 5, 5,5, 6, 7 mm, 1 adapter 4 mm, torx 4, 5, 6, 7, 8, 9, 10, 15, 20 mm, zeskant 0,7, 0,9, 1,3, 1,5, 2,0, 2,5, 3,0, 4,0 mm, gleuf 1,5, 2,0, 2,5, 3,0, 3,5, 4,0 mm, PH000, PH00, PH0, PH1, PZ0, PZ1		10	4 009311 157008









**Power-Box STANDAARD, 67-delig**







Power-Box STANDAARD, bits aandrijving 1/4"-zeskant volgens ISO 1173, C 6.3 en E 6.3, snelwisselhouder met permanente magneet, 1/4"-zeskantschacht volgens ISO 1173, E 6.3, met gekleurde markeerringen, steen-, metaal- en houtboren met 1/4"-zeskantschacht E 6.3, CV-doppen met Gear-profiel, 2 lange bithouders, in stevige metalen koffer.

Art.-nr.	Inhoud			EAN
106300	Zie onderstaand overzicht		4	

**35 Bits, 25 MM lang, schacht 1/4" C6.3**

-  2, 4, 6 MM
-  PH Nr. 0, 1, 1, 2, 2, 3
-  PZ Nr. 1, 1, 2, 2, 3
-  Ⓢ T15, T20, T25
-  T8, T9, T10, T15, T20, T25, T30, T40
-  2, 2.5, 3, 4, 5, 6 MM
-  3, 4, 5, 6 MM

**9 Langbits, 70 MM lang, schacht 1/4" E6.3**

-  3 MM
-  PH Nr. 2
-  PZ Nr. 2
-  Ⓢ T20, T25
-  4, 6, 8, 10 MM

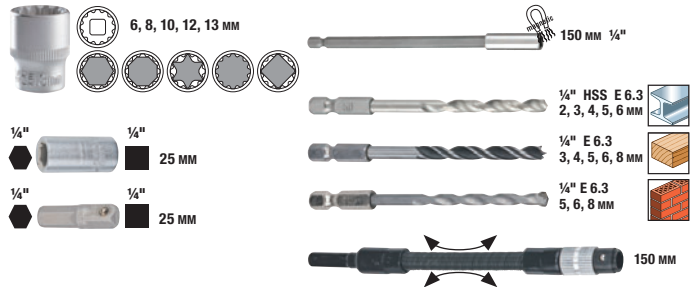





**Power-Bit-Box STANDAARD, 92-delig**







Power-Box STANDAARD, bits aandrijving 1/4"-zeskant volgens ISO 1173, C 6.3 en E 6.3, inclusief bits met bijzondere kopvormen, voor gebruik op elektronische onderdelen, behuizingen enz., bithouder met permanente magneet, 1/4"-zeskantschacht volgens ISO 1173, E 6.3, CV-doppen Super Lock, lange bithouder, ratelhandgreep met 1/4"-zeskant-houder volgens ISO 1173, in stevige metalen koffer

Art.-nr.	Inhoud			EAN
106800	Zie onderstaand overzicht		6	





**63 x - 25 MM -**

-  2, 4, 6.5 MM
-  Nr. 0, 1, 1, 2, 2, 3
-  Nr. 1, 1, 2, 2, 3
-  T10, T15, T20, T25, T30, T40
-  8, 9, 10, 15, 20, 25, 27, 30, 40





-  0, 1, 2, 3
-  4, 6, 8, 10
-  5, 6, 8
-  2, 2.5, 3, 4, 5, 6, 8
-  5/64", 3/32", 7/64", 1/8", 9/64", 5/32"



**17 x - 70 MM -**

-  3 MM
-  10, 15, 20, 25, 30, 40
-  1, 2, 3, 4
-  4, 6, 8, 10

**6 X 4, 4.5, 5, 5.5, 6, 8 MM**

-  1 X 60 MM
-  1 X 150 MM
-  1 X 25 MM
-  1 X 50 MM

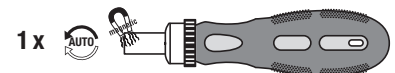

# Bitsets

## Bitset STANDAARD, 31-delig



Bitbox STANDAARD, bits aandrijving 1/4"-zeskant volgens ISO 1173, C 6.3, snelwisselhouder met permanente magneet, 1/4"-zeskanthouder volgens ISO 1173, 1/4"-zeskantschacht volgens ISO 1173, E 6.3, met gekleurde markeerringen om de kopvormen te onderscheiden, voor alle standaard schroefwerkzaamheden, in handige, plaatsbesparende vouwbox, eenvoudig uit te nemen bits, dankzij onafhankelijk van elkaar uitklapbare bitlijsten.

Art.-nr.	Inhoud			EAN
107100			8	

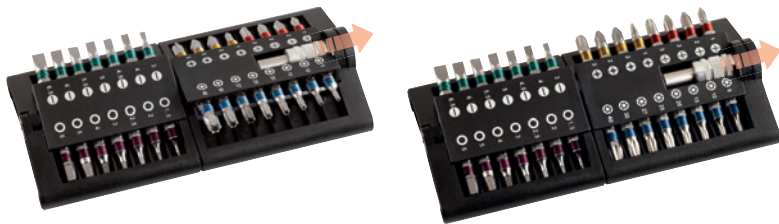

## Precisiemicrobitset STANDAARD, 11-delig



Precisiemicrobitset STANDAARD, bits aandrijving 1/4"-zeskant volgens ISO 1173, C 6.3, houder met permanente magneet 1/4"-zeskanthouder volgens ISO 1173, 1/4"-zeskantschacht volgens ISO 1173, E 6.3, handgreep met snelwisselhouder 1/4"-zeskant volgens ISO 1173, voor werkzaamheden aan brillen, mobiele telefoons, camera's, MP3-spelers, notebooks, en afstandsbedieningen, in praktische zelfopenende opbergdoos.

Art.-nr.	Inhoud			EAN
117700	Zie onderstaand overzicht		10	



**Bitbox STANDAARD, 32-delig**



Bitbox STANDAARD, 32-delig, bits: aandrijving 1/4"-zeskant volgens ISO 1173, C 6.3, industriële kwaliteit, met gekleurde markeerringen om de kopvormen te onderscheiden, snelwisselbithouder aandrijving 1/4"-zeskant volgens ISO 1173, E 6.3, box met praktische riemclip, 12 stuks in toonbankdisplay

Art.-nr.	Inhoud			EAN
118800	Zie onderstaand overzicht		12	4 0 093 11 188007

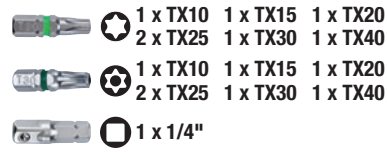
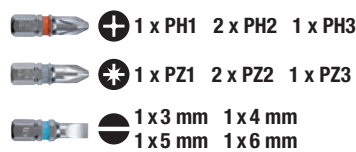

**Bitbox STANDAARD, 17-delig, bits en doppen**



Bitbox STANDAARD, 17-delig, bits en doppen, bits: aandrijving 1/4"-zeskant volgens ISO 1173, C 6.3, industriële kwaliteit, met gekleurde markeerringen om de kopvormen te onderscheiden, CV-doppen, met Gear-profiel, voor alle gangbare schroefkopvormen, omschakelbare rvs-ratel met 1/4"-zeskant volgens ISO 1173, box met praktische riemclip, 12 stuks in toonbankdisplay.

Art.-nr.	Inhoud			EAN
118900	Zie onderstaand overzicht		12	4 0 093 11 189004

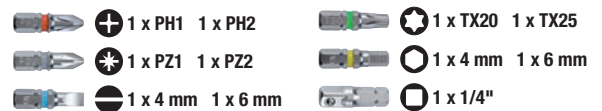

**Bitbox STANDAARD, 17-delig, bits en microbits**



Bitbox STANDAARD, 35-delig, bits: aandrijving 1/4"-zeskant volgens ISO 1173, C 6.3, microbits: aandrijving 4mm-zeskant, industriële kwaliteit, met gekleurde markeerringen om de kopvormen te onderscheiden, bithouder aandrijving 1/4"-zeskant volgens ISO 1173, E 6.3, micromagneethouder, houder 4 mm, 2C-handgreep, Box met praktische riemclip, 12 stuks in toonbankdisplay.

Art.-nr.	Inhoud			EAN
119000	Zie onderstaand overzicht		12	4 0 093 11 190000

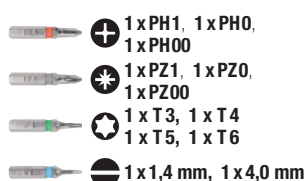
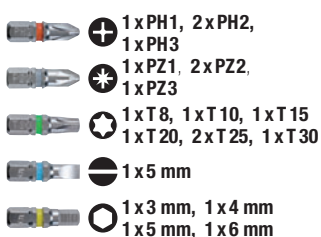



# Bitsets



## POWER BOX, 25-delig







In stevige kunststof koffer met veilige schuifsluiting. De optimale aanvulling voor alle accu-schroevendraaiers, accuboormachines en boormachines met snoer. Alle hout-, metaal- en steenboren, lange en korte bits in de gangbare maten voor snel gebruik in de machine. Snelle wisseling van boor of bit met de bijgeleverde bit- of snelwisselbithouder. Alle bits en bithouders van hoogwaardig chroom-vanadiumstaal.



Art.-nr.	Inhoud			EAN
109025	Zie onderstaand overzicht		20	

**1/4" 9 X 25 MM C 6.3**  
 ⊕ 1, 2, 3  
 ⊖ 4, 5, 6  
 ⊕ 1, 2, 3

**1/4" 3 X 50 MM E 6.3**  
 ⊕ 2  
 ⊖ 6  
 ⊕ 2

**HSS**  
**5x**  
 2, 3, 4, 5, 6 MM  

**HM (HW) TCT**  
**3x**  
 4, 5, 6 MM  

**CV**  
**3x**  
 4, 5, 6 MM  





 1x  1x





## POWER BOX, 44-delig







In stevige kunststof koffer met veilige schuifsluiting. De optimale aanvulling voor alle accu-schroevendraaiers, accuboormachines en boormachines met snoer. Alle hout-, metaal- en steenboren, lange- en korte bits in de gangbare maten voor snel gebruik in de machine. Snelle wisseling van boor of bit met de bijgeleverde bit- of snelwisselbithouder. Alle bits en bithouders van hoogwaardig chroom-vanadiumstaal.



Art.-nr.	Inhoud			EAN
109044	Zie onderstaand overzicht		20	

**1/4" 16 X 25 MM C 6.3**  
 ⊕ 1, 2, 3  
 ⊖ 4, 5, 6  
 ⊕ T10, T15, T20, T25, T27, T30, T40  
 ⊕ 1, 2, 3

**1/4" 6 X 50 MM E 6.3**  
 ⊕ 1, 2  
 ⊖ 4, 6  
 ⊕ 1, 2

**HSS**  
**11x**  
 1, 1.5, 2, 2.5, 3, 3.5, 4, 4.5, 5, 5.5, 6 MM  

**HM (HW) TCT**  
**4x**  
 4, 5, 6, 8 MM  

**CV**  
**5x**  
 3, 4, 5, 6, 8 MM  

 1x  1x

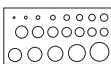
 1x

**POWER BOX, 75-delig**



In stevige kunststof koffer met veilige aluminium sluiting en geïntegreerde draaggreep. De optimale aanvulling voor alle accuschroevendraaiers, accuboormachines en boormachines met snoer. Talrijke hout-, metaal- en steenboren, zeskantdoppen, een assortiment lange- en korte bits in de gangbare maten voor snel gebruik in de machine. Snelle wisseling van boor of bit met de bijgeleverde bithouder. Incl. 2 vlakfreesboren voor het boren van doorgangen met laag toerental in zacht hout. Alle bits en bithouders van hoogwaardig chroom-vanadiumstaal.

Art.-nr.	Inhoud			EAN
109575	Zie onderstaand overzicht		10	4 0 09 3 11 09575 1

- 1/4"**  
**32 X 25 MM C 6.3**  
 ⊕ 0, 1, 2, 2, 2, 3  
 ⊖ 3, 4, 5, 5, 6, 6, 7  
 ● T10, T15, T20, T25, T27, T30, T40  
 ⊕ 0, 1, 2, 2, 2, 3  
 ● 2, 2.5, 3, 4, 5, 6

- 1/4"** **12 X 50 MM E 6.3**  
 ⊕ 1, 2, 2, 3  
 ⊖ 4, 5, 6, 6  
 ⊕ 1, 2, 2, 3  
 1/4" 1x  
 1/4" **6X** 4, 5, 6, 7, 8, 10 MM

**HSS**

- 11x**  
 1, 1.5, 2, 2.5, 3, 3.5, 4, 4.5, 5, 5.5, 6 MM

**HM (HW) TCT**

- 4x**  
 4, 5, 6, 8 MM

**CV**

- 5x**  
 3, 4, 5, 6, 8 MM

- 2x E 6.3**  
 16, 22

- 1x E 6.3**

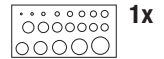

**Bit-Box STANDARD, 100-delig**



In stevige kunststof koffer met veilige aluminium sluiting en geïntegreerde draaggreep. De optimale aanvulling voor alle accuschroevendraaiers, accuboormachines en boormachines met snoer. Talrijke hout-, metaal- en steenboren, zeskantdoppen, gatenzagen, een assortiment lange en korte bits in de gangbare maten voor snel gebruik in de machine. Snelle wisseling van boor of bit met de bijgeleverde bithouder. Incl. 3 vlakfreesboren voor het boren van doorgangen met laag toerental in zacht hout en 4 gatenzagen voor het boren in houten en lichte wanden. Alle bits en bithouders van hoogwaardig chroom-vanadiumstaal.

Art.-nr.	Inhoud			EAN
109001	Zie onderstaand overzicht		10	4 0 09 3 11 09001 0

- 1/4"**  
**40 X 25 MM C 6.3**  
 ⊕ 0, 0, 1, 1, 2, 2, 2, 3, 3  
 ⊖ 3, 4, 4, 5, 5, 6, 6, 7  
 ● T10, T15, T20, T25, T27, T30, T40  
 ⊕ 0, 0, 1, 1, 2, 2, 2, 3, 3,  
 ● 2, 2.5, 3, 3.5, 4, 5, 6

- 1/4"** **12 X 50 MM E 6.3**  
 ⊕ 1, 2, 2, 3  
 ⊖ 4, 5, 6, 6  
 ⊕ 1, 2, 2, 3

**HSS**

- 14x**  
 1, 1.5, 2, 2.5, 3, 3.5, 4, 4.5, 5, 5.5, 6, 7, 8, 10 MM

**HM (HW) TCT**

- 5x**  
 4, 5, 6, 8, 10 MM

**CV**

- 5x**  
 3, 4, 5, 6, 8 MM

- 3x E 6.3**  
 16, 22, 25

- 1x E 6.3**

- 1/4" **8X** 4, 5, 6, 7, 8, 9, 10, 13 MM  
 1/4" 1x  
**3X** 6, 8, 10  
 1x

- 1x  
 1x  
**4X** 32, 38, 44, 54 MM

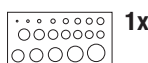



# BOORMACHINE- TOEBEHOREN

Boorhouders  
Raspen, vormfrezen  
Verzinkboren, plaatboren  
Slijpstiften  
Boorstandaarden  
Pompen  
Mengers

## Boormachinetoebehoren



### De voordelen van de boormachinetoebehoren

- Reserveboorhouders en boorhoudersleutels voor talrijke boormachines en accuboormachines
- Frezen, raspen, verzinkboren, trappenboren en plaatboren voor hout- en metaalbewerking
- Hulpstukken, boorstandaarden, buigzame assen, pompen en mixers voor gebruik met de normaal verkrijgbare standaard en accuboormachines

## Programma overzicht boormachinetoebehoren



### Boorhouders

★★★★★

Tandkrans- en snelspanboorhouders met de belangrijkste klemkransen en houders voor normale boormachines.

Pagina 102 - 104

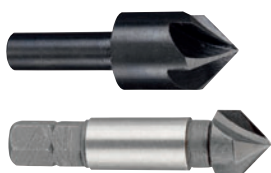

### Verzinkboren

★★★★★

Verzinkboren voor hout- en metaalbewerking. Verkrijgbaar in verschillende uitvoeringen.

Pagina 110 - 111

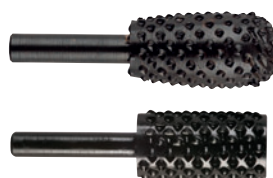

### Raspen en vormfrezen

★★★★★

Raspen en vormfrezen voor hout- en metaalbewerking. Verkrijgbaar in verschillende vormen.

Pagina 105 - 109



### Trappenboren en plaatboren

★★★★★

Trappenboren en plaatboren voor metaalbewerking. Verkrijgbaar in verschillende uitvoeringen.

Pagina 112 - 113

**kwb-info**

## Een kwestie van veiligheid



Ons oog is een van onze belangrijkste zintuigen en moet dus bij alle werkzaamheden worden beschermd. Daarom heeft kwb voor alle gangbare binnen- en buitentoepassingen, zoals boren, frezen, slijpen en lassen, een hoogwaardig, ook voor bril dragers geschikt assortiment veiligheidsbrillen samengesteld.

Alle informatie hierover vindt u in onze kwb-folder voor arbeidsveiligheid of op het Internet op **www.kwb.eu**.



### Hulpstukken

★★★★★

Hulpstukken voor standaard en accuboormachines.

Pagina 114



### Slijpstiften

★★★★★

Slijpstiften voor metaalbewerking. Verkrijgbaar in verschillende uitvoeringen.

Pagina 115 - 117



### Pompen

★★★★★

Voorzetspompen voor normale boormachines. Voor het over- en wegpompen van vloeistoffen.

Pagina 118 - 119



### Verf- en mortelmengers

★★★★★

Voor het mengen van dispersie- en muurverf, mortel, cementmortel, ondervloermortel en beton, voor gebruik in normale boormachines.

Pagina 120 - 121



Tandkransboorhouder



Tandkransboorhouder, volgens DIN 6349 L, slagboorvast, met S2-sleutel, binnenschroefdraad (vorm B), doorboord om de contraschroef als linksdraaibeveiliging te gebruiken, voor standaard en rechts of links draaiende boormachines.

Art.-nr.	Houder	Sleutelnr.	Sleuteltype	Spanbereik			EAN
291379	1/2" x 20	2858	S2	1.5 - 13 mm		2	4 009312 913790



Snelspanboorhouder



Snelspanboorhouder, zware uitvoering, met spankrachtbeveiliging, met hardmetaal versterkte spanklauwen, slagboorvast, binnenschroefdraad (vorm B), doorboord om de contraschroef als linksdraaibeveiliging te gebruiken, voor standaard en rechts of links draaiende boormachines, laat toe om gereedschappen snel te verwisselen.

Art.-nr.	Houder	Spanbereik			EAN
297872	1/2" x 20	1.5 - 13 mm		2	4 009312 978720



Snelspanboorhouder



Snelspanboorhouder, lichte uitvoering, met spankrachtbeveiliging, slagboorvast, binnenschroefdraad (vorm B), doorboord om de contraschroef als linksdraaibeveiliging te gebruiken, voor accuboormachines en -schroevendraaiers en lichte standaard en rechts of links draaiende boormachines, laat toe om gereedschappen snel te verwisselen.

Art.-nr.	Houder	Spanbereik			EAN
297472	1/2" x 20	1.5 - 13 mm		2	4 009312 974722



## Snelspanboorhouder



Snelspanboorhouder, lichte uitvoering, binnenschroefdraad (vorm B), doorboord om de contraschroef als linksdraaibeveiliging te gebruiken, voor accuboormachines en -schroevendraaiers en lichte standaard en rechts of links draaiende boormachines, laat toe om gereedschappen snel te verwisselen.

Art.-nr.	Houder	Spanbereik			EAN
298472	1/2" x 20	1.5 - 13 mm		2	4 009312 984721



## Tandkransboorhouder



Tandkransboorhouder, volgens DIN 6349 L, met sleutel S14 KG, 1/4"-zeskantschacht volgens ISO 1173, E 6.3, voor accu- en elektrische schroevendraaiers met 1/4"-zeskanthouder.



Art.-nr.	Houder	Spanbereik			EAN
292600	○ 1/4" E 6.3	0.5 - 6.5 mm		1	4 009312 926004



## Snelspanboorhouder



Snelspanboorhouder, volgens DIN 6349 L, 1/4"-zeskantschacht volgens ISO 1173, E 6.3, voor accu- en elektrische schroevendraaiers met 1/4"-zeskanthouder.

Art.-nr.	Houder	Spanbereik			EAN
292500	○ 1/4" E 6.3	0,5 - 6,5 mm		2	4 009312 925007



**Opnameschacht SDS-plus voor boorhouders**



Opnameschacht SDS-plus voor boorhouders, met M6-contraschroef voor linksdraaibeviliging, voor gebruik met gangbare boorhouders, op rechts en links draaiende boorhamers met slagstopinstelling.

Art.-nr.	Houder	voor			EAN
299900	1/2" x 20	291379, 297472, 297872, 298472		5	4 009312 999008



**Sleutel voor tandkransboorhouders**



Boorhoudersleutel, DIN-vertanding voor alle normaal verkrijgbare tandkransboorhouders van AEG, BOSCH, METABO enz.

Art.-nr.	voor	Sleuteltype			EAN
<b>ZB-kaart</b>					
285820	2913	S2		10	4 009312 858206
285920	2913	S2, lang		10	4 009312 859203

**Sleutel voor tandkransboorhouders, JACOBS-vertanding**



Boorhoudersleutel, JACOBS-vertanding, voor Black & Decker en Makita.

Art.-nr.	voor	Sleuteltype			EAN
283620	2810, 2926	S14 KG		10	4 009312 836204
273820	2813	S8 K30		10	4 009312 738201

**360° haaks boorkop-hulpstuk**



Compact, 360° verdraaibaar haaks boorkophulpstuk met 10mm-snelspanboorhouder. Door het kogelgewricht te verdraaien, kan de boorhouder in een cirkel van 360° snel in elke gewenste positie worden ingesteld. Hierdoor is de haakse boorkop zowel voor links- als voor rechtshandigen geschikt. Met een draai aan de handgreep wordt de boorkop vergrendeld. Met de rubberen antislipgreep heeft men een goede grip en kan men bij het boren op moeilijke plaatsen veilig de benodigde boorkracht uitoefenen. Om veiligheidsredenen bedraagt de max. boorlengte 190 mm (3/4"). De binnenin liggende conische aandrijving maakt ook werkzaamheden met hogere standtijden mogelijk. Daarom is de haakse boorkop ook geschikt voor serieboorwerk in de binnenafbouw of op bouwplaatsen. Met de zeskantschacht past de haakse boorkop in elke normale accuschroevendraaier of boormachine. De kop is niet geschikt voor het gebruik van gatenzagen of lange boren zoals bekistings-, doorvoer- of slangschroefboren.

Art.-nr.	Inhoud			EAN
298600	360° haaks boorkop-hulpstuk		1	4 009312 986008







## Boormachinetoebehoren

### Holle raspfrezen



Holle raspfrezen, WS, rechte vertanding, om te raspen, te boren, slobgaten, sleuven en profielen te frezen of pennen te snijden, voor houtbewerking.



Art.-nr.	Ø buiten	Ø binnen	T mm			EAN
705015	15 mm	10 mm	6		6	4 009317 050155
705020	20 mm	15 mm	6		6	4 009317 050209
705025	25 mm	20 mm	6		6	4 009317 050254



### Professionele raspen, houtbewerking



Profielraspen, WS, voor het raspen, het maken van profielen en het voorbereiden van uitsparingen, voor houtbewerking.



Art.-nr.	Vorm	Kop-Ø x hoogte	T mm			EAN
494300	Peer	16 x 30 mm	6		6	4 009314 943009



### Professionele raspen, houtbewerking



Profielraspen, WS, voor het raspen, het maken van profielen en het voorbereiden van uitsparingen, voor houtbewerking.

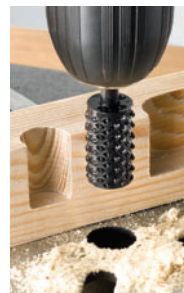

Art.-nr.	Vorm	Kop-Ø x hoogte	T mm			EAN
494500	Cilindrisch	16 x 30 mm	6		6	4 009314 945003



### Professionele raspen, houtbewerking



Profielraspen, WS, voor het raspen, het maken van profielen en het voorbereiden van uitsparingen, voor houtbewerking.

Art.-nr.	Vorm	Kop-Ø x hoogte	T mm			EAN
494600	Cilindrisch rond	13 x 35 mm	6		6	4 009314 946000



Professionele raspen, houtbewerking



Profielraspen, WS, voor het raspen, het maken van profielen en het voorbereiden van uitsparingen, voor houtbewerking.

Art.-nr.	Vorm	Kop-Ø x hoogte	mm			EAN
494700	Conisch	15 x 35 mm	6		6	4 009314 947007

Professionele raspen, houtbewerking



Profielraspen, WS, voor het raspen, het maken van profielen en het voorbereiden van uitsparingen, voor houtbewerking.

Art.-nr.	Vorm	Kop-Ø x hoogte	mm			EAN
494800	Kogel	16 mm	6		6	4 009314 948004

Professionele raspen, non-ferrometaalbewerking



Profielraspen, WS, voor het raspen, het maken van profielen en het voorbereiden van uitsparingen, voor non-ferrometaalbewerking.

Art.-nr.	Vorm	Kop-Ø x hoogte	mm			EAN
494900	Cilindrisch	16 x 30 mm	6		6	4 009314 949008

Professionele raspen, non-ferrometaalbewerking

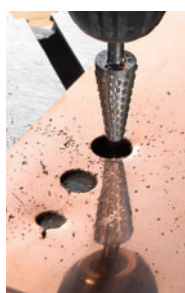

Profielraspen, WS, voor het raspen, het maken van profielen en het voorbereiden van uitsparingen, voor non-ferrometaalbewerking.

Art.-nr.	Vorm	Kop-Ø x hoogte	mm			EAN
495000	Conisch	15 x 35 mm	6		6	4 009314 950007

## Boormachinetoebehoren

### Profielraspenset, 6-delig



Profielraspen, WS, voor het raspen, het maken van profielen en het voorbereiden van uitsparingen, voor hout- en non-ferrometaalbewerking.

Art.-nr.	Vorm	Inhoud	mm			EAN
495500	Cilindrisch, cilindrisch rond, conisch, kogel/cilindrisch, conisch	4 x hout, 2 x non-ferrometaal	6		6	4 009314 955002



### Vormfrees



Vormfrees, HSS, om te frezen, profielen te maken en bij te werken in metaalbewerking.

Art.-nr.	Vorm	Kop-Ø x hoogte	mm			EAN
700140	Cilindrisch rond	13 x 32 mm	6		6	4 009317 001409



### Vormfrees



Vormfrees, HSS, om te frezen, profielen te maken en bij te werken in metaalbewerking.

Art.-nr.	Vorm	Kop-Ø x hoogte	mm			EAN
700340	Kegel rond	12 x 31 mm	6		6	4 009319 003403



### Vormfrees



Vormfrees, HSS, om te frezen, profielen te maken en bij te werken in metaalbewerking.

Art.-nr.	Vorm	Kop-Ø x hoogte	mm			EAN
700540	Kogel	12 x 12 mm	6		6	4 009317 005407



Vormfrees

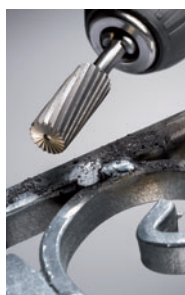

Vormfrees, HSS, om te frezen, profielen te maken en bij te werken in metaalbewerking.

Art.-nr.	Vorm	Kop-Ø x hoogte	⌀ mm			EAN
700740	Cilindrisch	13 x 30 mm	6		6	4 009317 007401

Vormfrees



Vormfrees, HSS, om te frezen, profielen te maken en bij te werken in metaalbewerking.

Art.-nr.	Vorm	Kop-Ø x hoogte	⌀ mm			EAN
700840	Kegel spits	13 x 30 mm	6		6	4 009317 008408

Houtfreesen



Houtfrees, WS, om te frezen en te profileren, voor de houtbewerking.

Art.-nr.	Vorm	Kop-Ø x hoogte	⌀ mm			EAN
557100	Sponning	25 x 20 mm	8		6	4 009315 571003

Houtfreesen



Houtfrees, WS, om te frezen en te profileren, voor de houtbewerking.

Art.-nr.	Vorm	Kop-Ø x hoogte	⌀ mm			EAN
557800	Schijfgleuf	2,5 x 35 mm	8		6	4 009315 578002

Houtfreesen



Houtfrees, WS, om te frezen en te profileren, voor de houtbewerking.

Art.-nr.	Vorm	Kop-Ø x hoogte	⌀ mm			EAN
557900	Schijfgleuf	5,0 x 35 mm	8		6	4 009315 579009

## Boormachinetoebehoren

### Sleufzagen



Sleufzaag, voor diepe, smalle sleuven, bruikbaar met de vrije hand of bevestigd in de kwb-boorstandaard, voor houtbewerking.

Art.-nr.	∅ mm	mm	mm			EAN
557000	50	8	0,8 mm		6	4 009315 570006



### Miniboormachinetoebehorensset, 105-delig



Miniboormachinetoebehorensset, geschikt voor alle miniboormachinesystemen en voor gebruik met de flexibele as, opnameschacht 3 mm, om te schuren, te frezen, te borstelen en te polijsten, voor hout- en metaalbewerking.

Art.-nr.	Inhoud			EAN
510900	Opspandoornen, polijstschijven, schuurschijven, doorslijpschijven, borstels, polijstpasta, slijpstiften, schuurrollen, wetsteen, vormfreen		10	4 009315 109008



### kwb-Info

## Een kwestie van veiligheid

Veiligheidshandschoenen dienen te worden gedragen bij alle toepassingen waarbij handletsels kunnen optreden, bijv. in de bouw, bij voorwerpen met scherpe randen enz. Bij alle werkzaamheden zijn grip en optimaal draagcomfort basisvoorwaarden voor de juiste veiligheidshandschoenen.

Alle informatie hierover vindt u in onze kwb-folder voor arbeidsveiligheid of op het internet op [www.kwb.eu](http://www.kwb.eu)



**Verzinkboor WS**



Verzinkboren, WS, 90°, 5-snijder, voor het verzinken en het perfect laten aansluiten van schroeven met verzonken kop, voor hout- en non-ferrometaalbewerking.

Art.-nr.	Ø mm	ℓ mm			EAN
704210	8	8		6	4 009317 042105
704310	12	8		6	4 009317 043102
704410	16	8		6	4 009317 044109
704510	20	8		6	4 009317 045106

**Verzinkborensset WS, 3-delig**



Verzinkborensset, WS, 90°, eensnijder, voor het verzinken en het perfect laten aansluiten van schroeven met verzonken kop, voor houtbewerking.

Art.-nr.	Ø mm	ℓ mm			EAN
511100	8, 12, 16	6, 8		6	4 009315 111001

**Verzinkboor WS, 1/4" zeskant C 6.3**



Verzinkboren, WS, 90°, 7-snijder, opnameschacht 1/4"-zeskant, voor accuschroevendraaiers en bithouders, voor het verzinken en perfect laten aansluiten van schroeven met verzonken kop, voor hout- en non-ferrometaalbewerking.

Art.-nr.	Ø mm	ℓ mm			EAN
704610	10	1/4"		6	4 009317 046103
704710	13	1/4"		6	4 009317 047100
704810	16	1/4"		6	4 009317 048107



**Verzinkboor HSS**

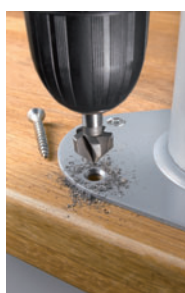

Verzinkboren, HSS, 90°, 5-snijder, voor het verzinken en het perfect laten aansluiten van schroeven met verzonken kop, voor metaalbewerking.

Art.-nr.	Ø mm	ℓ mm			EAN
704340	12	8		6	4 009317 043409
704440	16	8		6	4 009317 044406
704540	20	8		6	4 009317 045403

## Boormachinetoebehoren

### Verzinkboor HSS, 1/4" zeskant C 6.3



Verzinkboren, HSS, 90°, 3-snijder, opnameschacht 1/4"-zeskant, voor accuschroevendraaiers en bithouders, voor het verzinken en perfect laten aansluiten van schroeven met verzonken kop, voor metaalbewerking.

Art.-nr.	Kopdiameter	mm			EAN
704640	10 mm	● 1/4		6	4 009317 046400
704740	12 mm	● 1/4		6	4 009317 047407
704840	16 mm	● 1/4		6	4 009317 048404

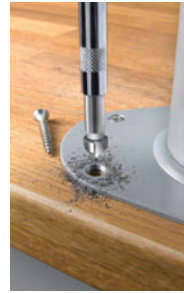

### Opsteekverzinkerset WS, 3-delig



Opsteekverzinkerset, WS, 90°, 5-snijder, als opsteekstuk voor HSS- en houtspiraalboren, om in één stap te boren en te verzinken, voor het verzinken en het perfect laten aansluiten van schroeven met verzonken kop, voor houtbewerking.

Art.-nr.	voor	Kop-Ø x hoogte			EAN
513050	Boren 4, 5, 6 mm	12 x 19 mm		5	4 009315 130507



## kwb-Info

### Een kwestie van veiligheid

Er zijn veel werkzaamheden waarbij stof en fijnstof opwaait, dampen en gassen ontstaan of met andere gezondheidsschadelijke stoffen wordt omgegaan. Bescherm bij alle werkzaamheden uw luchtwegen tegen deze gevaren. Hiervoor heeft kwb een omvangrijk assortiment veiligheidsmaskers, met en zonder ademventielen.

Voor alle gangbare toepassingen in de voorgeschreven beschermingsklassen.



HSS-trappenboren



Trappenboren, HSS met aanboorpunt, voor het boren van kleine tot grote gaten zonder voorboren in de dunste platen, geen bramen dankzij de afkanter, geen koudlassen, getrapt volgens de meest gangbare boordiameters, voor plaatstaal, non-ferrometalen en kunststof.

Art.-nr.	Kopdiameter	Toename			EAN
525820	4 - 20 mm	2 mm		1	4 009315 258201
525830	6 - 30 mm	2 mm		1	4 009315 258300

HSS-plaatboren

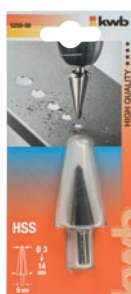

Plaatboren, HSS met aanboorpunt, voor het traploos boren van kleine tot grote gaten zonder voorboren in de dunste platen, geen bramen dankzij de afkanter, geen koudlassen, voor plaatstaal, non-ferrometalen en kunststof.

Art.-nr.	Kopdiameter	mm			EAN
525000	3 - 14 mm	10		1	4 009315 250007
525100	6 - 20 mm	10		1	4 009315 251004
525200	16 - 30 mm	10		1	4 009315 252001

Antennefrees, WS

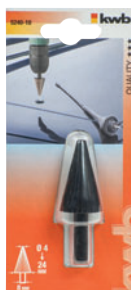
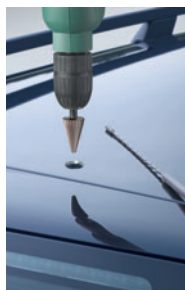

Antennefrees, WS, voor traploos boren van kleine tot grote diameters in dun non-ferrometaal, kunststof en hout, ook geschikt voor de inbouw van antennes in voertuigen.

Art.-nr.	Kopdiameter	mm			EAN
524010	4 - 24 mm	8		6	4 009315 240107

TITAAN HSS-boren

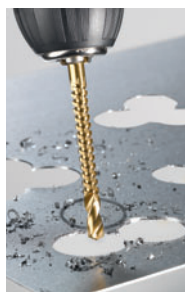

Freesboren, HSS, TITAAN genitreerd, om te boren en te frezen, voor het maken van slobgaten en het verbreden van gaten, voor plaatstaal, non-ferrometalen en kunststof, bijzonder geschikt voor professioneel continu gebruik.

Art.-nr.	Ø mm			EAN
494100	6		1	4 009314 941005



## HSS-freesboren



Freesboren, HSS, om te boren en te frezen, voor het maken van slobgaten en het verbreden van gaten, voor plaatstaal, non-ferrometalen en kunststof.

Art.-nr.	Ø mm			EAN
493900	6		6	 4 009314 939002



## Freesboren WS



Freesboren, WS, om te boren en te frezen, voor het maken van slobgaten en het verbreden van gaten, voor hout- en kunststofbewerking.

Art.-nr.	Ø mm			EAN
494000	6		6	 4 009314 940008



## kwb-Info

### Een kwestie van veiligheid



Ons oog is een van onze belangrijkste zintuigen en moet dus bij alle werkzaamheden worden beschermd.

Daarom heeft kwb voor alle gangbare binnen- en buitentoeepassingen, zoals boren, frezen, slijpen en lassen, een hoogwaardig, ook voor brildraggers geschikt assortiment veiligheidsbrillen samengesteld.

Alle informatie hierover vindt u in onze kwb-folder voor arbeidsveiligheid of op het internet op [www.kwb.eu](http://www.kwb.eu)



**Boormobiel**



Boormobiel, voor boormachines met Ø 43mm-eurohals, zwenkbare geleiding met 2 stangen, 90-45°, om nauwkeurig horizontaal, verticaal of in een hoek te boren, traploze diepte-instelling, rechte aanslag voor serieboringen op één lijn, geïntegreerde V-gleuf voor een veilige bevestiging van ronde materialen.

Art.-nr.	voor			EAN
778400	Boormachines met Ø 43 mm-eurohals		1	4 009317 784005

**Boormachinehouder**



Boormachinehouder, voor boormachines met Ø 43mm-eurohals, 360° verdraaibaar, 90° verticaal zwenkbaar, kan horizontaal en verticaal inklemmen, voor een snel stationair gebruik van boormachines, frees- en schuurmachines op werkbanken, werktafels en tafelbladen om te schuren, te scherpen, te reinigen en te polijsten.

Art.-nr.	voor			EAN
779600	Boormachines met Ø 43 mm-eurohals		1	4 009317 796008

**PROFESSIONELE boorstandaard**



Geschikt voor alle gangbare boormachines met eurohals Ø 43 mm, voor nauwkeurig boren en frezen in houten of metalen profielen, incl. terughaalveer, diepteaanslag en mm-schaal. Grondtafel van machinegietijzer 175 x 210 mm met bevestigingssleuven voor bankschroef (art.-nr. 777068, 80 mm, niet bijgeleverd). Totale hoogte 500 mm, 6 kantkrom traploos draaibaar over 360°, kolom-Ø 34 mm, uitlading 130 mm.

Art.-nr.	Inhoud			EAN
777800	Professionele boorstandaard		1	4 009317 778004

**Flexibele as**



Flexibele as, lengte 950 mm, met snelspanboorhouder zonder sleutel, lichte uitvoering, met speciale onderhoudsvrije glijlagers, voor max. 3.000 rpm, voor de fijne bewerking en het fijn handmatig frezen van hout, kunststof, ijzer, non-ferrometalen, ook ideaal voor modelbouw en graveerwerkzaamheden.

Art.-nr.	Lengte		mm	Spanbe-reik	As Ø mm			EAN
522300	950		6	0.5 - 6	3,2		1	4 009315 223001

**Rolsteunbok**



Rolsteunbok, opklapbaar, traploos verstelbare werkhoogte, 650-1.100 mm, bruikbaar met alle normaal verkrijgbare machines en werkbanken, voor het opleggen en verrollen van lange planken, vloerplanken, platen, staven en ronde metalen voorwerpen, dankzij de gelagerde steunrol wordt het materiaal gemakkelijk naar de bewerkingsinrichting gevoerd.



Art.-nr.	Lengte			EAN
785900	300		1	4 009317 859000

## Boormachinetoebehoren

### Keramische slijpstift



Keramische slijpstiften, edelkorund, om bramen te verwijderen, lasnaden glad te maken en oppervlakken fijn te schuren, voor metaal, glas, keramiek en kunststof, voor gebruik in boormachines en rechte slijpers, max. 30.000 rpm.



Art.-nr.	Vorm	Kop-Ø x hoogte			EAN
551000	Cilindrisch	25 x 25 mm		6	4 009315 510002



### Keramische slijpstift



Keramische slijpstiften, edelkorund, om bramen te verwijderen, lasnaden glad te maken en oppervlakken fijn te schuren, voor metaal, glas, keramiek en kunststof, voor gebruik in boormachines en rechte slijpers, max. 30.000 rpm.

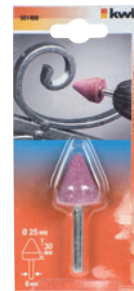
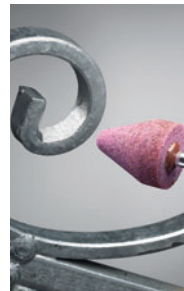

Art.-nr.	Vorm	Kop-Ø x hoogte			EAN
551400	Kegel rond	25 x 32 mm		6	4 009315 514000



### Keramische slijpstift



Keramische slijpstiften, edelkorund, om bramen te verwijderen, lasnaden glad te maken en oppervlakken fijn te schuren, voor metaal, glas, keramiek en kunststof, voor gebruik in boormachines en rechte slijpers, max. 30.000 rpm.



Art.-nr.	Vorm	Kop-Ø x hoogte			EAN
551700	Kegel spits	25 x 32 mm		6	4 009315 517001



### Keramische slijpstift



Keramische slijpstiften, edelkorund, om bramen te verwijderen, lasnaden glad te maken en oppervlakken fijn te schuren, voor metaal, glas, keramiek en kunststof, voor gebruik in boormachines en rechte slijpers, max. 30.000 rpm.

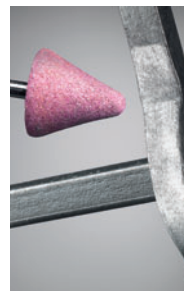

Art.-nr.	Vorm	Kop-Ø x hoogte			EAN
552300	Kegel spits	30 x 30 mm		6	4 009315 523002



### Keramische slijpstift



Keramische slijpstiften, edelkorund, om bramen te verwijderen, lasnaden glad te maken en oppervlakken fijn te schuren, voor metaal, glas, keramiek en kunststof, voor gebruik in boormachines en rechte slijpers, max. 30.000 rpm.

Art.-nr.	Vorm	Kop-Ø x hoogte			EAN
553000	Cilindrisch	16 x 32 mm		6	4 009315 530000



**Keramische slijpstift**

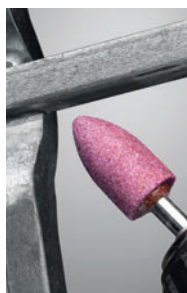

Keramische slijpstiften, edelkorund, om bramen te verwijderen, lasnaden glad te maken en oppervlakken fijn te schuren, voor metaal, glas, keramiek en kunststof, voor gebruik in boormachines en rechte slijpers, max. 30.000 rpm.

Art.-nr.	Vorm	Kop-Ø x hoogte			EAN
553300	Rol spits	16 x 32 mm		6	4 009315 533001

**Keramische slijpstift**

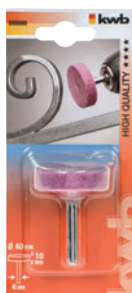

Keramische slijpstiften, edelkorund, om bramen te verwijderen, lasnaden glad te maken en oppervlakken fijn te schuren, voor metaal, glas, keramiek en kunststof, voor gebruik in boormachines en rechte slijpers, max. 30.000 rpm.

Art.-nr.	Vorm	Kop-Ø x hoogte			EAN
555000	Schijf	40 x 10 mm		6	4 009315 555008

**Keramische slijpstift**



Keramische slijpstiften, edelkorund, om bramen te verwijderen, lasnaden glad te maken en oppervlakken fijn te schuren, voor metaal, glas, keramiek en kunststof, voor gebruik in boormachines en rechte slijpers, max. 30.000 rpm.

Art.-nr.	Vorm	Kop-Ø x hoogte			EAN
555200	Schijf spits	40 x 10 mm		6	4 009315 555202

**Keramische slijpstiften, set, 5-delig**



Keramische slijpstiften, set, 5-delig, normaal korund, om bramen te verwijderen, lasnaden glad te maken en oppervlakken fijn te schuren, voor metaal, glas, keramiek en kunststof, voor gebruik in boormachines.





Art.-nr.	Vorm	Kop-Ø x hoogte			EAN
510000	Rol rond, kogel, kegel rond, cilindrisch, kegel spits	15 x 25 mm / 25 x 25 mm / 25 x 43 mm / 25 x 16 mm / 21 x 25 mm		6	4 009315 100005

## Boormachinetoebehoren

### Keramische miniaturslijpstiften, set, 5-delig



Keramische miniaturslijpstiften, set, 5-delig, normaal korund, om bramen te verwijderen, lasnaden glad te maken en oppervlakken fijn te schuren, voor metaal, glas, keramiek en kunststof, voor gebruik in miniboormachinesystemen en flexibele assen.

Art.-nr.	Vorm	Kop-Ø x hoogte			EAN
510100	Rol rond, kegel spits, rolkegel, cilindrisch, kegel rond	16 x 15 mm / 20 x 13 mm / 16 x 15 mm / 13 x 13 mm / 20 x 13 mm		6	 4 009315 101002



### Messen- en scharenslijper



Messen- en scharenslijper, slijpschijf normaal korund, voor het slijpen van alle huishoudelijke messen en scharen met gladde lemmets, voor gebruik met een boormachine.





Art.-nr.	 mm			EAN
493800	6		6	 4 009314 938005



### Wetsteen



Wetsteen, keramische slijper, grof en fijn, korund, voor het slijpen en scherpen van gereedschap zoals bijv. steekbeitels, draaibeitels enz.

Art.-nr.	Afmeting			EAN
455000	150 x 50 x 25 mm		1	 4 009314 550009

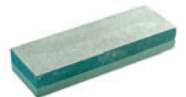

**COMPACTA pomp P57**



COMPACTA pomp P57, zelfaanzuigend, drukregeling, geïntegreerde boormachinehouder, voor boormachines met Ø 43mm-eurohals, met aanzuigfilter, schroefdraadaansluiting R 3/4", voor alle normaal verkrijgbare slangadapters 1/2" en 3/4", voor het over- en wegpompen van vloeistoffen, bijv. het leegmaken van regentonnen of kinderswembaden. Slangaansluiting en slang niet inbegrepen.

Art.-nr.	Inhoud			EAN
505700	Klemschacht 8 mm, transportvermogen 3.000 l/h, transporthoogte 40 m, aanzuighoogte +/- 4 m, druk 4 bar, droog lopen max. 30 s		2	4 009315 057000

**Combi-pomp P60**



Combi-pomp P60, zelfaanzuigend, voor boormachines, schroefdraadaansluiting R 3/4", voor alle normaal verkrijgbare 1/2"- en 3/4"-slangadapters, voor het over- en wegpompen van vloeistoffen, bijv. het leegmaken van regentonnen of kinderswembaden.

Art.-nr.	Inhoud			EAN
506000	Klemschacht 8 mm, transportvermogen 3.000 l/h, transporthoogte 40 m, aanzuighoogte +/- 4 m, druk 4 bar, droog lopen max. 30 s		2	4 009315 060002

**kwb-Info**

**COMPACTA pomp P57**

De zelfaanzuigende COMPACTA pomp P57 met drukregeling en geïntegreerde boormachinehouder is geschikt om vloeistoffen over en weg te pompen.

**Voor het leegmaken van:**

- Tuinvijvers
- Boten
- Aquaria
- Ondergelopen kelders
- Regentonnen
- Kinderzwembaden enz.

**Voor het bewateren van:**

- Tuinen
- Bloemperken

Ook geschikt voor het sproeien van gewasbeschermingsmiddelen.







## Boormachinetoebehoren

### Maxipomp P63



Maxi-pomp P63, zelfaanzuigend, voor boormachines, slangaansluiting 1/2" voor bevestiging met slangklemmen, voor het over- en wegpompen van vloeistoffen, bijv. het leegmaken van regentonnen of kinderzwembaden.

Art.-nr.	Inhoud			EAN
506300	Klemschacht 8 mm, transportvermogen 2.400 l/h, transporthoogte 40 m, aanzuighoogte +/- 4 m, druk 4 bar, droog lopen max. 30 s		4	 4 009315 063003



### Maxipomp P63, display



Maxi-pomp P63, zelfaanzuigend, voor boormachines, slangaansluiting 1/2" voor bevestiging met slangklemmen, voor het over- en wegpompen van vloeistoffen, bijv. het leegmaken van regentonnen of kinderzwembaden.





Art.-nr.	Inhoud			EAN
506399	16		Z16	 4 009315 063997



### Minipomp P61



Mini-pomp P61, zelfaanzuigend, voor boormachines, slangaansluiting 1/2" voor bevestiging met slangklemmen, voor het over- en wegpompen van vloeistoffen, bijv. het leegmaken van regentonnen of kinderzwembaden.



Art.-nr.	Inhoud			EAN
506100	Klemschacht 8 mm, transportvermogen 1.500 l/h, transporthoogte 20 m, aanzuighoogte +/- 3 m, druk 5 bar, droog lopen max. 10 s		4	 4 009315 061009



### Minipomp P61, display



Mini-pomp P61, zelfaanzuigend, voor boormachines, slangaansluiting 1/2" voor bevestiging met slangklemmen, voor het over- en wegpompen van vloeistoffen, bijv. het leegmaken van regentonnen of kinderzwembaden.

Art.-nr.	Inhoud			EAN
506199	25		Z25	 4 009315 061993



Lakmenger



Menger voor lakken, nylon vleugel, voor het mengen van lakken, lazuren en verven, robuuste uitvoering, zeer rustige loop, voor gebruik met normaal verkrijgbare boormachines, mengt het materiaal door de sterke zuigkracht zonder te spatten, zeer geschikt voor kleinere verpakkingen.

Art.-nr.	Ø mm	Vat	Lengte	⌀	☑	📦	EAN
497006	60	max. 5 l	350 mm	6	☑	1	4 0093 14 970067
497008	80	10 - 15 l	400 mm	8	☑	1	4 0093 14 970081

Verfmenger



Menger voor verf, metalen garde, voor het mengen van dispersie- en muurverf en lichte mortel, robuuste uitvoering, zeer rustige loop, met kunststof coating, voor gebruik met gewoon verkrijgbare boormachines, min. 500 watt.

Art.-nr.	Ø mm	Vat	Lengte	⌀	☑	📦	EAN
497206	60	max. 5 l	400 mm	8	☑	1	4 0093 14 972061
497208	80	5 - 15 l	400 mm	8	☑	1	4 0093 14 972085
497210	100	10 - 25 l	590 mm	10	☑	1	4 0093 14 972108
497212	120	20 - 30 l	590 mm	10	☑	1	4 0093 14 972122

Mortelmenger



Menger voor mortel, metalen garde, voor het mengen van mortel, tegelijm, alles soorten pleistermateriaal, robuuste uitvoering, zeer rustige loop, met kunststof coating, laat geen verf los tijdens het gebruik, voor gebruik met alle normaal verkrijgbare boormachines, min. 400 watt, goede vermenging van de stoffen bij een beperkte belasting van de machine.

Art.-nr.	Ø mm	Vat	Lengte	⌀	☑	📦	EAN
497607	70	4 - 7 l	400 mm	8	☑	1	4 0093 14 976076
497609	90	7 - 10 l	400 mm	8	☑	1	4 0093 14 976090
497612	100	10 - 15 l	590 mm	10	☑	1	4 0093 14 976120

Mortelmenger M14



Menger voor mortel, metalen garde, M14-buitenschroefdraad met zeskantstelring, voor het mengen van mortel, cementmortel, ondervloermortel, beton en lijm, robuuste uitvoering, voor een rustige en veilige loop die het reservoir niet beschadigt, gepoedercoat, laat geen verf los tijdens het gebruik, voor gebruik met normaal verkrijgbare roermachines, min. 700 watt.

Art.-nr.	Ø mm	Lengte	☑	📦	EAN
497632	120	590 mm	☑	1	4 0093 14 976328



## Lijmmenger



Menger voor lijm, metalen garde, voor het mengen van oppervlaktelijm, plamuur, tegellijm, pleister en ondervloermortel, robuuste uitvoering, zeer rustige loop, met kunststof coating, laat geen verf los tijdens het gebruik, voor gebruik met alle normaal verkrijgbare boormachines, min. 500 watt, zorgt voor een homogene vermenging, energiezuinig door de ronde stalen staaf.



Art.-nr.	Ø mm	Vat	Lengte	✂	📦	📦	EAN
497708	85	5 - 10 l	400 mm	8	📦	1	4 009 314 977 080
497711	105	10 - 15 l	590 mm	10	📦	1	4 009 314 977 110

## kwb-Info



## Bij kwb wordt ,geroerd', niet geschud!

De mengers van kwb zijn 'Made in Germany' en dus van de hoogste kwaliteit, vervaardigd door de modernste productie-installaties. Alle mengers zijn onderworpen aan een continue kwaliteitscontrole, want alleen met de juiste menger bereikt men de vereiste resultaten.

### Stabiele lasverbindingen

Het gepatenteerde productieproces van de mengers zorgt ervoor dat ze netjes werken, welke stoffen ook worden gemengd.

### Rondomlopende veiligheidsring

Garandeert een rustige en veilige loop van de menger zonder schade aan het mengvat.

### Gepoederlakte oppervlakken

Een coating zonder schadelijke stoffen op de gladde randen en vlakken zorgt voor een aantrekkelijke look en een aangename feel.

Het productieproces verloopt uiteraard milieuvriendelijk zonder emissies.

... altijd de passende toebehoren voor uw machine!





# GATENZAGEN

**Boorkronen**

**Bimetalen gatenzagen**

**Diamantgatenzagen**

**Wolframstalen gatenzagen**

**Meergatenzagen**



## Gatenzagen



### De voordelen van de gatenzagen/boorkronen

- Boorkronen voor het boren van inbouw verdeel- en contactdozen of inbouwspots en voor leidingdoorvoeringen
- Gatenzagen in verschillende uitvoeringen zoals bimetaal, diamant, met hardmetaal bestrooid, wolframstaal, geharde tandpunten

## Programma overzicht gatenzagen/boorkronen



### Holle boorkronen

★★★★★

Holle boorkronen, met hardmetaal of diamant versterkt, voor het boren van gaten voor de inbouw van elektriciteitsdozen en leidingdoorvoeringen, voor gebruik in alle (slag)boormachines.

LET OP! Holle diamantboorkronen mogen alleen draaiend worden gebruikt!

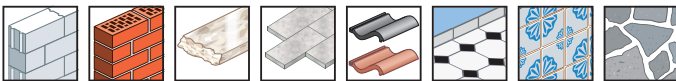

Pagina 128



### Diamantgatenzagen

★★★★★

Diamantgatenzagen voor gres en harde tegels, voor het boren van pluggaten en gaten voor wateraansluitingen, waterafvoerbuizen, verdeel- en contactdozen.

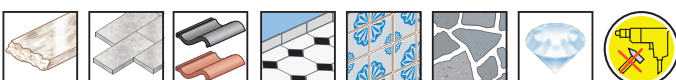

Pagina 132 - 133



### Bimetalen HSS-gatenzagen

★★★★★

Bimetalen HSS-gatenzagen voor metalen, aluminium of sandwichplaten, voor gebruik in alle (slag)boormachines.

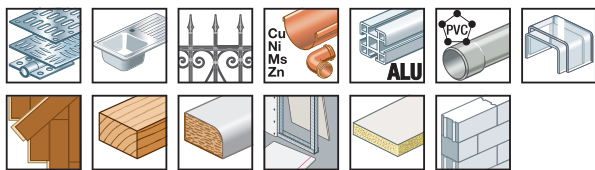

Pagina 129 - 131



### Met hardmetaal bestrooide gatenzagen







★★★★★

Met hardmetaal bestrooide gatenzagen voor hout, kunststof en cellenbeton. Voor de installatie van verdeel- en contactdozen en de plaatsing van buizen.



Pagina 134 - 135

## Welke gatenzaagdiameter is geschikt voor welke toepassing?

Toepassing/gebruik	Gatenzaagdiameter (Ø mm)
 <b>Watersluitingen en -leidingen</b> Elektrische leidingen	12, 14, 16, 20, 25, 30
 <b>Spots en lampen</b>	35, 40, 43, 51, 53, 57, 60, 63, 73, 74, 78, 83, 85, 92, 10, 103
 <b>Buisdoorvoeringen</b>	35, 40, 51, 57, 60, 83, 85
 <b>Contactdozen</b>	65, 67, 68
 <b>Verdeeldozen</b>	68, 83, 85
 <b>Lichtschakelaars</b>	68



### Wolframstalen gatenzagen

★★★★★

Wolframstalen gatenzagen voor hout, spaanplaten en kunststof, voor gaten voor inbouwspots of verdeel- en contactdozen en voor buisdoorvoeringen.

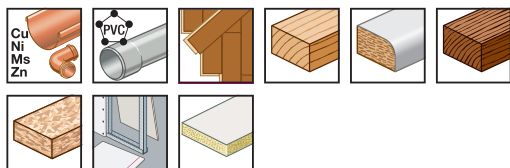

Pagina 136



### Meergatenzagen

★★★★★

Verschillende uitvoeringen, met of zonder geharde tandpunten, voor hout, hardhout, spaanplaten, gipsplaten, lichte bouwplaten en kunststof.

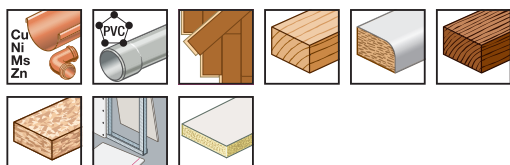

Pagina 137 - 140

## kwb-info



### Een kwestie van veiligheid

Veiligheidshandschoenen moeten worden gedragen bij alle werkzaamheden waarbij handletsels kunnen optreden. Bij al dergelijke toepassingen, bijv. in de bouw, bij voorwerpen met scherpe randen enz., dient men de handen te beschermen.

Bij alle werkzaamheden zijn grip en optimaal draagcomfort basisvoorwaarden voor de juiste veiligheidshandschoenen.

Alle informatie hierover vindt u in onze kwb-folder voor arbeidsveiligheid of op het internet op [www.kwb.eu](http://www.kwb.eu).



## Welke gatenzaag is geschikt voor welke materialen?

De kwb-gatenzagen kunnen worden gebruikt in de meest uiteenlopende materialen. De kwaliteit, de dikte en de dichtheid van het materiaal speelt een grote rol bij de keuze van de juiste gatenzaag.

Programma van gatenzagen	Pagina	Kwaliteit	Metaal	Rvs	Gietijzer	Non-ferrometaal	Alu-minium	Kunststof	Acryl	Laminaat
<b>BOORKRONEN</b>										
1751- Holle boorkroon HARDMETAAL Ø 66 mm und Ø 80 mm	128	★★★★★								
1752- Holle boorkroon DIAMANT Ø 68 mm und Ø 82 mm	128	★★★★★								
<b>EENKRANSGATENZAGEN</b>										
598- Bimetalen HSS variovertanding Ø 16 mm bis Ø 152 mm	129	★★★★★	✓✓✓	✓✓	✓	✓✓✓	✓✓✓	✓	✓	✓
4998- Diamantgatenzagen Ø 5 mm bis Ø 35 mm und Ø 45 mm bis Ø 76 mm	132	★★★★★								
4994- met hardmetaal bestrooid Ø 33 bis Ø 103 mm	134	★★★★★						✓		
4993- Wolframstalen, geharde tandpunten Ø 35 bis Ø 100 mm	136	★★★★★				✓		✓✓		✓
498100 gehard Ø 65 mm	138	★★★★						✓		
498200 gehard Ø 68 mm	138	★★★★						✓		
499000 gehard Ø 80 mm	138	★★★★						✓		
<b>MEERGATENZAGEN</b>										
498300 geharde tandpunten, 3-delig Ø 60, 67, 74 mm	137	★★★★★				✓		✓✓		✓
498800 geharde tandpunten, 6-delig Ø 46, 53, 60, 68, 74, 81 mm	137	★★★★★				✓		✓✓		✓
498700 geharde tandpunten, 7-delig Ø 46, 53, 59, 66, 73, 82, 94 mm	137	★★★★★				✓		✓✓		✓
499700 geharde tandpunten, 5-delig Ø 69, 74, 80, 90, 100 mm	138	★★★★★				✓		✓✓		✓
498900 gehard, 8-delig Ø 25, 32, 38, 44, 51, 57, 63, 68 mm	139	★★★★						✓		
498500 gehard, 5-delig Ø 28, 35, 50, 68, 75 mm	139	★★★★						✓		
599000 Snijdiepte 18 mm, 7-delig Ø 25, 32, 38, 45, 50, 58, 63 mm	139	★★★								
599100 Snijdiepte 50 mm, 7-delig Ø 25, 32, 38, 45, 50, 58, 63 mm	140	★★★								















# Gatenzagen / boorkronen

De tabel biedt een overzicht van de toepassingseigenschappen van de gatenzagen met een indeling volgens:

**GOED = ✓**

**BETER = ✓✓**

**BEST = ✓✓✓**

														
Zacht hout	Spaanplaten (met coating)	Hardhout	Spaanplaten	Gipsplaten	Lichte bouwmaterialen	Cellenbeton	Steen	Marmer	Gres	Dakpannen	Vloertegels	Wandtegels	Natuursteen	Graniet
						✓✓✓	✓✓✓	✓✓✓		✓✓			✓✓	✓
						✓✓✓	✓✓✓	✓✓	✓✓	✓✓✓	✓	✓	✓✓	
✓	✓			✓	✓✓	✓								
								✓✓	✓✓✓	✓✓	✓✓✓	✓✓✓	✓✓	
				✓		✓✓✓	✓				✓✓✓	✓✓✓	✓✓	
✓✓✓	✓✓✓	✓✓✓	✓✓✓	✓✓✓	✓									
✓✓✓	✓✓	✓✓	✓✓	✓✓✓										
✓✓✓	✓✓	✓✓	✓✓	✓✓✓										
✓✓✓	✓✓	✓✓	✓✓	✓✓✓										
✓✓✓	✓✓✓	✓✓✓	✓✓✓	✓✓✓	✓									
✓✓✓	✓✓✓	✓✓✓	✓✓✓	✓✓✓	✓									
✓✓✓	✓✓✓	✓✓✓	✓✓✓	✓✓✓	✓									
✓✓✓	✓✓	✓✓	✓✓	✓✓✓										
✓✓✓		✓		✓✓										
✓✓✓		✓		✓✓										

**Holle boorkroon HARDMETAAL**

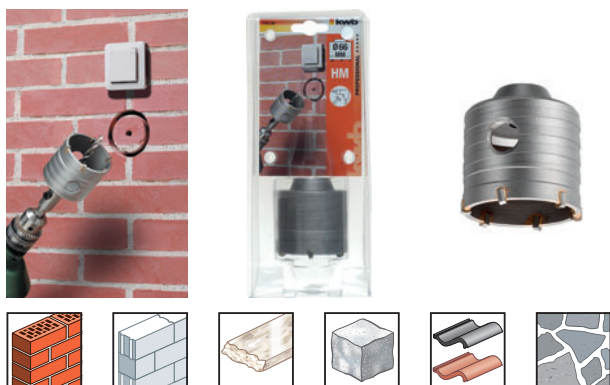

Holle boorkroon met hardmetalen rand, slagboorvast, speciaal gehard, speciaal gesoldeerde hittebestendige hardmetalen platen, voor gebruik in metselwerk, natuursteen, kunststeen, beton, marmer en dakpannen, voor de plaatsing van elektrische inbouwdozen en leidingdoorvoeringen.

Art.-nr.	Ø mm	voor			EAN
175166	66	175300 / 20		1	4 009311 751669
175180	80	175300 / 20		1	4 009311 751805

**Holle boorkroon DIAMANT**



Holle boorkroon met DIAMANT-segmenten, lasergelaste segmenten voor een extra lange bruikbaarheid, snelle zuivere snede, extreem hoge levensduur, moeiteloos werken, voor gebruik in metselwerk, natuursteen, kunststeen, marmer, tegels, gres, keramiek en dakpannen, voor de plaatsing van elektrische inbouwdozen en leidingdoorvoeringen.

Art.-nr.	Ø mm	voor			EAN
175268	68	175300 / 20		1	4 009311 752680
175280	82	175300 / 20		1	4 009311 752802

**Opnameschacht met centreerboor**



Opnameschacht met centreerboor, zeskantopnameschacht SW12 en SDS-plus, schroefdraad M16, geschikt voor alle holle boorkronen, met hardmetaal versterkt, met diamant versterkt, voor gebruik in alle (slag)boormachines.

Art.-nr.	voor	Schroefdraad		mm			EAN
<b>Opnameschacht SW 12</b>							
175300	175166 / 80, 175268 / 80	M 16	SW 12		1		4 009311 753007









































Art.-nr.	voor	Schroefdraad		mm			EAN
<b>Opnameschacht SDS-plus</b>							
175320	175166 / 80, 175268 / 80	M 16	SDS Plus		1		4 009311 753205





## Gatenzaag HSS bimetaal



Art.-nr.	Ø mm	Snijdiepte			EAN
598016	16	32		1	4 009315 980164
598019	19	32		1	4 009315 980195
598020	20	32		1	4 009315 980201
598022	22	32		1	4 009315 980225
598025	25	32		1	4 009315 980256
598030	30	32		1	4 009315 980300
598032	32	32		1	4 009315 980324
598035	35	32		1	4 009315 980355
598038	38	32		1	4 009315 980386
598040	40	32		1	4 009315 980409
598041	41	32		1	4 009315 980416
598044	44	32		1	4 009315 980447
598046	46	32		1	4 009315 980461
598048	48	32		1	4 009315 980485
598051	51	32		1	4 009315 980515
598054	54	32		1	4 009315 980546
598057	57	32		1	4 009315 980577
598060	60	32		1	4 009315 980607
598064	64	32		1	4 009315 980645
598065	65	32		1	4 009315 980652
598067	67	32		1	4 009315 980676
598068	68	32		1	4 009315 980683
598070	70	32		1	4 009315 980706
598073	73	32		1	4 009315 980737
598076	76	32		1	4 009315 980768
598079	79	32		1	4 009315 980799
598083	83	32		1	4 009315 980836
598089	89	32		1	4 009315 980898
598092	92	32		1	4 009315 980928
598095	95	32		1	4 009315 980959
598102	102	32		1	4 009315 981024
598105	105	32		1	4 009315 981055
598108	108	32		1	4 009315 981086
598111	111	32		1	4 009315 981116
598114	114	32		1	4 009315 981147
598121	121	32		1	4 009315 981215
598127	127	32		1	4 009315 981277
598152	152	32		1	4 009315 981529

Gatenzaag, HSS bimetaal, progressieve variovertanding, voor vertraagd uitwerpen van spanen, HSS-vertanding, 5%-KOBALT-legering, extreem sterk, lange levensduur, voor staal, machinegietijzer, bouwstaal, rvs-plaatstaal, aluminium, brons, koper, kunststof, acryl, gipsplaten en hout.



**Opnameschacht voor bimetalen HSS-gatenzagen, Ø 16 - 30 mm**



Opnameschacht voor bimetalen HSS-gatenzagen, met HSS-centreerboor.



Art.-nr.	voor gatenzagen Ø mm	mm			EAN
598800	16-30			1	4 009315 988009
598400	16-30	SDS Plus		1	4 009315 984001

**Opnameschacht voor bimetalen HSS-gatenzagen, Ø 32 - 152 mm**



Opnameschacht voor bimetalen HSS-gatenzagen, speciaal geharde SDS-plus-schacht, met HSS-centreerboor.

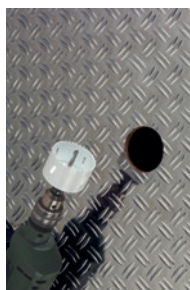

Art.-nr.	voor gatenzagen Ø mm	mm			EAN
598900	32-152			1	4 009315 989006
598500	32-152	SDS Plus		1	4 009315 985008

**Centreerboren HSS voor bimetalen HSS-gatenzagen**



Centreerboren HSS voor bimetalen HSS-gatenzagen.

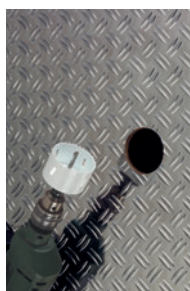

Art.-nr.	Ø mm	Lengte	mm			EAN
598700	6,35	100	6-kant		1	4 009315 987002

## Gatenzagen HSS bimetaal, 8-delig



Art.-nr.	Ø mm	Snijdiepte			EAN
598200	20, 29, 35, 40, 51, 68	32		1	4 009315 982007

Gatenzagen HSS bimetaal, 6 gatenzagen, progressieve variovertanding, voor vertraagd uitwerpen van spanen, HSS-vertanding, 5%-KO-BALT-legering, extreem sterk, lange levensduur, voor staal, machinegietijzer, bouwstaal, rvs-plaatstaal, aluminium, brons, koper, kunststof, acryl, gipsplaten en hout, 2 opnameschachten voor bimetalen HSS-gatenzagen, speciaal geharde zeskantschacht, met HSS-centreerboor.

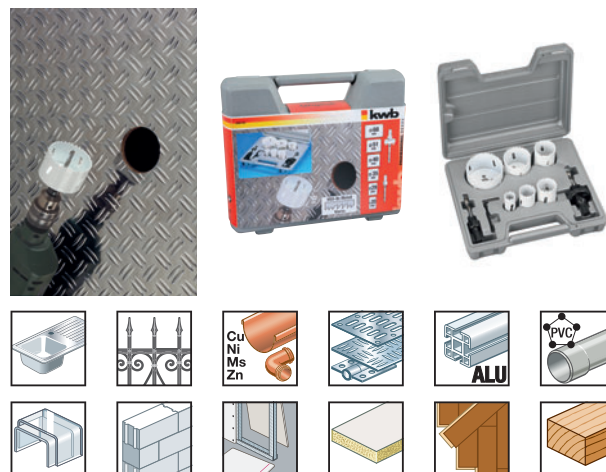

## Gatenzagen HSS bimetaal, met schacht en centreerboor



Art.-nr.	Ø mm	Snijdiepte			EAN
598520	20	38		1	4 009315 985206
598522	22	38		1	4 009315 985220
598525	25	38		1	4 009315 985251
598529	29	38		1	4 009315 985299
598532	32	38		1	4 009315 985329
598535	35	35		1	4 009315 985350
598540	40	38		1	4 009315 985404
598545	45	38		1	4 009315 985459
598551	51	38		1	4 009315 985510
598556	56	38		1	4 009315 985565
598565	65	38		1	4 009315 985657
598568	68	38		1	4 009315 985688
598574	74	38		1	4 009315 985749
598583	83	38		1	4 009315 985831

Gatenzagen HSS bimetaal, met schacht en centreerboor, progressieve Vario-vertanding voor vertraagd uitwerpen van spanen, HSS-vertanding, sterk, hoge levensduur, voor staal, machinegietijzer, bouwstaal, plaatstaal, aluminium, brons, koper, kunststof, acryl, gipsplaten en hout.

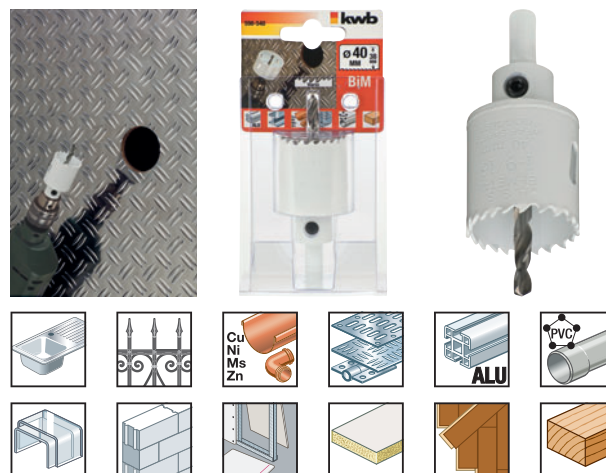

**Gatenzagen met DIAMANT bestrooid**



Gatenzagen, met DIAMANT bestrooid, hoogwaardige industriële diamanten, kan zelfs worden gebruikt in de hardste tegels, massieve gedraaide basis, precies, met hoge concentriciteit Ø 5 tot 35 mm voor pluggaten, wateraansluitingen, en waterleidingen en Ø 45 tot 82 mm voor waterafvoerbuizen en verdeler- en contactdozen, voor gres, graniet, tegels, keramiek, natuursteen en marmer.

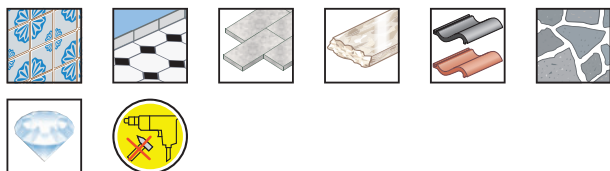

Art.-nr.	Ø mm	Snijdiepte			EAN
<b>voor pluggaten, wateraansluitingen en waterleidingen</b>					
499805	5	25		1	4 0093 14 998054
499806	6	25		1	4 0093 14 998061
499807	7	25		1	4 0093 14 998078
499808	8	25		1	4 0093 14 998085
499810	10	25		1	4 0093 14 998108
499812	12	25		1	4 0093 14 998122
499814	14	25		1	4 0093 14 998146
499816	16	25		1	4 0093 14 998160
499820	20	25		1	4 0093 14 998207
499825	25	25		1	4 0093 14 998252
499830	30	25		1	4 0093 14 998306
499835	35	25		1	4 0093 14 998351

Art.-nr.	Ø mm	Snijdiepte			EAN
<b>voor afvoerleidingen, verdeel- en stekkerdozen</b>					
499845	45	25		1	4 0093 14 998450
499850	50	25		1	4 0093 14 998504
499868	68	25		1	4 0093 14 998689
499876	76	25		1	4 0093 14 998764

**Watersysteem en boorhulp**



Watersysteem en boorcentrering, voor diamantgatenzagen van Ø 5 tot 35 mm.



Art.-nr.	voor gatenzagen Ø mm			EAN
499800	5 - 35		1	4 0093 14 998009

## Gatenzagen

### Boormal voor gatenzagen



Boormal voor gatenzagen DIAMANT, van Ø 40 tot 82 mm, voor gebruik samen met het watersysteem kwb-artikel 499802.

Art.-nr.	voor gatenzagen Ø mm			EAN
499801	45 - 82		1	4 009314 998016



### Watersysteem met slang voor DIAMANT-gatenzagen



Watersysteem met slang voor DIAMANT-gatenzagen, voor gebruik met de gatenzaagcentreerhulp, kwb-artikel 499801.

Art.-nr.	voor			EAN
499802	499801		1	4 009314 998023

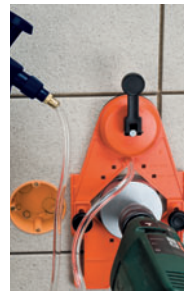

### Gatenzagenset DIAMANT, 8-delig



Gatenzagenset DIAMANT, 8-delig, 7 gatenzagen met DIAMANT bestrooid, hoogwaardige industriële diamanten, kan zelfs worden gebruikt in de hardste tegels, massieve gedraaide basis, precies, met hoge concentriciteit, voor pluggaten, passende boorsjablonen met zuignap en wateraansluitingen, voor gres, graniet, tegels, keramiek, natuursteen en marmer.

Art.-nr.	Inhoud			EAN
499900	Ø 4, 5, 6, 7, 8, 10, 12 + diamantborensset met boormal		1	4 009314 999006

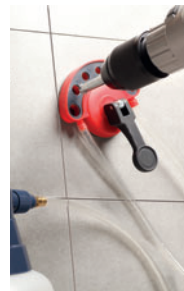

**Gatenzaag met hardmetaal bestrooid, compleet met steunschijf en centreerboor**

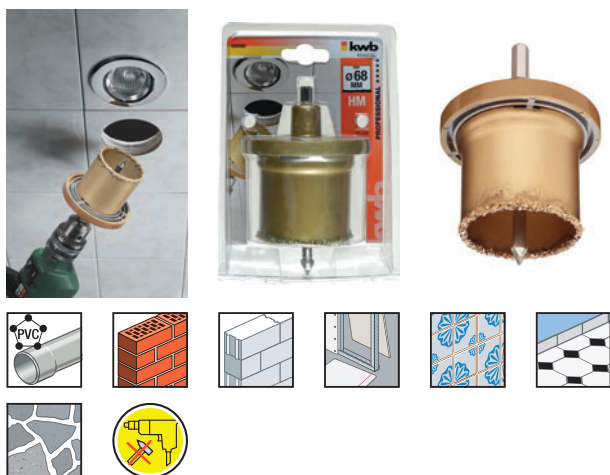

Gatenzaag, met hard metaal bestrooid, compleet met steunschijf en centreerboor, precisiebuis, bestrooid met speciaal hardmetaalsplit, bij hoge temperatuur gesoldeerd, voor cellenbeton, metselwerk, tegels, keramiek, natuursteen, lichte bouwplaten, gipsplaten en kunststof, voor installatiewerkzaamheden zoals bijv. inbouw van contact- en verdeel dozen en plaatsing van leidingen.

Art.-nr.	Ø mm	Snijdiepte			EAN
499460	68	55		2	4 009314 994605
499480	83	55		2	4 009314 994803

**Gatenzaag met hardmetaal bestrooid**



Gatenzaag, met hard metaal bestrooid, drager precisiebuis, bestrooid met speciaal hardmetaalsplit, bij hoge temperatuur gesoldeerd, voor cellenbeton, metselwerk, tegels, keramiek, natuursteen, lichte bouwplaten, gipsplaten en kunststof, voor installatiewerkzaamheden zoals bijv. inbouw van contact- en verdeel dozen en plaatsing van leidingen.

Art.-nr.	Ø mm	Snijdiepte			EAN
499403	33	55		2	4 009314 994032
499404	43	55		2	4 009314 994049
499405	53	55		2	4 009314 994056
499406	63	55		2	4 009314 994063
499426	67	55		2	4 009314 994261
499407	73	55		2	4 009314 994070
499408	83	55		2	4 009314 994087
499450	103	55		2	4 009314 994506

**Steunschijf voor met hardmetaal bestrooide gatenzagen**



Steunschijf voor met hardmetaal bestrooide gatenzagen.

Art.-nr.	voor gatenzagen Ø mm			EAN
499420	33 - 83		2	4 009314 994209
499430	70 - 103		2	4 009314 994307

## Gatenzagen

### Centreerboren voor met hardmetaal bestrooide gatenzagen



Centreerboren voor met hardmetaal bestrooide gatenzagen, passend voor alle met hardmetaal versterkte gatenzagen, speciale boren voor een gemakkelijke start zonder weg te schieten.





Art.-nr.	Ø mm			EAN
499410	9		1	



### Gatenzagenset met hardmetaal bestrooid, 7-delig



Gatenzagenset, met hard metaal bestrooid, 5 gatenzagen, drager precisiebuis, bestrooid met speciaal hardmetaalsplint, bij hoge temperatuur gesoldeerd, voor cellenbeton, metselwerk, tegels, keramiek, natuursteen, lichte bouwplaten, gipsplaten en kunststof, voor installatiewerkzaamheden zoals bijv. inbouw van contact- en verdeelkasten en plaatsing van leidingen, met centreerboor en steunschijf.

Art.-nr.	Inhoud			EAN
499507	Ø 33, 53, 67, 71, 83 mm, steunschijf, centreerboor		1	



## kwb-Info

### Een kwestie van veiligheid

Ons oog is een van onze belangrijkste zintuigen en moet dus bij alle werkzaamheden worden beschermd. Daarom heeft kwb voor alle gangbare binnen- en buitentoepassingen, zoals boren, frezen, slijpen en lassen, een hoogwaardig, ook voor bril dragers geschikt assortiment veiligheidsbrillen samengesteld.

Alle informatie hierover vindt u in onze kwb-folder voor arbeidsveiligheid of op het internet op [www.kwb.eu](http://www.kwb.eu)



**Wolframstalen gatenzaag, met schacht en centreerboor**



Wolframstalen gatenzaag met schacht en centreerboor, plaatstalen steunschijf, wolframstalen zaagkrans, geharde tandpunten, vast geschroefd op de steunschijf, beperkte tolerantie, voor hout, hout met kunststof coating, hardhout, spaanplaten, gipsplaten, lichte bouwplaten, kunststof en koper, voor de installatie van inbouwspots en contact- of verdeelkasten en het maken van buisdoorvoeringen.

Art.-nr.	Ø mm	Snijdiepte			EAN
499300	68	40		1	4 009314 993004
499303	68, 83, 100	40		1	4 009314 993035

**Wolframstalen gatenzaag**



Wolframstalen gatenzaag, plaatstalen steunschijf, wolframstalen zaagkrans, geharde tandpunten, vast geschroefd op de steunschijf, beperkte tolerantie, voor hout, hout met kunststof coating, hardhout, spaanplaten, gipsplaten, lichte bouwplaten, kunststof en koper, voor de installatie van inbouwspots en contact- of verdeelkasten en het maken van buisdoorvoeringen.

Art.-nr.	Ø mm	Snijdiepte			EAN
<b>Dubbele blister</b>					
499335	35	40		1	4 009314 993356
499340	40	40		1	4 009314 993400
499352	51	40		1	4 009314 993523
499357	57	40		1	4 009314 993578
499360	60	40		1	4 009314 993608
499368	68	40		1	4 009314 993684
499374	74	40		1	4 009314 993745
499378	78	40		1	4 009314 993783
499383	83	40		1	4 009314 993837
499392	92	40		1	4 009314 993929
499399	100	40		1	4 009314 993998

**Opnameschacht voor wolframstalen gatenzagen**



Opnameschacht voor wolframstalen gatenzagen, speciaal geharde zeskantschacht, met HSS-centreerboor.

Art.-nr.	Ø mm	mm			EAN
<b>Opnameschacht SW 10</b>					
499310	5	● 10		1	4 009314 993103





# Gatenzagen

## Meergatenzagen, 3-delig



Gatenzaag, 3-delig, zware zinken gespuitsgiete steunschijf, zaagkrans van gehard veerstaal, tandpunten inductief gehard, voor gebruik in hout, hout met kunststof coating, hardhout, spaanplaten, gipsplaten, lichte bouwplaten, kunststof en koper.



Art.-nr.	Ø mm	Snijdiepte			EAN
498300	60, 67, 74	30		4	



## Meergatenzagen, 6-delig



Gatenzaag, 6-delig, zware zinken gespuitsgiete steunschijf, zaagkrans van gehard veerstaal, tandpunten inductief gehard, voor gebruik in hout, hout met kunststof coating, hardhout, spaanplaten, gipsplaten, lichte bouwplaten, kunststof en koper.

Art.-nr.	Ø mm	Snijdiepte			EAN
498800	46, 53, 60, 68, 74, 81	32		2	

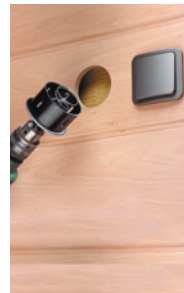

## Meergatenzagen, 7-delig



Gatenzaag, 7-delig, zware zinken gespuitsgiete steunschijf, zaagkrans van gehard veerstaal, tandpunten inductief gehard, voor gebruik in hout, hout met kunststof coating, hardhout, spaanplaten, gipsplaten, lichte bouwplaten, kunststof en koper.

Art.-nr.	Ø mm	Snijdiepte			EAN
498700	46, 53, 59, 66, 73, 82, 94	30		2	

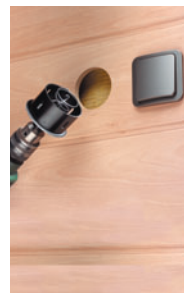

**Meerkransengatenzagen, 5-delig**

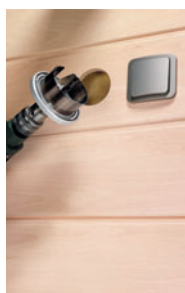

Gatenzaag, 5-delig, zware zinken gespuitsgiete steunschijf, zaagkrans van gehard veerstaal, tandpunten inductief gehard, voor gebruik in hout, hout met kunststof coating, hardhout, spaanplaten, gipsplaten, lichte bouwplaten, kunststof en koper.

Art.-nr.	Ø mm	Snijdiepte			EAN
499700	68, 74, 80, 90, 100	32		2	4 009314 997002

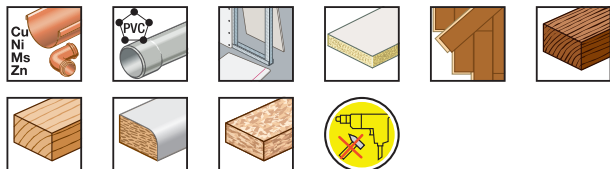

**Gatenzagen, 1-delig**



Gatenzaag, 1-delig, zware zinken gespuitsgiete steunschijf, zaagkrans van gehard veerstaal, voor gebruik in hout, spaanplaten, gipsplaten en lichte bouwplaten.

Art.-nr.	Ø mm	Snijdiepte			EAN
498100	65	28		4	4 009314 990005
498200	68	28		4	4 009314 982008

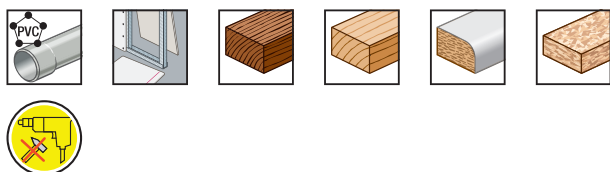

**Gatenzagen, 1-delig**



Gatenzaag, 1-delig, zware zinken gespuitsgiete steunschijf, zaagkrans van gehard veerstaal, voor gebruik in hout, spaanplaten, gipsplaten en lichte bouwplaten.

Art.-nr.	Ø mm	Snijdiepte			EAN
499000	80	28		4	4 009314 990005

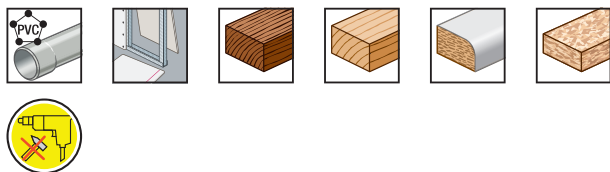

# Gatenzagen

## Meergatenzagen, 8-delig



Gatenzaag, 8-delig, zware zinken gespuitgiete steunschijf, zaagkrans van gehard veerstaal, voor gebruik in hout, spaanplaten, gipsplaten en lichte bouwplaten.

Art.-nr.	Ø mm	Snijdiepte			EAN
498900	25, 32, 38, 44, 51, 57, 63, 68	28		4	4 009314 989007



## Meergatenzagen, 5-delig



Gatenzaag, 5-delig, zware zinken gespuitgiete steunschijf, zaagkrans van gehard veerstaal, voor gebruik in hout, spaanplaten, gipsplaten en lichte bouwplaten.

Art.-nr.	Ø mm	Snijdiepte			EAN
498500	28, 35, 50, 68, 75	30		2	4 009314 985009



## Meergatenzagen, 7-delig



Gatenzaag, 7-delig, steunschijf van gietaluminium, zaagkrans van gehard veerstaal, voor gebruik in hout, gipsplaten en lichte bouwplaten.

Art.-nr.	Ø mm	Snijdiepte			EAN
599000	25, 32, 38, 45, 50, 58, 63	18		4	4 009315 990002



**Meergatenzagen, 7-delig**



Gatenzaag, 7-delig, steunschijf van gietaluminium, zaagkrans van gehard veerstaal, voor gebruik in hout, gipsplaten en lichte bouwplaten.

Art.-nr.	Ø mm	Snijdiepte			EAN
599100	25, 32, 38, 45, 50, 58, 63	40		4	4 009315 991009

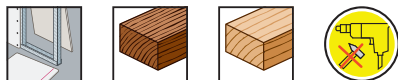

**Gatenzagenset 4-delig met accu-opnameschacht**



Met accu-opnameschacht 1/4" E 6.3 speciaal voor accuschroefboren zoals BOSCH UNEO en mini-accuschroefboren zoals BOSCH IXO. Ideaal om gaten te boren voor inbouwhalogeenspots.

Art.-nr.	Ø mm			EAN
497900	26, 35, 40, 52		6	4 009314 979008

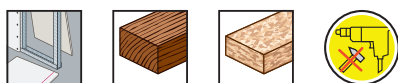



# BORSTELS

**AGGRESSO POWER borstels**

**HSS-staaldraadborstels**

**Messingborstels**

**Rvs-borstels**

**Schuurnylonborstels**

## Borstels



### De voordelen van de borstels

- Gebruik in gewone boormachines
- Snel bewerken en grondig reinigen van metselwerk, verwijderen van roest en verf
- Zuiver polijsten
- Ontbramen
- Gladmaken van scherpe randen
- Vervaardigd van HSS-staaldraad, messing, rvs of schuurnylon

## Programma overzicht borstels



### AGGRESSO POWER borstels ★★★★★

Zeer elastisch, materiaalvriendelijk, om te ontroesten, te decaperen, lak, verf en coatings te verwijderen en metselwerk, pleisterwerk en betonoppervlakken te reinigen.

Pagina 144



### HSS-staaldraad- borstels ★★★★★

HSS-staaldraadborstels voor gebruik in alle (slag) boormachines. Om te ontroesten, te reinigen, te decaperen, verf te verwijderen en te ontbramen.

Pagina 145 - 148



### Messingborstels ★★★★★

Messingborstels voor alle schuur- en polijstwerkzaamheden op metaal en steen, hoge corrosiebescherming.

Pagina 149



### Rvs-borstels ★★★★★

Rvs-borstels om te ontroesten, te reinigen en te ontbramen op rvs en alle metaal- en houtsoorten in buitentoepassingen. Laat geen roestende resten achter.

Pagina 149



### Schuurnylonborstels ★★★★★

Schuurnylonborstels om te reinigen, verf en lak te verwijderen en zacht te polijsten, voor hout, metaal en non-ferrometaal.

Pagina 150

## Belangrijke veiligheidsinstructies

Voor een efficiënt en veilig gebruik, kiest u altijd de maximale borsteldiameter die op het aandrijfapparaat mag worden gemonteerd.

Aangezien door de borsteldiameter de omtreksnelheid wordt bepaald, kan met deze factor ook het vermogen van een borstel worden beïnvloed.

Een overzicht vindt u in nevenstaande tabel.

### Montage-instructies

Voor de montage van de borstels dient u het volgende in acht te nemen:

- Het toerental van de aandrijfas van uw machine mag het maximale veiligheidstoerental van de borstel niet overschrijden
- De lengte van de aandrijfas moet voldoende zijn om een absoluut vaste zitting van de spilmoer te kunnen garanderen
- Borstels met een klemschacht kunnen probleemloos in gewone boorhouders of klemtangen worden gemonteerd
- De aansluitschroefdraad van de borstels is voorzien van een sleutelvlak, waardoor een eenvoudige montage en demontage is gegarandeerd

### Veilige omtreksnelheden:

Als richtwaarden voor veilige omtreksnelheden gelden bijv. ca. 30 - 35 m/s bij borstels met golvende draad en 18 - 22 m/s bij borstels van schuurnylon of met kunststof gebonden materiaal.

Voor borstels met gevlochten draden op haakse slijpers bedraagt de snelheid max. 85 m/s en op stationaire machines max. 45 m/s.

**Belangrijk: Handmachines mogen alleen met borstels met een buitendiameter van max. 180 mm worden gebruikt.**

UPM min <sup>-1</sup>	Borsteldiameter in mm											
	20	40	50	80	100	125	150	180	200	250	300	350
	Omtreksnelheid m/s											
<b>800</b>				3,35	4,19	5,23	6,28	7,53	8,37	10,47	12,56	14,75
<b>900</b>			2,35	3,77	4,71	5,88	7,06	8,48	9,41	11,77	14,12	16,47
<b>1.150</b>			3,01	4,81	6,01	7,52	9,02	10,83	12,03	15,04	18,04	21,04
<b>1.200</b>	1,25	2,51	3,14	5,02	6,28	7,85	9,41	11,30	12,55	15,69	18,83	21,97
<b>1.400</b>	1,46	2,93	3,66	5,86	7,32	9,15	10,98	13,18	14,64	18,31	21,97	25,63
<b>1.500</b>	1,57	3,14	3,92	6,28	7,85	9,81	11,77	14,13	15,69	19,61	23,54	27,46
<b>1.800</b>	1,88	3,77	4,71	7,54	9,41	11,77	14,12	16,95	18,83	23,54	28,24	32,95
<b>2.000</b>	2,09	4,19	5,23	8,37	10,26	13,08	15,69	18,84	20,92	26,15	31,38	36,61
<b>2.500</b>	2,62	5,23	6,54	10,47	13,08	16,35	19,61	23,55	26,15	32,67	39,23	45,76
<b>2.800</b>	2,93	5,86	7,32	11,72	14,64	18,31	21,97	26,37	29,29	36,61	43,93	51,25
<b>3.000</b>	3,14	6,28	7,85	12,56	15,69	19,62	23,54	28,26	31,38	39,23	47,07	54,92
<b>3.200</b>	3,35	6,70	8,37	13,40	16,74	20,92	25,10	30,14	33,47	41,84	50,12	58,58
<b>3.500</b>	3,66	7,33	9,15	14,65	18,31	22,89	27,46	32,97	36,61	45,76	54,92	64,07
<b>4.000</b>	4,19	8,37	10,46	16,75	20,92	26,16	31,38	37,68	41,84	52,33	62,76	73,22
<b>4.500</b>	4,70	9,42	11,77	18,84	23,54	29,43	35,30	42,40	47,07	58,84	70,61	82,43
<b>5.000</b>	5,23	10,47	13,08	20,93	26,15	32,70	39,23	47,10	52,33	65,38	78,50	
<b>5.400</b>	5,65	11,30	14,12	22,94	28,24	35,31	42,36	50,67	56,48	70,61	84,78	
<b>6.000</b>	6,28	12,56	15,69	25,12	31,38	39,24	47,07	56,52	62,76	78,50		
<b>7.000</b>	7,33	14,66	18,31	29,31	36,61	45,78	54,92	65,94	73,22	91,58		
<b>8.000</b>	8,37	16,75	20,92	33,94	41,48	52,32	62,76	75,36	83,73			
<b>9.000</b>	9,42	18,84	23,54	37,68	47,07	58,86	70,61	84,78	94,20			
<b>10.000</b>	10,47	20,93	26,17	41,86	52,33	65,40	78,50	94,20				
<b>12.500</b>	13,08	26,17	32,71	52,33	65,42	81,75	98,13					
<b>15.000</b>	15,70	31,40	39,25	62,80								
<b>17.500</b>	18,32	36,63	45,79	73,26								
<b>20.000</b>	20,93	41,87	52,33	83,73								
<b>22.500</b>	23,55	47,10	58,88	94,20								
<b>25.000</b>	26,17	52,33	65,42	104,66								

## Borstelmateriaal: het beste materiaal voor elke toepassing.

### HSS-staaldraad, golvend/gevlochten

- Hoogwaardige draad met hoge trekvastheid
- Hoge breukrek en lange levensduur
- Voor extreme toepassingen

### Rvs-staaldraad, golvend

- Gewone legering 1.4310 (1.4401 / 1.4571 op aanvraag)
- Toepassingen waar resten van normale draad de te bewerken oppervlakken kunnen aantasten

### Messingdraad, golvend

- Oppervlakfinish van koper en messing

### Vermessingde staaldraad, monodraad, golvend

- Enkelvoudige draden
- Hoge trekvastheid
- Voor veeleisende borstel- en ontbraamwerkzaamheden

### Schuurnylon, siliciumcarbide, golvend

- Met siliciumcarbide vermengde nylon draad
- Gelijmatig schuureffect door het continu vrijgeven van schuurmiddel.
- Hoge elasticiteit zonder breukgevaar
- Lange levensduur
- Om te ontbramen, te ontroesten, op te ruwen en te schuren

**AGGRESSO POWER universele borstelset**



AGRESSO POWER universele borstelset, bestaand uit een klemrijrichting, borstelband en inbussleutel, U-vormig gebogen staaldraad, rechte vorm, ingebracht in flexibele borstelband, extreem elastisch, materiaalvriendelijk, om te ontroesten, te decaperen, te ontslakken, lak, verf en coatings te verwijderen, houten oppervlakken grof te reinigen en vloerbekistingen te reinigen.

Art.-nr.	Ø mm			EAN
602500	110		1	4 009316 025000

**AGRESSO POWER reinigingsborstelset**



AGRESSO POWER reinigingsborstelset, bestaand uit een klemrijrichting, borstelband en inbussleutel, U-vormig gebogen staaldraad, gebogen vorm, ingebracht in flexibele borstelband, extreem elastisch, materiaalvriendelijk, om te ontroesten, lak, verf en coatings te verwijderen, metselwerk te reinigen, gipsresten te verwijderen, betonoppervlakken te reinigen en vloerbekistingen te reinigen.

Art.-nr.	Ø mm			EAN
602600	110		1	4 009316 026007

**kwb-Info**

**Een kwestie van veiligheid**

Er zijn veel werkzaamheden waarbij stof en fijnstof opwaait, dampen en gassen ontstaan of met andere gezondheidsschadelijke stoffen wordt omgegaan.

Bescherm bij alle werkzaamheden uw luchtwegen tegen deze gevaren. Hiervoor heeft kwb een omvangrijk assortiment veiligheidsmaskers, met en zonder ademventielen.

Voor alle gangbare toepassingen in de voorgeschreven beschermingsklassen.

Alle informatie hierover vindt u in onze kwb-folder voor arbeidsveiligheid of op het internet op [www.kwb.eu](http://www.kwb.eu)





## Borstels

### Schijfborstel, HSS-staaldraad, golvend



Schijfborstel, HSS-staaldraad, golvend, om te ontroesten, te reinigen, verf, hamerslag, verkorstingen en bramen te verwijderen, voor metaal en steen, ideaal voor werkzaamheden op smalle randen, ramen, palen, roosters en buizen.

Art.-nr.	Draad	Draad Ø mm	Ø mm	mm			EAN
<b>ZB-doos</b>							
607310	fijn	0,2	75	6		6	4 009316 073100
607330	grof	0,35	75	6		6	4 009316 073308
607410	fijn	0,2	100	6		6	4 009316 074107
607430	grof	0,35	100	6		6	4 009316 074305

Art.-nr.	Draad	Draad Ø mm	Ø mm	mm			EAN
<b>Los in doos</b>							
607333	grof	0,35	75	6		Z25	4 009316 073339
607433	grof	0,35	100	6		Z15	4 009316 074336



### Schijfborstel, dubbeldik, HSS-staaldraad, golvend



Schijfborstel, HSS-staaldraad, golvend, om te ontroesten, te reinigen, verf, hamerslag, verkorstingen en bramen te verwijderen, voor metaal en steen, ideaal voor werkzaamheden op smalle randen, ramen, palen, roosters en buizen.

Art.-nr.	Draad	Draad Ø mm	Ø mm	mm			EAN
<b>ZB-doos</b>							
607830	grof	0,3	75	6		6	4 009316 078303
607930	grof	0,3	100	6		6	4 009316 079300

Art.-nr.	Draad	Draad Ø mm	Ø mm	mm			EAN
<b>Los in doos</b>							
607833	grof	0,3	75	6		Z20	4 009316 078334
607933	grof	0,3	100	6		Z10	4 009316 079331



**Schijfborstel, extra sterk, HSS-staaldraad, gevlochten**



Schijfborstel, HSS-staaldraad, gevlochten, voor extreem gebruik om te ontroesten, te ontbramen, lak te verwijderen, te ontslakken, te decaperen en lasnaden te reinigen, voor metaal en steen, ideaal voor werkzaamheden op smalle randen, ramen, palen, roosters en buizen.

Art.-nr.	Draad	Draad Ø mm	Ø mm	T mm			EAN
603030	grof	0,5	70	6		6	4 009316 030301

**Komborstel, HSS-staaldraad, golvend**

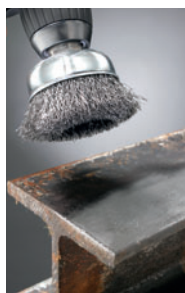

Komborstel, HSS-staaldraad, golvend, om roest, coatings en verf te verwijderen, schoon te maken, bekistingsplaten en gevels te reinigen, te decaperen, te ontbramen, op te ruwen en mat te maken, voor metaal en steen, ideaal voor werkzaamheden op middelgrote oppervlakken.

Art.-nr.	Draad	Draad Ø mm	Ø mm	T mm			EAN
<b>ZB-doos</b>							
606210	fijn	0,2	50	6		6	4 009316 062104
606230	grof	0,3	50	6		6	4 009316 062302
606310	fijn	0,2	75	6		6	4 009316 063101
606330	grof	0,3	75	6		6	4 009316 063309



Art.-nr.	Draad	Draad Ø mm	Ø mm	T mm			EAN
<b>Los in doos</b>							
606233	grof	0,3	50	6		Z25	4 009316 062333
606333	grof	0,3	75	6		Z15	4 009316 063330

**Komborstel, extra zwaar, HSS-staaldraad, golvend**



Komborstel, extra zwaar, HSS-staaldraad, golvend, om roest, coatings en verf te verwijderen, schoon te maken, bekistingsplaten en gevels te reinigen, te decaperen, te ontbramen, op te ruwen en mat te maken, voor metaal en steen, ideaal voor werkzaamheden op middelgrote en grote oppervlakken.

Art.-nr.	Draad	Draad Ø mm	Ø mm	T mm			EAN
<b>ZB-doos</b>							
602430	grof	0,35	75	6		6	4 009316 024300

## Borstels

### Komborstel, extra zwaar, HSS-staaldraad, golvend



Art.-nr.	Draad	Draad Ø mm	Ø mm	mm			EAN
<b>Los in doos</b>							
602433	grof	0,35	75	6		Z10	4 009316 024331



### Penseelborstel, HSS-staaldraad, golvend



Penseelborstel, HSS-staaldraad, golvend, om te ontroesten, te reinigen, coatings, verf en overtollig rubber te verwijderen, te decaperen, te ontbramen, op te ruwen en mat te maken, voor metaal en steen, ideaal voor werkzaamheden op moeilijk toegankelijke plekken en binnenvlakken, bijv. smeedijzeren poorten, roosters, sierhekken enz.

Art.-nr.	Draad	Draad Ø mm	Ø mm	mm			EAN
<b>ZB-doos</b>							
608030	grof	0,3	25	6		6	4 009316 080306



Art.-nr.	Draad	Draad Ø mm	Ø mm	mm			EAN
<b>Los in doos</b>							
608033	grof	0,3	25	6		Z24	4 009316 080337



### Houtstructuurborstel, HSS-staaldraad vermessingd



Houtstructuurborstel, HSS-staaldraad vermessingd, biedt corrosiebescherming, golvend, om te ontroesten, te reinigen, verf, hamerslag, verkorstingen en bramen te verwijderen, in het bijzonder geschikt om houten oppervlakken te structureren, voor metaal en hout, ideaal om te werken op randen, ramen, palen, roosters, buizen en middelgrote oppervlakken.

Art.-nr.	Arbeids-breedte	Draad Ø mm	Ø mm	mm			EAN
<b>ZB-doos</b>							
604030	40	0,27	80	8		3	4 009316 040300

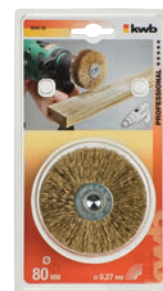

Art.-nr.	Arbeids-breedte	Draad Ø mm	Ø mm	mm			EAN
<b>Los in doos</b>							
604033	40	0,27	80	8		Z10	4 009316 040331



**Draadborstelset 4-delig, staaldraad, golvend**



Draadborstelset, 4-delig, 3 draadborstels, staaldraad, golvend, met klemschacht, om roest, coatings en verf te verwijderen, schoon te maken, bekistingsplaten en gevels te reinigen, te decaperen, te ontbramen, op te ruwen en mat te maken, voor metaal en steen.

Art.-nr.	Draad Ø mm	Inhoud			EAN
597500	0,3	1 schijfborstel Ø 75 mm, 1 komborstel Ø 50 mm, 1 penseelborstel Ø 15 mm, 1 klemschacht Ø 6 mm		6	4 009315 975009

**Draadborstelset 3-delig, HSS-staaldraad, golvend**



Draadborstelset, 3-delig, HSS-staaldraad, golvend, voor fijne bewerking, om te ontroesten, verf te verwijderen, te reinigen en mat te maken, voor gebruik in miniboormachinesystemen en flexibele assen, ideaal voor modelbouw.

Art.-nr.	Draad Ø mm	Inhoud			EAN
518000	0,1	1 schijfborstel Ø 22 mm, 1 komborstel Ø 18 mm, 1 penseelborstel Ø 5 mm		6	4 009315 180007

**Spiraalpijpenborstels, staaldraad, golvend**



Spiraalpijpenborstels, staaldraad, golvend, ideaal voor de bewerking van de binnenkant van pijpen en grotere gaten, om te ontroesten, verf te verwijderen, te reinigen, te decaperen, te ontbramen en mat te maken, voor de voorbereiding op soldeer- en laswerkzaamheden, voor metaal en steen.

Art.-nr.		Ø mm	Lengte totaal			EAN
<b>ZB-doos</b>						
599300	55	20	200		6	4 009315 993003
599400	55	26	200		6	4 009315 994000
599500	55	32	200		6	4 009315 995007
599600	55	38	200		6	4 009315 996004

Art.-nr.	Inhoud			EAN
<b>Los in doos</b>				
599922	5 x 13, 5 x 20, 5 x 26, 5 x 32, 4 x 38 mm		24	4 009315 999227



## Borstels

### Komborstel, messingdraad, golvend



Komborstel, messingdraad, biedt corrosiebescherming, golvend, voor fijne werkzaamheden, om te reinigen, verf te verwijderen, te polijsten en mat te maken, voor metaal en steen, ideaal voor werkzaamheden op middelgrote oppervlakken.

Art.-nr.	Draad	Draad Ø mm	Ø mm	mm			EAN
<b>ZB-doos</b>							
609110	fijn	0,2	50	6		4	4 009316 091104

Art.-nr.	Draad	Draad Ø mm	Ø mm	mm			EAN
<b>Los in doos</b>							
609113	fijn	0,2	50	6		Z20	4 009316 091135

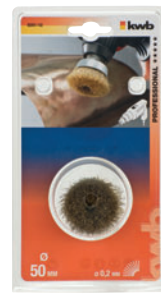

### Schijfborstel, messingdraad, golvend



Schijfborstel, messingdraad, biedt corrosiebescherming, golvend, voor fijne werkzaamheden, om te reinigen, verf te verwijderen, te polijsten en mat te maken, voor metaal en steen, ideaal voor werkzaamheden op smalle randen, ramen, roosters en buizen.

Art.-nr.	Draad	Draad Ø mm	Ø mm	mm			EAN
<b>ZB-doos</b>							
609310	fijn	0,2	75	6		4	4 009316 093108

Art.-nr.	Draad	Draad Ø mm	Ø mm	mm			EAN
<b>Los in doos</b>							
609313	fijn	0,2	75	6		Z15	4 009316 093139



### Schijfborstel, rvs-draad, roestvrij, golvend



Schijfborstel, rvs-draad, roestvrij, golvend, om te ontroesten, te reinigen, coatings en verf te verwijderen, te decaperen, te ontbramen, op te ruwen en mat te maken, voor rvs, metaal, hout en steen, voor werkzaamheden op smalle randen, ramen roosters, leuningen en buizen, ideaal voor gebruik buiten, laat geen roestende resten achter op het werkstuk.

Art.-nr.	Draad	Draad Ø mm	Ø mm	mm			EAN
609810	fijn	0,2	75	6		4	4 009316 098103
609830	grof	0,3	75	6		4	4 009316 098301



**Komborstel, schuurnylon**



Komborstel, schuurnylon, schuurkorrel van aluminiumoxide, elastisch, om te reinigen, verf, lak en aanloopkleuren bij lasnaden op rvs te verwijderen, voor hout, metaal en non-ferrometaal, ook geschikt voor het structureren van hout, voor werkzaamheden op middelgrote oppervlakken.

Art.-nr.	Draad	Ø mm	T mm			EAN
603230	grof	50	6		6	4 009316 032305
603330	grof	75	6		6	4 009316 033302

**Schijfborstel, schuurnylon**



Schijfborstel, schuurnylon, schuurkorrel van aluminiumoxide, elastisch, om te reinigen, verf, lak en aanloopkleuren bij lasnaden op rvs te verwijderen, voor hout, metaal en non-ferrometaal, ook geschikt voor het structureren van hout, voor werkzaamheden op smalle randen, ramen, roosters en ronde voorwerpen.

Art.-nr.	Draad	Ø mm	T mm			EAN
604310	fijn	75	6		6	4 009316 043106
604330	grof	75	6		6	4 009316 043301
604430	grof	100	6		6	4 009316 044308

**Waaierborstel, schuurnylon**



Waaierborstel, schuurnylon, schuurkorrel van aluminiumoxide, elastisch, om fijn te schuren, om te reinigen, verf, lak en aanloopkleuren bij lasnaden op rvs te verwijderen, voor hout, metaal en non-ferrometaal, ook geschikt voor het structureren van hout, voor werkzaamheden op vlakken.

Art.-nr.	Draad	Ø mm	Segmen-ten	T mm			EAN
604630	fijn	100	10	6		4	4 009316 046302



# SCHUREN EN POLIJSTEN

Schuurrollen

Schuurvellen

Schuurschijven

Schuurdriehoeken

Schuurvlies

Schuurstroken

Schuurgaas

Schuurbanden

Schuurpads

Staalwol

Handschuurblokken

Lamellenslijpers

Polijschijven en polijstvachten

## Schuren en polijsten



### De voordelen van de slijp- en polijstmiddelen

- Zeer uiteenlopende uitvoeringen (rollen, vellen, schijven, driehoeken, stroken, banden)
- Verschillende kwaliteiten en korrels voor de gewenste materialen (zie kwaliteiten)
- Lamellenslijpers voor de bewerking van vlakken en ronde voorwerpen
- Polijstschijven en -vachten voor het aanbrengen van polish en voor het polijsten van diverse materialen

## Kwaliteiten

### Korund, type HOUT & METAAL

Korund, bestrooid met aluminiumoxide, universeel bruikbaar voor het slijpen van hout en metaal, verf, lak, roest en plamuur. Korrels van 40 (grof) tot 180 (fijn).

**verkrijgbaar bij:**

schuurrollen, schuurvellen, schuurschijven, schuurdriehoeken, schuurstroken, schuurpads

### Waterbestendig, type LAK & AUTO

Bestrooid met siliciumcarbide, nat en droog bruikbaar, waterbestendig, bijzonder flexibel, verwijdert goed, lange levensduur, bijzonder fijne korrel voor professionele carrosseriewerkzaamheden en voor het afschuren van kunstharlak, lak, verf, glas, steen, kunststof en metaal. Korrels van 80 (grof) tot 1000 (extra fijn).

**verkrijgbaar bij:**

schuurvellen, schuurpads

### Finishing, type HOUT & LAK

Edel- en halfedelkorund, bestrooid met aluminiumoxide, speciaal voor hard- en zacht hout, kunstharlak, acryllak, verf, lak en kunststof. Korrels van 40 (grof) tot 320 (fijn).

**verkrijgbaar bij:**

schuurvellen

### Silberschliff, type HOUT & LAK

Silberschliff, korund, met aluminiumoxide bestrooid, stearaatcoating, voorkomt vroegtijdig dichtslibben van de korrel, speciaal voor hard- en zacht hout, kunstharlak, acryllak, verf, lak en kunststof. Korrels van 40 (grof) tot 240 (fijn).

**verkrijgbaar bij:**

schuurschijven, schuurdriehoeken

### Blauw keper, type METAAL & LACK

Korund, met aluminiumoxide bestrooid, dragermateriaal blauw keper, hoogwaardig schuurlijnen, flexibel, extreem scheurvast en sterk, universeel product voor de metaal- en staalbewerking, voor het verwijderen van roest, hamerslag, verf, lak en kunstharlak. Korrels van 40 (grof) tot 240 (fijn).

**verkrijgbaar bij:**

schuurvellen

### Schuurgas, type PLAMUUR & GIPSPLATEN

Schuurgas, vezelglasgas met kunsthar gebonden, korrel van siliciumcarbide, door de open maasstructuur is het schuurgas bijzonder geschikt voor het gladschuren van Rigips-werkzaamheden, geplamuurde oppervlakken, verf, kunstharlak, acryllak, roest en stoffen waarbij het fijne stof de afzuigaten verstoppt. Korrels van 120 (medium) en 180 (fijn).

**verkrijgbaar bij:**

schuurstroken



## kwb-info

### Altijd het passende schuurmiddel

Bij het grote aantal verschillende merken van slijpmachines is het soms niet eenvoudig het passende schuurmiddel te vinden. Onze machinewijzers zijn gesorteerd volgens fabrikant en geven een snel en eenvoudig overzicht van welk schuurmiddel bij uw machine past.

<b>Schuurschijven</b>	Pagina 160 - 161
<b>Schuurdriehoeken</b>	Pagina 168 - 169
<b>Schuurstroken</b>	Pagina 176 - 179
<b>Schuurbanden</b>	Pagina 186 - 188



## Flint, type HOUT & VERF

Kwartzand, voordelig en snel, standaard schuurpapier voor het schuren van hout, verf en plamuur. Korrels van 40 (grof) tot 240 (fijn).

verkrijgbaar bij:  
schuurvellen

## Schuurbanden, type HOUT & METAAL

Edelkorund, met aluminiumoxide bestrooid, gebonden met volledig synthetisch hars, dragermateriaal zwaar, zeer elastisch katoen, speciale verlijming, geschikt voor universele schuurtoepassingen. Korrels van 40 (grof) tot 240 (fijn). Verkrijgbaar bij:

verkrijgbaar bij:  
schuurbanden

## kwb-info

### Een kwestie van veiligheid



Met name bij werkzaamheden met elektrische schuurmachines zoals bijv. bandschuurmachines wordt stof en fijn stof geproduceerd. Beschermuw luchtwegen tegen dit, deels onzichtbare gevaar. kwb biedt hiervoor een omvangrijk assortiment veiligheidsmaskers, met en zonder ademventielen. Voor alle gangbare toepassingen in de voorgeschreven beschermingsklassen.

Alle informatie hierover vindt u in onze kwb-folder voor arbeidsveiligheid of op het internet op **www.kwb.eu**.





### Schuurmiddelrollen ★★★★★

Korund. Passend voor handschuurmachines, handschuurblokken en alle normale trilschuurmachines, want reeds voorgesneden op de gangbare breedten van 93 en 115 mm. Gewoon op de benodigde lengte snijden en voor het gewenste materiaal inzetten.

Pagina 156



### Schuurvellen ★★★★★

Korund, finishing, blauw keper, waterbestendig en flint. Passend voor handschuurmachines en handschuurblokken, bijzonder flexibel en handig, kunnen eenvoudig op de gewenste grootte worden gescheurd, gesneden of gevouwen. Verpakt per 50 vellen voor de verkoop van afzonderlijke vellen, met EAN-etiket.

Pagina 157 - 159

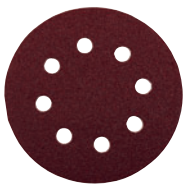

### Schuurschijven ★★★★★

Korund, Silberschliff, voor universele schuurtoepassingen

**voor alle gangbare boor- en accuboormachines:** niet-geperforeerd, met en zonder klittenbandsysteem QUICK-STICK

**voor alle gangbare excentrische schuurmachines:** geperforeerd met aanzuiggaten voor de interne stofafzuiging, met klittenbandsysteem QUICK-STICK

Pagina 162 - 167



### Schuurdriehoeken en speciale vormen ★★★★★

Korund en Silberschliff, passend voor alle gangbare delta-/driehoekschuurmachines en schuurmachines met speciale vormen, voor het schuren in hoeken en op oppervlakken, niet-geperforeerd of geperforeerd met aanzuiggaten voor de interne stofafzuiging. Met en zonder klittenbandsysteem QUICK-STICK.

Pagina 170 - 174



### Schuurvlies ★★★★★

Schuurkorrel van aluminiumoxide, voor gebruik op driehoekschuurmachines, voor het structureren en gladschuren van hout, voor het ontroesten van metaal en voor het slijpen of matteren van lakwerk. Met klittenbandsysteem QUICK-STICK.

Pagina 171 + 172



### Schuurstroken ★★★★★

Korund, voor gebruik op trilschuurmachines, kant-en-klaar op maat gesneden schuurstroken in verschillende maten, voor universele schuurtoepassingen, niet-geperforeerd of geperforeerd met aanzuiggaten voor de interne stofafzuiging. Met en zonder klittenbandsysteem QUICK-STICK.

Pagina 180 - 184



### Schuurgaas ★★★★★

Schuurgaas, vezelglasgaas met kunsthars gebonden, korrel van siliciumcarbide, geschikt voor gebruik op handschuurmachines, speciaal voor het gladschuren van plamuur, Rigips en Fermacell en voor het verwijderen van verf, kunstharslak, acryllak en roest.

Pagina 185



### Schuurbanden ★★★★★

Korund, voor gebruik op bandschuurmachines, schuurbanden met hoogwaardig, flexibel dragermateriaal, zeer nauwkeurige, schone bandloop in verschillende maten, geschikt voor universele schuurtoepassingen op grote oppervlakken.

Pagina 189 - 192

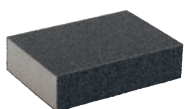

### Schuurpad ★★★★★

Bestrooid met siliciumcarbide of aluminiumoxide, drager van zeer flexibel polyurethaanschuim, kunstharsgebonden, droog en nat bruikbaar, bijzonder geschikt voor het schuren van gevormde oppervlakken, voor het verwijderen van roest en verf, voor reinigings- en schuurwerkzaamheden aan auto's en motorfietsen.

Pagina 193 - 194



### Staalwol ★★★★★

Staalwol, eensoortig kwaliteitsstaal, zeer scheurvast, elastisch, voor het polijsten, matteren, fijnschuren en reinigen van metaal en hout.

Pagina 195

## Programma overzicht schuren en polijsten



### Handschourblok

★★★★★

Voor gebruik met schuurstroken, met klemsysteem, geschikt voor universele schuurtoepassingen op kleinere oppervlakken. Ook verkrijgbaar als natuurproduct van kurk.

Pagina 196 - 197



### Vliesmopstift

★★★★★

Korund, combistift, bekleed met schuurpapier en schuurvlies, passend voor alle gangbare boor- en accuboormachines, voor de fijne bewerking van oppervlakken, voor het matteren en satineren van metalen, hout en kunststof, bijzonder geschikt voor vlakken en ronde voorwerpen.

Pagina 198



### Lamellenslijper

★★★★★

Korund, geschikt voor gebruik in alle (slag)boormachines, voor de oppervlaktebewerking van hout, metaal en kunststof, voor het afkanten, ontbramen, structureren, bijzonder geschikt voor vlakken en ronde voorwerpen. Ook verkrijgbaar als uitvoering met gelijkliggende fronten.

Pagina 198



### Polijschijven

★★★★★

Vilt, voor gebruik met een opspandoorn op gewone boormachines en accuboormachines, om politoer en was aan te brengen op hout, metaal, kunststof, marmer, glas, acryl en autolak. Met en zonder klittenbandsysteem QUICK-STICK.

Pagina 199



### Polijsvachten

★★★★★

Lamsvel, lamswol of vilt, voor gebruik met een opspandoorn op gewone boormachines en accuboormachines, voor het polijsten van hout, metaal, kunststof, marmer, glas, acryl en autolak. Met en zonder klittenbandsysteem QUICK-STICK.

Pagina 200 - 201

## kwb-info

### QUICK-STICK klittenbandsysteem

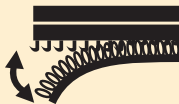

De klittenbandbekleding op de hechtpad is zelfklevend. De velours rugzijde aan het slijpmiddel zorgt voor een snelle, gereedschapsloze verwisseling.

#### QUICK-STICK is verkrijgbaar bij:

- Schuurschijven
- Schuurstroken
- Schuurdriehoeken
- Polijtschijven
- Schuurvlies
- Polijstvachten

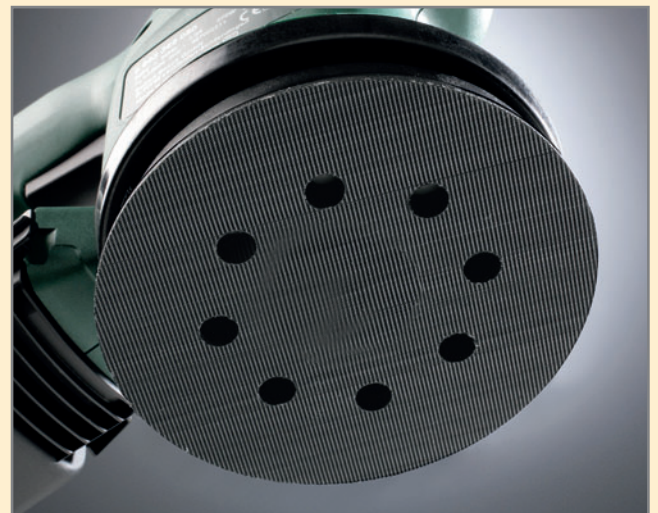

Schuurmiddelrollen, HOUT & METAAL, korund



Schuurmiddel op rollen, HOUT & METAAL, korund, met aluminiumoxide bestrooid, lengte 5 m, breedte 93 en 115 mm, geschikt voor alle gewoon verkrijgbare schuurmachines en voor handmatig schuren, voor het schuren van metaal, hout, verf, lak, plamuur, steen en kunststof.



Art.-nr.	Breedte	Korrel	Lengte			EAN
<b>HOUT &amp; METAAL, korund, 93 mm</b>						
817704	93 mm	40	5 m		1	4 0093 18 177042
817706	93 mm	60	5 m		1	4 0093 18 177066
817708	93 mm	80	5 m		1	4 0093 18 177080
817712	93 mm	120	5 m		1	4 0093 18 177127
817718	93 mm	180	5 m		1	4 0093 18 177189
817724	93 mm	240	5 m		1	4 0093 18 177240

Art.-nr.	Breedte	Korrel	Lengte			EAN
<b>HOUT &amp; METAAL, korund, 115 mm</b>						
817804	115 mm	40	5 m		1	4 0093 18 178049
817806	115 mm	60	5 m		1	4 0093 18 178063
817808	115 mm	80	5 m		1	4 0093 18 178087
817812	115 mm	120	5 m		1	4 0093 18 178124
817818	115 mm	180	5 m		1	4 0093 18 178186
817824	115 mm	240	5 m		1	4 0093 18 178247

**kwb-Info**

**Een kwestie van veiligheid**











Met name bij werkzaamheden met elektrische schuurmachines zoals band- en trilschuurmachines wordt stof en fijn stof geproduceerd. Bescherm uw luchtwegen tegen dit, deels onzichtbare gevaar. Hiervoor heeft kwb een omvangrijk assortiment veiligheidsmaskers, met en zonder ademventielen.

Voor alle gangbare toepassingen in de voorgeschreven beschermingsklassen.



## Schuurpapier HOUT & LAK, finishing













Art.-nr.	Inhoud	Korrel			EAN
<b>los</b>					
840040	50	40		Z50	
840060	50	60		Z50	
840080	50	80		Z50	
840100	50	100		Z50	
840120	50	120		Z50	
840150	50	150		Z50	
840180	50	180		Z50	
840240	50	240		Z50	
840320	50	320		Z50	

Schuurpapier, vellen 230 x 280 mm, HOUT & LAK, met aluminiumoxide bestrooid, versterkt papier, bijzonder geschikt voor kunstharlak, acryl-lak, lak, plamuur en verf op hout en metaal.



## Schuurpapier LAK & AUTO, waterbestendig



Art.-nr.	Inhoud	Korrel			EAN
<b>los</b>					
830080	50	80		Z50	
830120	50	120		Z50	
830180	50	180		Z50	
830240	50	240		Z50	
830320	50	320		Z50	
830400	50	400		Z50	
830600	50	600		Z50	
830800	50	800		Z50	
830980	50	1.000		Z50	

Schuurpapier, vellen 230 x 280 mm, LAK & AUTO, waterbestendig, bijzonder flexibel, verwijdert goed, lange levensduur, met siliciumcarbide bestrooid, bijzonder fijne korrel voor carrosseriewerkzaamheden en het afschuren van kunstharlak, lak, verf, glas, steen, kunststof en metaal.

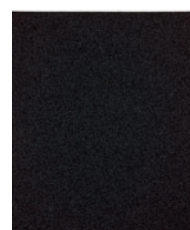

## Schuurpapier LAK & AUTO, waterbestendig, voordeelverpakking



Art.-nr.	Formaat	Inhoud			EAN
830960	5 x 180, 5 x 240, 5 x 400, 5 x 600	20		1	

Schuurpapier, vellen 230 x 280 mm, LAK & AUTO, waterbestendig, bijzonder flexibel, verwijdert goed, lange levensduur, met siliciumcarbide bestrooid, bijzonder fijne korrel voor carrosseriewerkzaamheden en het afschuren van kunstharlak, lak, verf, glas, steen, kunststof en metaal.

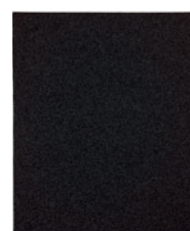











**Schuurlinnen METAAL & STAAL, blauw keper**



Schuurlinnen, vellen 230 x 280 mm, METAAL & STAAL, korund, met aluminiumoxide bestrooid, drager blauw keper, hoogwaardig schuurlinnen, flexibel, scheurvast en sterk, voor metaal- en staalbewerking, voor het verwijderen van roest, hamerslag, verf, lak en kunstharlak.











Art.-nr.	Inhoud	Korrel			EAN
<b>los</b>					
820040	25	40		Z25	
820060	25	60		Z25	
820080	25	80		Z25	
820100	25	100		Z25	
820120	25	120		Z25	
820150	25	150		Z25	
820180	25	180		Z25	
820240	25	240		Z25	

**Schuurpapier HOUT & METAAL, korund**



Schuurpapier, vellen 230 x 280 mm, HOUT & METAAL, korund met aluminiumoxide bestrooid, voor hout en metaal, voor het verwijderen van roest, verf, lak en plamuur.







Art.-nr.	Korrel			EAN
<b>los</b>				
810040	40		Z50	
810060	60		Z50	
810080	80		Z50	
810100	100		Z50	
810120	120		Z50	
810150	150		Z50	
810180	180		Z50	

**Schuurpapier HOUT & METAAL, korund, voordeelverpakking**



Schuurpapier, vellen 230 x 280 mm, HOUT & METAAL, korund met aluminiumoxide bestrooid, voor hout en metaal, voor het verwijderen van roest, verf, lak en plamuur.



Art.-nr.	Formaat	Inhoud			EAN
810960	5 x 60, 5 x 80, 5 x 150, 5 x 180	20		1	

## Schuurpapier HOUT & VERF, flint



Art.-nr.	Korrel			EAN
<b>los</b>				
800040	40		Z50	
800060	60		Z50	
800080	80		Z50	
800100	100		Z50	
800120	120		Z50	
800150	150		Z50	
800180	180		Z50	
800240	240		Z50	

Schuurpapier, vellen 230 x 280, HOUT & VERF, flint, voor hout, verf en plamuur.



## Schuurpapier HOUT & VERF, flint, voordeelverpakking



Art.-nr.	Formaat	Inhoud			EAN
800960	10 x 40, 20 x 100, 10 x 150, 10 x 180	50		1	

Schuurpapier, vellen 230 x 280, HOUT & VERF, flint, voor hout, verf en plamuur.



### kwb-Info



## Voor gladde oppervlakken en randen

Uitgescheurde randen en splinters kunnen met een kwb-handschuurblok van kurk moeiteloos worden weggeschuurd. Het natuurproduct is het klassieke materiaal voor handschuurblokken, die met alle soorten schuurpapier kunnen worden gebruikt. Bijzonder geschikt voor kleine oppervlakken.

Andere handschuurmiddelen vindt u op de pagina's 196 - 197 in onze catalogus.



... altijd de passende toebehoren voor uw machine!

QUICK-STICK schuurschijven, geperforeerd, rond						
	Ø 115 mm		Ø 125 mm		Ø 150 mm	
	Art.-nr.	Pagina	Art.-nr.	Pagina	Art.-nr.	Pagina
	4918- 5418-	164	4919- 5419- 4959-	164 - 165	4920- 5420- 4960-	165 - 166
Fabrikant/machinetype						
<b>AEG</b>						
EX 400, EX 450, EXE 400				x		
EXE 460 (125)				x		
EXE 460, ROS 150 E						x
<b>ALPHA TOOLS</b>						
ES 125 E				x		
<b>ATLAS - COPCO</b>						
TEX 150				x		
<b>BLACK &amp; DECKER</b>						
BD 190 / S / E / D, KA 198 GT				x		
KA 190 / S / EKA 191 EK,				x		
KA 280, 280 K, XTA 90EK				x		
<b>BOSCH</b>						
PEX 11 A / AE, PEX 115		x				
GEX 125 A / AC, GEX 125-1AE				x		
PEX 12 A/AE, PEX 125 A,				x		
PEX 125 AE, PEX 270 A / AE,				x		
PEX 220A, PEX 300 AE, 400 AE,				x		
GEX 150 AC / ACE, Turbo,						x
PEX 15 AE, PEX 420 AE						x
<b>DEWALT</b>						
DW 423, D26453				x		
DW 443, D26410						x
<b>EINHELL</b>						
EX 115		x				
BT-RS 420 E, RT-XS 28,				x		
BES 125				x		
<b>ELU</b>						
ES 55 E				x		
ES 56 E / EK						x
<b>ERGOTOOLS</b>						
E-ES 430 E				x		
<b>FEIN</b>						
MSF 636-1				x		
<b>FELISATTI</b>						
TP 521 / E / AS / EAS,						x
TP 522 AS / CE						x
<b>FERM</b>						
ESM 1007				x		
<b>FESTO</b>						
ES 125 / E				x		
<b>FLEX</b>						
XS 712 A				x		
X/XS 1107 VE						x
<b>HILTI</b>						
WFE 380, WFE 450 E						x
<b>HITACHI</b>						
TSV 13 Y, SV 13 YA / YB				x		
SAY 150 A						x
<b>KRESS</b>						
CPS 6115-1 / E		x				
CPS 6125-1 / E, HEX 1385 E				x		
HEX 6385 E / Set, 900 MPS				x		
900 HEX						x



## QUICK-STICK schuurschijven, geperforeerd, rond



Fabrikant/machinetype	Ø 115 mm		Ø 125 mm		Ø 150 mm	
	Art.-nr.	Pagina	Art.-nr.	Pagina	Art.-nr.	Pagina
	4918- 5418-	164	4919- 5419- 4959-	164 - 165	4920- 5420- 4960-	165 - 166
<b>MAC ALLISTER</b>						
MOS 450C				x		
<b>MAFELL</b>						
UT 150E						x
<b>MAKITA</b>						
BO 6040, 6030 (8 Löcher)						x
BO 5000, 5010, 5021, 5021 K				x		
<b>METABO</b>						
SXE 125, SXE 425, XL				x		
SXE 425 TURBOTEC				x		
FSX 200 INTEC, SXE 325 INTEC				x		
SXE 450 DUO, TURBOTEC						x
SXE 425 XL						x
<b>MILWAUKEE</b>						
PRS 125 E				x		
ROS 150 E						x
<b>PEUGEOT</b>						
PAE 115		x				
PRX 150 E						x
<b>RYOBI</b>						
ERO 2412VN, CRO 180M				x		
<b>SKIL</b>						
7415		x				
7400, 7402, 7425, 7430, 7435				x		
7440AA, 7460AA				x		
<b>STAYER</b>						
LRT 115		x				
LRT 150, RO 150						x
<b>WEGOMA</b>						
LRE 84 H				x		
RX 91 C, RT 118 N, RTE (1)46L						x
<b>WORX DIY</b>						
WX656, WX652				x		
<b>WORX PRO</b>						
WU651, WU652				x		x
WU654						

**Schuurschijven HOUT & METAAL, korund, Ø 125 mm , voordeelverpakking**



Schuurpapierschijven, Ø 125 mm, HOUT & METAAL, schijven met stergat, voor gebruik met de rubberen steunschijf kwb-artikel 483500 op gewone boormachines en accuboormachines, voor hout en metaal, voor het verwijderen van houtslip, verf, lak en plamuur.

Art.-nr.	Ø mm	Inhoud	Korrel			EAN
491150	125	40	12 x 50, 16 x 80, 12 x 120		1	4 009314 911503

**Schuurschijven HOUT & METAAL, korund, Ø 125 mm**



Schuurpapierschijven, Ø 125 mm, HOUT & METAAL, korund, met aluminiumoxide bevestigd, schijven met stergat, voor gebruik met de rubberen steunschijf kwb-artikel 483500 op gewone boormachines en accuboormachines, voor hout en metaal, voor het verwijderen van roest, verf, lak en plamuur.

Art.-nr.	Ø mm	Inhoud	Korrel			EAN
490210	125	4	120		12	4 009314 902105
490220	125	4	80		12	4 009314 902204
490230	125	4	50		12	4 009314 902303
491200	125	4	6 x 50, 8 x 80, 6 x 120		12	4 009314 912005

**Steunschijf, rubber**



Steunschijf, rubber, met spandoorn, voor gebruik met slijpschijven met stergat op alle normaal verkrijgbare boormachines en accuboormachines.

Art.-nr.	Ø mm				EAN
483500	125	8		6	4 009314 835007

**QUICK-STICK schuurschijven, HOUT & METAAL, edelkorund, Ø 115 mm**



Schuurschijven, Ø 115 mm, HOUT & METAAL, edelkorund, met aluminiumoxide bevestigd, gebonden met volledig synthetisch hars, versterkt dragermateriaal, met velours rug, voor excentrische schuurmachines, voor het schuren van metaal, hout, verf, lak, plamuur, steen en kunststof.







Art.-nr.	Ø mm	Inhoud	Korrel			EAN
487310	115	10	120		6	4 009314 873108
487320	115	10	80		6	4 009314 873207
487330	115	10	40		6	4 009314 873306
487300	115	10	3 x 40, 4 x 80, 3 x 120		6	4 009314 873009

## Schuurschijven

### QUICK-STICK schuurschijven, HOUT & METAAL, edelkorund, Ø 125 mm



Schuurschijven, Ø 125 mm, HOUT & METAAL, edelkorund, met aluminiumoxide bestrooid, gebonden met volledig synthetisch hars, versterkt dragermateriaal, met velours rug, voor excentrische schuurmachines, voor het schuren van metaal, hout, verf, lak, plamuur, steen en kunststof.







Art.-nr.	Ø mm	Inhoud	Korrel			EAN
488310	125	5	120		6	4 009314 883107
488320	125	5	80		6	4 009314 883206
488330	125	5	40		6	4 009314 883305
488300	125	6	2 x 40, 2 x 80, 2 x 120		6	4 009314 883008



### QUICK-STICK hechtsteunschijf



Hechtsteunschijf, met klittenband, zelfhechtend, voor schuurpaperschijven met velours rug, voor een snelle vervanging van het schuurpapier zonder gereedschap.



Art.-nr.	Ø mm	Schroefdraad	 mm			EAN
487000	115		8		6	4 009314 870008
487014	115	M14			6	4 009314 870145
488000	125		8		6	4 009314 880007
488014	125	M14			6	4 009314 880144



### QUICK-STICK kogelgewrichtschijvenset



Kogelgewrichtschijvenset, met 4 schuurschijven, vastzetbaar kogelgewricht, voor een optimale aanpassing van het schuurvlak aan het werkstuk, zorgt ook bij grotere oppervlakken voor trillingsarm schuren, met klittenband, zelfhechtend, voor schuurpaperschijven met velours rug, voor een snelle vervanging van het schuurpapier zonder gereedschap.

Art.-nr.	Ø mm	voor	Inhoud	 mm			EAN
482400	125	Voor schuur-schijven 488300, -310, -320, -330	incl. telkens 2 schuur-schijven Ø 125 mm, korrelgrootte 80 + 120	8		1	4 009314 824001



**QUICK-STICK schuurschijven, HOUT & METAAL, edelkorund, Ø 115 mm, geperforeerd**



Schuurschijven, Ø 115 mm, HOUT & METAAL, edelkorund, met aluminiumoxide bestrooid, gebonden met volledig synthetisch hars, versterkt dragermateriaal, met velours rug, geperforeerd, voor excentrische schuurmachines, voor het schuren van metaal, hout, verf, lak, plamuur, steen en kunststof.



Art.-nr.	Ø mm	Inhoud	Korrel			EAN
<b>ZB-doos</b>						
491804	115	5	40		6	4 009314 918045
491806	115	5	60		6	4 009314 918069
491808	115	5	80		6	4 009314 918083
491812	115	5	120		6	4 009314 918120
491818	115	5	180		6	4 009314 918182
491824	115	5	240		6	4 009314 918243
491800	115	5	2 x 40, 2 x 120, 1 x 240		6	4 009314 918006

Art.-nr.	Ø mm	Inhoud	Korrel			EAN
<b>voordeelverpakking</b>						
491870	115	25	9 x 60, 8 x 120, 8 x 180		1	4 009314 918700

Art.-nr.	Ø mm	Inhoud	Korrel			EAN
<b>Professionele voordeelverpakking, krimpfolie</b>						
541804	115	20	40		1	4 009315 418049
541806	115	20	60		1	4 009315 418063
541808	115	20	80		1	4 009315 418087
541812	115	20	120		1	4 009315 418124

**QUICK-STICK schuurschijven, HOUT & METAAL, edelkorund, Ø 125 mm, geperforeerd**



Schuurschijven, Ø 125 mm, HOUT & METAAL, edelkorund, met aluminiumoxide bestrooid, gebonden met volledig synthetisch hars, versterkt dragermateriaal, met velours rug, geperforeerd, voor excentrische schuurmachines, voor het schuren van metaal, hout, verf, lak, plamuur, steen en kunststof.



Art.-nr.	Ø mm	Inhoud	Korrel			EAN
<b>ZB-doos</b>						
491904	125	5	40		6	4 009314 919042
491906	125	5	60		6	4 009314 919066
491908	125	5	80		6	4 009314 919080
491912	125	5	120		6	4 009314 919127
491918	125	5	180		6	4 009314 919189
491924	125	5	240		6	4 009314 919240
491932	125	5	320		6	4 009314 919325
491900	125	5	2 x 40, 2 x 120, 1 x 240		6	4 009314 919004

## QUICK-STICK schuurschijven, HOUT & METAAL, edelkorund, Ø 125 mm, geperforeerd



Art.-nr.	Ø mm	Inhoud	Korrel			EAN
<b>Voordeelverpakking, krimpfolie</b>						
491970	125	25	9 x 60, 8 x 120, 8 x 180		1	4 009314 919707



Art.-nr.	Ø mm	Inhoud	Korrel			EAN
<b>Professionele voordeelverpakking, krimpfolie</b>						
541904	125	20	40		1	4 009315 419046
541906	125	20	60		1	4 009315 419060
541908	125	20	80		1	4 009315 419084
541912	125	20	120		1	4 009315 419121
541918	125	20	180		1	4 009315 419183
541924	125	20	240		1	4 009315 419244



## QUICK-STICK schuurschijven, HOUT & LAK, Silberschliff, Ø 125 mm, geperforeerd



Art.-nr.	Ø mm	Inhoud	Korrel			EAN
<b>ZB-doos</b>						
495904	125	5	40		6	4 009314 959048
495906	125	5	60		6	4 009314 959062
495908	125	5	80		6	4 009314 959086
495912	125	5	120		6	4 009314 959123

Schuurschijven, Ø 125 mm, HOUT & LAK, Silberschliff, korund, met aluminiumoxide bestrooid, stearaatcoating voorkomt vroegtijdig dichtslibben van de korrel, gebonden met volledig synthetisch hars, versterkt dragermateriaal, met velours rug, geperforeerd, voor excentrische schuurmachines, voor het schuren van hard- en zacht hout, kunstharslak, acryllak, verf en kunststof.



## QUICK-STICK schuurschijven, HOUT & METAAL, edelkorund, Ø 150 mm, geperforeerd



Art.-nr.	Ø mm	Inhoud	Korrel			EAN
<b>ZB-doos</b>						
492004	150	5	40		6	4 009314 920048
492006	150	5	60		6	4 009314 920062
492008	150	5	80		6	4 009314 920086
492012	150	5	120		6	4 009314 920123
492018	150	5	180		6	4 009314 920185
492024	150	5	240		6	4 009314 920246

Schuurschijven, Ø 150 mm, HOUT & METAAL, edelkorund, met aluminiumoxide bestrooid, gebonden met volledig synthetisch hars, versterkt dragermateriaal, met velours rug, geperforeerd, voor excentrische schuurmachines, voor het schuren van metaal, hout, verf, lak, plamuur, steen en kunststof.



**QUICK-STICK schuurschijven, HOUT & METAAL, edelkorund, Ø 125 mm, geperforeerd**

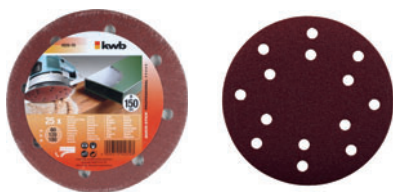

Art.-nr.	Ø mm	Inhoud	Korrel			EAN
<b>Voordeelverpakking, krimpfolie</b>						
492070	150	25	9 x 60, 8 x 120, 8 x 180		1	4 009314 920703

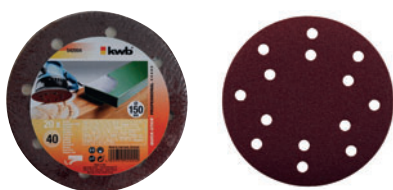

Art.-nr.	Ø mm	Inhoud	Korrel			EAN
<b>Professionele voordeelverpakking, krimpfolie</b>						
542004	150	20	40		1	4 009315 420042
542006	150	20	60		1	4 009315 420066
542008	150	20	80		1	4 009315 420080
542012	150	20	120		1	4 009315 420127

**QUICK-STICK schuurschijven, HOUT & VERF, Silberschliff, Ø 150 mm, geperforeerd**











Schuurschijven, Ø 150 mm, HOUT & LAK, Silberschliff, korund, met aluminiumoxide bestrooid, stearaatcoating voorkomt vroegtijdig dichtsliben van de korrel, gebonden met volledig synthetisch hars, versterkt dragermateriaal, met velours rug, geperforeerd, voor excentrische schuurmachines, voor het schuren van hard- en zacht hout, kunstharlak, acryllak, verf en kunststof.



Art.-nr.	Ø mm	Inhoud	Korrel			EAN
<b>ZB-doos</b>						
496004	150	5	40		6	4 009314 960044
496006	150	5	60		6	4 009314 960068
496008	150	5	80		6	4 009314 960082
496012	150	5	120		6	4 009314 960129

## QUICK-STICK hechtsteunschijf, geperforeerd, voor excentrische schuurmachine van Bosch



Art.-nr.	Ø mm	voor			EAN
480820	115	Bosch PEX 11 A/AE, PEX 115 A/AE, PEX 9,6 VA		2	
480830	115	Bosch PEX 11 A/AE, PEX 115 A/AE, PEX 9,6 VA		2	
480920	125	Bosch PEX 11 A/AE, PEX 115 A/AE, PEX 9,6 VA		2	

Hechtsteunschijf, geperforeerd, voor excentrische schuurmachines, met klittenband, zelfhechtend, voor schuurpapier met velours rug, voor een snelle vervanging van het schuurpapier zonder gereedschap.



## QUICK-STICK hechtsteunschijf, geperforeerd, voor excentrische schuurmachine van Bosch



Art.-nr.	Ø mm	voor			EAN
481820	125	Bosch PEX 270 A/AE		2	

Hechtsteunschijf, geperforeerd, voor excentrische schuurmachines, met klittenband, zelfhechtend, voor schuurpapier met velours rug, voor een snelle vervanging van het schuurpapier zonder gereedschap.

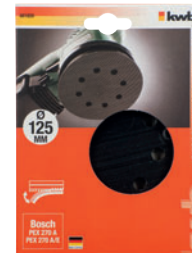
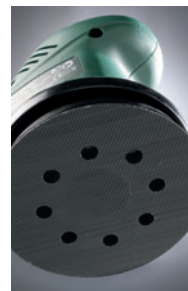

... altijd de passende toebehoren voor uw machine!



QUICK-STICK schuurdriehoeken  
en speciale vormen



Fabrikant/machinetype	96 mm		93 / 100 x 62 mm		93 / 100 x 62 mm (Schuurvlies)		105 mm	
	Art.-nr.	Pagina	Art.-nr.	Pagina	Art.-nr.	Pagina	Art.-nr.	Pagina
	4928- 5428- 4925- 4929-	170 - 171	4961- 4968-	171 - 172	4962-	172	4927-	172

<b>AEG</b>								
DSE 220, DSE 260								x
<b>ALPHA TOOLS</b>								
DS 180	x							
<b>BOSCH</b>								
GDA 280 E, PDA 100,	x							
PDA 120 E, PDA 240 E,	x							
PDA 180, PDA 180 E	x							
PMF 180 E	x							
PSM 160 A, PRIO, VENTARO			x			x		
PSM 80 A			x			x		
<b>BLACK &amp; DECKER</b>								
KA 511 EKA	x							
<b>CASALS</b>								
BLD 180, VLD 230	x							
<b>DEWALT</b>								
D 26430	x							
<b>EINHELL</b>								
BT-DS 180	x							
BDS 180	x							
RT-OS 13			x					
<b>ERGOTOOLS</b>								
E-DS 260	x							
<b>FERM</b>								
DSM 1009, OTM 1001	x							
OTM 1003	x							
<b>HITACHI</b>								
SV 12 SH	x							
<b>KRESS</b>								
CPS 6115-1 / E								x
CPS 6125-1 / E, HEX 1385 E								x
<b>MAKITA</b>								
BO 4561	x							
<b>METABO</b>								
DSE 130, DSE 170,	x							
DSE300 INTEC, DSE280 INTEC	x							
<b>MAC ALLISTER</b>								
MDS 180	x							
<b>SKIL</b>								
Octo 7208			x					
7207AA, 7208AA, 7250AA			x					
7110AA, 7115AA	x							
<b>WORX DIY</b>								
WX55DS	x							

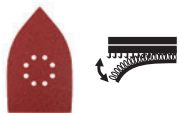

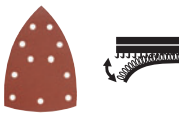
QUICK-STICK strijkijzervorm						
	107 x 175 mm geperforeerd		97 x 135 mm geperforeerd		100 x 147 mm geperforeerd	
Fabrikant/machinetype	Art.-nr.	Pagina	Art.-nr.	Pagina	Art.-nr.	Pagina
	4934-	173	4936-	173	4930-	174
<b>BOSCH</b>						
PSM 160 A, PRIO, VENTARO					x	
PSM 80 A					x	
<b>BLACK &amp; DECKER</b>						
KA 220 Multi, Multi E,	x					
KA 225, KA 250 K, KA 270	x					
KA 1000-Mouse			x			
KA 280, 280 K	x					
<b>EINHELL</b>						
RT-XS 28	x					
<b>FERM</b>						
PSM 1013, PSM 1012	x					
<b>METABO</b>						
FMS 200 INTEC					x	
<b>MAC ALLISTER</b>						
MDS 100			x			
<b>WORX DIY</b>						
WX646	x					

**QUICK-STICK schuurdriehoeken, HOUT & METAAL, edelkorund, 96 mm**



Schuurdriehoeken, 96 mm, HOUT & METAAL, edelkorund, met aluminiumoxide bestrooid, gebonden met volledig synthetisch hars, versterkt dragermateriaal, met velours rug, geperforeerd, voor delta-/driehoek-schuurmachines, voor het schuren van metaal, hout, verf, lak, plamuur, steen en kunststof.



Art.-nr.	Ø mm	Inhoud	Korrel			EAN
<b>ZB-doos</b>						
492804	96	5	40		6	4 009314 928044
492806	96	5	60		6	4 009314 928068
492808	96	5	80		6	4 009314 928082
492812	96	5	120		6	4 009314 928129
492818	96	5	180		6	4 009314 928181
492824	96	5	240		6	4 009314 928242
492832	96	5	320		6	4 009314 928327
492840	96	5	400		6	4 009314 928402
492800	96	5	2 x 40, 1 x 120, 2 x 240		6	4 009314 928006

Art.-nr.	Inhoud	Korrel			EAN
<b>Voordeelverpakking, krimpfolie</b>					
492870	20	8 x 60, 6 x 120, 6 x 180		1	4 009314 928709



Art.-nr.	Ø mm	Inhoud	Korrel			EAN
<b>Professionele voordeelverpakking, krimpfolie</b>						
542834	96	20	40		6	4 009315 428345
542836	96	20	60		6	4 009315 428369
542838	96	20	80		6	4 009315 428383
542842	96	20	120		6	4 009315 428420
542848	96	20	180		6	4 009315 428482



**QUICK-STICK schuurdriehoeken, HOUT & LAK, Silberschliff, 96 mm**



Schuurdriehoeken, 96 mm, HOUT & LAK, Silberschliff, korund, met aluminiumoxide bestrooid, steeraatcoating voorkomt vroegtijdig dichtslippen van de korrel, gebonden met volledig synthetisch hars, versterkt dragermateriaal, met velours rug, geperforeerd, voor deltaschuurmachines, voor het schuren van hard- en zacht hout, kunstharlak, acryllak, verf en kunststof.



Art.-nr.	Ø mm	Inhoud	Korrel			EAN
<b>ZB-doos</b>						
492504	96	5	40		6	4 009314 925043
492506	96	5	60		6	4 009314 925067
492508	96	5	80		6	4 009314 925081
492512	96	5	120		6	4 009314 925128

## QUICK-STICK schuurvlies, 96 mm



Art.-nr.	Ø mm	Inhoud	Korrel			EAN
<b>ZB-doos</b>						
492912	96	1	120		5	4 009314 929126
492928	93	1	280		5	4 009314 929288

Schuurvlies, 96 mm, zelfhechtend, met schuurkorrel van aluminiumoxide, gebonden met volledig synthetisch hars, met velours rug, voor gebruik op deltaschuurmachines, om metaal en lak mat te maken, houten vezels glad te maken en metaal te ontroesten.



## QUICK-STICK schuurdriehoeken, HOUT & METAAL, edelkorund, 100 x 62, 93 mm



Art.-nr.	Inhoud	Korrel			EAN
<b>ZB-doos</b>					
496104	5	40		6	4 009314 961041
496106	5	60		6	4 009314 961065
496108	5	80		6	4 009314 961089
496112	5	120		6	4 009314 961126
496118	5	180		6	4 009314 961188

Schuurdriehoeken, HOUT & METAAL, edelkorund, 100 x 62, 93 mm, met aluminiumoxide bestrooid, gebonden met volledig synthetisch hars, versterkt dragermateriaal, met velours rug, geperforeerd, voor delta-/driehoekschuurmachines, voor het schuren van metaal, hout, verf, lak, plamuur, steen en kunststof.



Art.-nr.	Inhoud	Korrel			EAN
<b>Voordeelverpakking, krimpfolie</b>					
496170	4	5 x 60, 5 x 120, 5 x 180		1	4 009314 961706



**QUICK-STICK schuurdriehoeken, HOUT & LAK, Silberschliff, 100 x 62, 93 mm**



Schuurdriehoeken, HOUT & LAK, Silberschliff, korund, 100 x 62, 93 mm, met aluminiumoxide bestrooid, steeraatcoating voorkomt vroegtijdig dichtslibben van de korrel, gebonden met volledig synthetisch hars, versterkt dragermateriaal, met velours rug, geperforeerd, voor deltaschuurmachines, voor het schuren van hard- en zacht hout, kunstharlak, acryllak, verf en kunststof.



Art.-nr.	Inhoud	Korrel			EAN
<b>ZB-doos</b>					
496804	5	40		6	4 009314 968040
496806	5	60		6	4 009314 968064
496808	5	80		6	4 009314 968088
496812	5	120		6	4 009314 968125
496818	5	180		6	4 009314 968187

**QUICK-STICK schuurvlies, 100 x 62, 93 mm**



Schuurvlies, 100 x 62, 93 mm, zelfhechtend, met schuurkorrel van aluminiumoxide, gebonden met volledig synthetisch hars, met velours rug, voor gebruik op deltaschuurmachines, om metaal en lak mat te maken, houten vezels glad te maken en metaal te ontroesten.



Art.-nr.	Inhoud	Korrel			EAN
<b>ZB-doos</b>					
496228	1	280		1	4 009314 962284

**QUICK-STICK schuurdriehoeken, HOUT & METAAL, edelkorund, 105 mm**



Schuurdriehoeken, 105 mm, HOUT & METAAL, edelkorund, met aluminiumoxide bestrooid, gebonden met volledig synthetisch hars, versterkt dragermateriaal, met velours rug, geperforeerd, voor delta-/driehoek-schuurmachines, voor het schuren van metaal, hout, verf, lak, plamuur, steen en kunststof.



Art.-nr.	Ø mm	Inhoud	Korrel			EAN
<b>ZB-doos</b>						
492704	105	5	40		6	4 009314 927047
492706	105	5	60		6	4 009314 927061
492708	105	5	80		6	4 009314 927085
492712	105	5	120		6	4 009314 927122



Art.-nr.	Ø mm	Inhoud	Korrel			EAN
<b>Voordeelverpakking, krimpfolie</b>						
492770	105	20	8 x 60, 6 x 120, 6 x 180		1	4 009314 927702

## QUICK-STICK schuurdriehoeken, HOUT & METAAL, edelkorund, 107 x 175 mm



Art.-nr.	Inhoud	Korrel			EAN
<b>ZB-manchet</b>					
493404	5	40		6	4 009314 934045
493406	5	60		6	4 009314 934069
493408	5	80		6	4 009314 934083
493412	5	120		6	4 009314 934120
493418	5	180		6	4 009314 934182
493424	5	240		6	4 009314 934243
493400	5	2 x 40, 2 x 120, 1 x 240		6	4 009314 934007

Art.-nr.	Inhoud	Korrel			EAN
<b>Voordeelverpakking, krimpfolie</b>					
493470	4	5 x 60, 5 x 120, 5 x 180		1	4 009314 934700

Schuurdriehoeken, HOUT & METAAL, edelkorund, 107 x 175 mm, met aluminiumoxide bestrooid, gebonden met volledig synthetisch hars, versterkt dragermateriaal, met velours rug, geperforeerd, voor delta-/driehoekschuurmachines, voor het schuren van metaal, hout, verf, lak, plamuur, steen en kunststof.



## QUICK-STICK schuurdriehoeken, HOUT & METAAL, edelkorund, 96 x 136 mm



Art.-nr.	Inhoud	Korrel			EAN
<b>ZB-manchet</b>					
493608	5	80		6	4 009314 936087
493612	5	120		6	4 009314 936124
493618	5	180		6	4 009314 936186
493624	5	240		6	4 009314 936247
493600	5	2 x 80, 1 x 120, 2 x 240		6	4 009314 936001

Art.-nr.	Inhoud	Korrel			EAN
<b>Voordeelverpakking, krimpfolie</b>					
493670	4	6 x 80, 5 x 120, 4 x 240		1	4 009314 936704

Schuurdriehoeken, HOUT & METAAL, edelkorund, 96 x 136 mm, met aluminiumoxide bestrooid, gebonden met volledig synthetisch hars, versterkt dragermateriaal, met velours rug, geperforeerd, voor delta-/driehoekschuurmachines, voor het schuren van metaal, hout, verf, lak, plamuur, steen en kunststof.



**QUICK-STICK schuurdriehoeken, HOUT & METAAL, edelkorund, 100 x 147 mm**



Schuurdriehoeken, HOUT & METAAL, edelkorund, 100 x 147 mm, met aluminiumoxide bestrooid, gebonden met volledig synthetisch hars, versterkt dragermateriaal, met velours rug, geperforeerd, voor delta-/driehoekschuurmachines, voor het schuren van metaal, hout, verf, lak, plamuur, steen en kunststof.

Art.-nr.	Inhoud	Korrel			EAN
<b>Voordeelverpakking, krimpfolie</b>					
493070	4	5 x 60, 5 x 120, 5 x 180		6	4 009314 930702



**QUICK-STICK hechtsteunschijf, geperforeerd, voor deltaschuurmachine**



Voor Bosch-deltaschuurmachine PDA 100, PDA 120 E. Hechtsteunschijf, geperforeerd, voor deltaschuurmachines, met klittenband, zelfhechtend, voor schuurpapier met velours rug, voor een snelle vervanging van het schuurpapier zonder gereedschap.

Art.-nr.	Afmeting			EAN
493100	93 x 93 x 93 mm		1	4 009314 931006



**QUICK-STICK hechtsteunschijf, geperforeerd, voor deltaschuurmachine**







Voor Bosch-deltaschuurmachine PDA 180, PDA 240, GDA 280. Hechtsteunschijf, geperforeerd, voor deltaschuurmachines, met klittenband, zelfhechtend, voor schuurpapier met velours rug, voor een snelle vervanging van het schuurpapier zonder gereedschap.

Art.-nr.	Afmeting			EAN
495100	93 x 93 x 93 mm		1	4 009314 951004









... altijd de passende toebehoren voor uw machine!





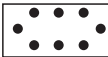

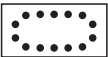





Schuurstroken standaard										
Afmeting: breedte x lengte	93 x 230 mm		115 x 280 mm		geperforeerd type A 93 x 230 mm	geperforeerd type B 93 x 230 mm	geperforeerd 115 x 280 mm			
Fabrikant/machinetype	Art.-nr.	Pagina	Art.-nr.	Pagina	Art.-nr.	Pagina	Art.-nr.	Pagina	Art.-nr.	Pagina
	815-	180	812-	180	8181-	181	8182-	181	8187-	182
<b>UNIVERSEEL</b>										
Met kleminrichting zonder stofafzuiging	x		x							
<b>AEG</b>										
VS 130, VSE 130, VS 230	x				x					
VSS 260 / E	x				x					
VS 14, VS 20, VSE 20, VSS 20									x	
VSSE 20, VS 250, VSE 250									x	
VSS 280, VSSE 280									x	
<b>ALPHA TOOLS</b>										
ASS 280									x	
<b>ATLAS COPCO</b>										
VS 230, VSE 230,			x				x			
VSS 260, VSSE 260			x				x			
VS 280 E, VS 280 SE									x	
VSE 230, VSS 20 E									x	
<b>BLACK &amp; DECKER</b>										
DN 41 A, DN 41 AE, BD 175,	x				x					
BD 180, BD 180 E, KA 300	x				x					
KA 185, KA 185 E	x				x					
BD 175, BD 180 E, DN 41 AE,			x				x			
DN 180 E, KA 186 E, KA 196,			x				x			
KC 185 E, KC 273, KC 962,			x				x			
CD 400, VB 135 B			x				x			
SR 400, PL 52										
BD 273, DN 49, DN 273,									x	
DN 41 AE, DN 180 E, KC 962,									x	
P 63-03, P 63-04, P 63-05,									x	
KA 180 E, KA 274 EKA,									x	
SR 410 E, VB 135 A, VB 250 E									x	
KA 273									x	
KA 310, KA 320 EKA	x				x					
<b>BOSCH</b>										
GSS 23 AE, GSS 230 A/ AE			x				x			
PSS 23 A/AE, PSS 240 A/AE			x				x			
GSS 23 AE, PSS 230			x				x			
GSS 9,6 V, GSS 140 A										
GSS 28 A/AE, GSS 280 A/AE,									x	
PSS 28 AE, PSS 280 AE									x	
PSS 300 AE									x	
GSS 28 A									x	
<b>CASALS</b>										
BLR 170, YLR 210			x				x			
BLR 250									x	
LN 216, LR 228									x	
<b>DEWALT</b>										
DW 411, D26411										
D26420, D26421									x	
D26422, D26423			x				x			
<b>EINHELL</b>										
EST 170			x				x			
RT-OS 30									x	
BT-OS 280 E									x	
BT-RS 420 E, RT-XS 28										
<b>ELU</b>										
MVS 47, MVS 91, MVS 94									x	
VS 280, VSE/VSSE 280									x	
VS 41, VS 71									x	















# Schuurstroken standaard

Schuurstroken standaard										
Afmeting: breedte x lengte	93 x 230 mm		115 x 280 mm		geperforeerd type A 93 x 230 mm	geperforeerd type B 93 x 230 mm	geperforeerd 115 x 280 mm			
Fabrikant/machinetype	Art.-nr.	Pagina	Art.-nr.	Pagina	Art.-nr.	Pagina	Art.-nr.	Pagina	Art.-nr.	Pagina
	815-	180	812-	180	8181-	181	8182-	181	8187-	182
<b>ERGOTOOLS</b>										
E-VS 280										x
<b>FEIN</b>										
MSS 641 a, MSS 641 b										x
<b>FESTO</b>										
RS 3 SFE, RS 3E SFE										
LRB-IAS, LRB-T1, RS 1, RS 2,										x
RS 2 E, RTB, RTB-E, RTB-EA,										x
RTR-S2, RTT-S2, RTS, 2 RB-IAS										x
<b>HILTI</b>										
WFO 280										x
<b>HITACHI</b>										
SV 12 SD, SV 12 V										x
<b>KRESS</b>										
CRS 6175 E, CRS 6175 ES										x
CRS 6165 A, 300 RSE										x
<b>MAKITA</b>										
9036		x						x		
BO 3711, BO 3700		x						x		
BO 4553, BO 4554, BO 4555										
BO 4556, BO 4558										
BO 9046, BO 4901, BO 4900 V										x
<b>METABO</b>										
SR 356, SR 4350				x				x		
SR 226, SRE 227, SR 10-23				x				x		
SR 20-23				x				x		
SR 180 INTEC, SRE 357				x				x		
SR 328, 4321, SRE 329, 359										x
<b>PEUGEOT</b>										
DN 180, DN 180 E, KA 185 A,		x						x		
KA 185 E, KC 962, VB 135 A		x						x		
10 TV I AS		x						x		
PV 240 A, TV 4102				x				x		
BP 22 E										x
<b>RYOBI</b>										
NS 401, NS 801, S 35				x				x		
S 605 D, EOS 2410										
ESS 1890C, ESS 2590V				x				x		
ESS 3215V										x
<b>SKIL</b>										
7310, 7315, 7350, 7385,				x				x		
7300, 7320, 7330, 7340, 7360,				x				x		
7365, 7390, 7395				x				x		
7351AA, 7366AA				x				x		
7576 U, 7312AA										
7380AA, 7300										x
666										x
<b>WORX PRO</b>										
WU645										
WU644, WU641								x		

... altijd de passende toebehoren voor uw machine!

Schuurstroken QUICK-STICK	 		 		 		 		 					
	Art.-nr.	Pagina	Art.-nr.	Pagina	Art.-nr.	Pagina	Art.-nr.	Pagina	Art.-nr.	Pagina	Art.-nr.	Pagina	Art.-nr.	Pagina
<b>afmeting: breedte x lengte</b>	geperforeerd 80 x 133 mm		geperforeerd 93 x 185 mm		geperforeerd 93 x 187 mm		geperforeerd 100 x 115 mm		geperforeerd 115 x 230 mm		Schuurgaas 93 x 230 mm		Schuurgaas 115 x 280 mm	
<b>Fabrikant/machinetype</b>	<b>8184-</b>	182	<b>8183-</b>	183	<b>8179-</b>	183	<b>8180-</b>	184	<b>8189-</b>	184	<b>851-</b>	185	<b>854-</b>	185
<b>UNIVERSEEL</b>														
Met kleminrichting zonder stofafzuiging												x		x
<b>AEG</b>														
VS / E 230, VS / E 260			x											
FS 2	x													
<b>ATLAS COPCO</b>														
VS 230, VSE 230, VSS 260, VSSE 260			x											
VS 11	x													
VSS 22			x											
VS 280 E, VS 280 SE, VSE 230, VSS 20 E									x					
<b>BLACK &amp; DECKER</b>														
P 63-01	x													
KA 175, KA 186, KA 186 E			x		x									
KA 273									x					
KA 310, KA 320 EKA					x									
<b>BOSCH</b>														
GSS 23 AE, GSS 230 A/ AE, PSS 23 A/AE, PSS 240 A/AE			x											
PSS 180 A, PSS 200 A, PSS 250 AE			x											
GSS 28 A/AE, GSS 280 A/AE, PSS 28 AE, PSS 280 AE									x					
PSS 300 AE									x					
PSS 289 AE									x					
GSS 16 A	x													
<b>CASALS</b>														
KLAR 210			x											
BLR 250									x					
VLR 300									x					
<b>DEWALT</b>														
D26420, D26421										x				
D26422, D26423			x											
<b>EINHELL</b>														
EST 170			x											
LRS 93 G/M, RS 3/E			x											
ERU 270									x					
RT-OS 30									x					
<b>ELU</b>														
VS 41, VS 71									x					
<b>FELISATTI</b>														
TP 31 E	x													
<b>FERM</b>														
PSM 1024			x											
<b>FESTO</b>														
RS 4, RS 4 E, RS 4 STF/ESTF	x													
RS 400 (-Plus)	x													
RS 3 E, RS 3 SFE			x											
RS 1 STF, RS 2 STF, RS 2 E									x					
<b>FESTOOL</b>														
RTS 400	x													
RS 200									x					
RS 300, LRS 93			x											

# Schuurstroken QUICK-STICK

Schuurstroken QUICK-STICK	 		 		 		 		 					
	Afmeting: breedte x lengte	geperforeerd 80 x 133 mm		geperforeerd 93 x 185 mm		geperforeerd 93 x 187 mm		geperforeerd 100 x 115 mm		geperforeerd 115 x 230 mm		Schuurgas 93 x 230 mm		Schuurgas 115 x 280 mm
Fabrikant/machinetype	Art.-nr.	Pagina	Art.-nr.	Pagina	Art.-nr.	Pagina	Art.-nr.	Pagina	Art.-nr.	Pagina	Art.-nr.	Pagina	Art.-nr.	Pagina
<b>HITACHI</b>														
SV 8 SA		x												
FS 10 SB				x										
SV 12 SF, 12 SG, 12 SH								x						
SV 12 SD, SV 12 V										x				
<b>HOLZ HER</b>														
2241										x				
<b>KRESS</b>														
CRS 6165 A, 300 RSE										x				
CRS 6175 EA										x				
<b>MAC ALLISTER</b>														
MSS 260						x								
MSS 300										x				
<b>MAFELL</b>														
UK 115 / U 115E										x				
<b>MAKITA</b>														
9036				x										
BO 4556, BO 4554, BO 4561								x						
BO 4554, BO 4561								x						
9045 B, 9045 N										x				
BO 9046, BO 4901, BO 4900 V										x				
<b>METABO</b>														
SR 356, SR 4350				x										
SR 357				x										
SR 10-23 INTEC, SR 20-23				x										
FSR 200 INTEC								x						
SR 358, SRE 4351										x				
<b>MILWAUKEE</b>														
POS 13		x												
<b>PEUGEOT</b>														
PV 240 A, TV 4102				x										
TV 4003, TV 4103										x				
<b>RYOBI</b>														
ESS 1890C, ESS 2590V				x										
S 33 K				x										
NS 6200, NS 6300 A										x				
ESS 3215V										x				
<b>SKIL</b>														
7300, 7320, 7330, 7340, 7360				x										
7365, 7390, 7395				x										
7351AA, 7366AA				x										
7270, 7300 S				x										
666										x				
<b>WEGOMA</b>														
LR 184 H				x										
<b>WORX DIY</b>														
WX637										x				
WX639, WX640, WX26FS						x								
<b>WORX PRO</b>														
WU644, WU641				x										
<b>WEGOMA</b>														
LR 184 H				x										

**Schuurstroken, HOUT & METAAL, korund, 93 x 230 mm**



Schuurstroken, HOUT & METAAL, 93 x 230 mm, korund met aluminiumoxide bestrooid, voor hout en metaal, voor het verwijderen van roest, verf, lak en plamuur. Voor schuurmachines.



Art.-nr.	Inhoud	Korrel			EAN
<b>ZB-doos</b>					
815040	10	40		5	4 009318 150403
815080	10	80		10	4 009318 150809
815120	10	120		10	4 009318 151202
815180	10	180		10	4 009318 151806
815240	10	240		10	4 009318 152407

Art.-nr.	Inhoud	Korrel			EAN
<b>Voordeelverpakking, krimpfolie</b>					
815888	50	12 x 60, 12 x 80, 13 x 120, 13 x 180		1	4 009318 158881

**Schuurstroken, HOUT & METAAL, korund, 115 x 280 mm**



Schuurstroken, HOUT & METAAL, 115 x 280 mm, korund met aluminiumoxide bestrooid, voor hout en metaal, voor het verwijderen van roest, verf, lak en plamuur. Voor schuurmachines.













Art.-nr.	Inhoud	Korrel			EAN
<b>ZB-doos</b>					
812040	10	40		5	4 009318 120406
812080	10	80		10	4 009318 120802
812120	10	120		10	4 009318 121205
812240	10	240		10	4 009318 122400

Art.-nr.	Inhoud	Korrel			EAN
<b>Voordeelverpakking, krimpfolie</b>					
812999	50	12 x 60, 12 x 80, 13 x 120, 13 x 180		1	4 009318 129997



## Schuurstroken, HOUT & METAAL, korund, 93 x 230 mm, geperforeerd, TYPE A



Art.-nr.	Inhoud	Korrel			EAN
<b>ZB-doos</b>					
818104	10	40		10	
818108	10	80		10	
818112	10	120		10	
818124	10	240		10	

Schuurstroken, HOUT & METAAL, 93 x 230 mm, korund, universeel geperforeerd, met aluminiumoxide bestrooid, voor hout en metaal, voor het verwijderen van roest, verf, lak en plamuur. Voor schuurmachines met afzuigstelsysteem.













Art.-nr.	Inhoud	Korrel			EAN
<b>voordeelverpakking</b>					
818188	30	7 x 40, 7 x 80, 8 x 120, 8 x 180		1	





## Schuurstroken, HOUT & METAAL, korund, 93 x 230 mm, geperforeerd, TYPE B



Art.-nr.	Inhoud	Korrel			EAN
<b>ZB-doos</b>					
818204	10	40		10	
818208	10	80		10	
818212	10	120		10	
818224	10	240		10	

Schuurstroken, HOUT & METAAL, 93 x 230 mm, korund, universeel geperforeerd, met aluminiumoxide bestrooid, voor hout en metaal, voor het verwijderen van roest, verf, lak en plamuur. Voor schuurmachines met afzuigstelsysteem.



Art.-nr.	Inhoud	Korrel			EAN
<b>voordeelverpakking</b>					
818288	30	7 x 40, 7 x 80, 8 x 120, 8 x 180		1	



... altijd de passende toebehoren voor uw machine!

**Schuurstroken, HOUT & METAAL, korund, 115 x 280 mm, geperforeerd**



Schuurstroken, HOUT & METAAL, 115 x 280 mm, korund, universeel geperforeerd, met aluminiumoxide bestrooid, voor hout en metaal, voor het verwijderen van roest, verf, lak en plamuur. Voor schuurmachines met afzuigstelsel.



Art.-nr.	Inhoud	Korrel			EAN
<b>ZB-doos</b>					
818704	10	40		5	4 009318 187041
818708	10	80		5	4 009318 187089
818712	10	120		5	4 009318 187126
818724	10	240		5	4 009318 187249

Art.-nr.	Inhoud	Korrel			EAN
<b>voordeelverpakking</b>					
818788	30	7 x 40, 7 x 80, 8 x 120, 8 x 180		1	4 009318 187881

**QUICK-STICK schuurstroken, HOUT & METAAL, edelkorund, 80 x 133 mm**









Schuurstroken, HOUT & METAAL, 80 x 133 mm, edelkorund, met aluminiumoxide bestrooid, gebonden met volledig synthetisch hars, versterkt dragermateriaal, met velours rug, geperforeerd. Voor schuurmachines met hecht draagplaat en afzuigstelsel. Voor het schuren van metaal, hout, verf, lak, plamuur, steen en kunststof.



Art.-nr.	Inhoud	Korrel			EAN
<b>ZB-doos</b>					
818404	5	40		5	4 009318 184040
818408	5	80		5	4 009318 184088
818412	5	120		5	4 009318 184125
818418	5	180		5	4 009318 184187



## QUICK-STICK schuurstroken, HOUT & METAAL, edelkorund, 93 x 185 mm

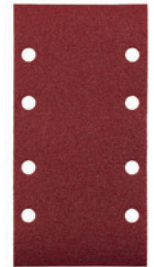

Art.-nr.	Inhoud	Korrel			EAN
<b>ZB-doos</b>					
818304	5	40		5	4 009318 183043
818308	5	80		5	4 009318 183081
818312	5	120		5	4 009318 183128
818318	5	180		5	4 009318 183180
818324	5	240		5	4 009318 183241

Schuurstroken, HOUT & METAAL, 93 x 185 mm, edelkorund, met aluminiumoxide bestrooid, gebonden met volledig synthetisch hars, versterkt dragermateriaal, met velours rug, geperforeerd. Voor schuurmachines met hecht draagplaat en afzuigstelsysteem. Voor het schuren van metaal, hout, verf, lak, plamuur, steen en kunststof.



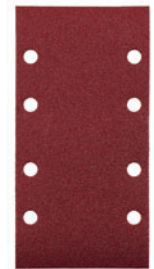

Art.-nr.	Inhoud	Korrel			EAN
<b>Voordeelverpakking, krimpfolie</b>					
818388	4	3 x 40, 4 x 60, 4 x 80, 4 x 120		1	4 009318 183883



## QUICK-STICK schuurstroken, HOUT & METAAL, edelkorund, 93 x 186 mm



Art.-nr.	Inhoud	Korrel			EAN
817980	10	3 x 40, 4 x 80, 3 x 240		5	4 009318 179800

Schuurstroken, HOUT & METAAL, 93 x 186 mm, edelkorund, met aluminiumoxide bestrooid, gebonden met volledig synthetisch hars, versterkt dragermateriaal, met velours rug, geperforeerd. Voor schuurmachines met hecht draagplaat en afzuigstelsysteem. Voor het schuren van metaal, hout, verf, lak, plamuur, steen en kunststof.

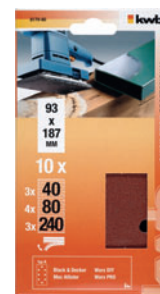

**QUICK-STICK schuurstroken, HOUT & METAAL, edelkorund, 115 x 100 mm**



Schuurstroken, HOUT & METAAL, 115 x 100 mm, edelkorund, met aluminiumoxide bestrooid, gebonden met volledig synthetisch hars, versterkt dragermateriaal, met velours rug, geperforeerd. Voor schuurmachines met hecht draagplaat en afzuigstelsysteem. Voor het schuren van metaal, hout, verf, lak, plamuur, steen en kunststof.



Art.-nr.	Inhoud	Korrel			EAN
<b>ZB-doos</b>					
818004	5	40		5	4 009318 180042
818008	5	80		5	4 009318 180080
818012	5	120		5	4 009318 180127
818018	5	180		5	4 009318 180189
818024	5	240		5	4 009318 180240

**QUICK-STICK schuurstroken, HOUT & METAAL, edelkorund, 115 x 230 mm**



Schuurstroken, HOUT & METAAL, 115 x 230 mm, edelkorund, met aluminiumoxide bestrooid, gebonden met volledig synthetisch hars, versterkt dragermateriaal, met velours rug, geperforeerd. Voor schuurmachines met hecht draagplaat en afzuigstelsysteem. Voor het schuren van metaal, hout, verf, lak, plamuur, steen en kunststof.



Art.-nr.	Inhoud	Korrel			EAN
<b>ZB-doos</b>					
818904	5	40		5	4 009318 189045
818908	5	80		5	4 009318 189083
818912	5	120		5	4 009318 189120
818918	5	180		5	4 009318 189182
818924	5	240		5	4 009318 189243

**kwb-Info**

**Een kwestie van veiligheid**

Met name bij werkzaamheden met elektrische schuurmachines zoals band- en trilschuurmachines wordt stof en fijn stof geproduceerd. Bescherm uw luchtwegen tegen dit, deels onzichtbare gevaar. Hiervoor heeft kwb een omvangrijk assortiment veiligheidsmaskers, met en zonder ademventielen.







Voor alle gangbare toepassingen in de voorgeschreven beschermingsklassen.









## Schuurgas PLAMUUR & GIPSPLATEN, 93 x 230 mm



Art.-nr.	Inhoud	Korrel			EAN
<b>ZB-doos</b>					
851120	2	120		5	
851180	2	180		5	

Schuurgas, vezelglasgas met kunsthars gebonden, korrel van siliciumcarbide, voor het gladschuren van plamuur en het verwijderen van verf, kunstharlak, acryllak en roest Slibt niet dicht.





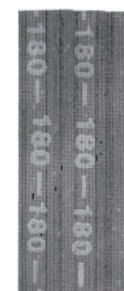



Art.-nr.	Inhoud	Korrel			EAN
<b>voordeelverpakking</b>					
851820	5	120		5	
851880	5	180		5	







## Schuurgas PLAMUUR & GIPSPLATEN, 115 x 280 mm



Art.-nr.	Inhoud	Korrel			EAN
<b>ZB-doos</b>					
854120	2	120		5	
854180	2	180		5	

Schuurgas, vezelglasgas met kunsthars gebonden, korrel van siliciumcarbide, voor het gladschuren van plamuur en het verwijderen van verf, kunstharlak, acryllak en roest Slibt niet dicht.



Art.-nr.	Inhoud	Korrel			EAN
<b>voordeelverpakking</b>					
854820	5	120		5	
854880	5	180		5	



Schuurbanden 40 x 303 mm - 75 x 533 mm

Afmeting: breedte x lengte	40 x 303 mm		60 x 400 mm		65 x 410 mm		75 x 457 mm		75 x 480 mm		75 x 510 mm		75 x 533 mm	
	Art.-nr.	Pagina	Art.-nr.	Pagina	Art.-nr.	Pagina	Art.-nr.	Pagina	Art.-nr.	Pagina	Art.-nr.	Pagina	Art.-nr.	Pagina
Fabrikant/machinetype	9107-	189	9110-	189	9114-	189	9119-	189	9121-	190	9123-	190	9125-	190
	9107-	189	9110-	189	9114-	189	9119-	190	9121-	190	9123-	190	9125-	191
<b>AEG</b>														
HBS 65, HBSE 65					x									
HBSE 75 S, HBSE 600,													x	
RBSE 75 AE													x	
<b>ALPHA TOOLS</b>														
BBS 720							x							
<b>ATLAS COPCO</b>														
HBSE 75, MBSE 705													x	
<b>BLACK &amp; DECKER</b>														
BD 83/E, DN 83/E, KA 83/E					x									
BS 650					x									
KA 85, KA 85 E, KA 86							x							
DN 85 / E, BD 85, P 61-03											x			
SR 500 E, KA 83											x			
BD 75 / E, KA 75 / E, KA 88													x	
XT 80Ek													x	
<b>BOSCH</b>														
Vario Schl. GVS 350 AE	x													
PBS 60, PBS 60 E			x											
PBS 7 A, PBS 7AE							x							
PBS 75, E, PBS 75 A/ AE													x	
0270, GBS 75 A/AE													x	
<b>CASALS</b>														
LC 75													x	
<b>DEWALT</b>														
DW 430, 431, 432, 433													x	
<b>DURO</b>														
DBS 600							x							
<b>EINHELL</b>														
BT-BS 850 E, BBS 720							x							
RT-BS 75													x	
<b>ELU</b>														
MHB 157 / E, MHB 158 / E									x					
<b>ERGOTOOLS</b>														
E-BS 800													x	
<b>FELISATTI</b>														
TP 411													x	
<b>FERM</b>														
BSM 1021, BSM 1022													x	
<b>FESTO</b>														
BS 75, BS 75 E/-Plus, BS 75 E-Set													x	
<b>HITACHI</b>														
SB 75, SB 8V2													x	
<b>HOLZ HER</b>														
2405 Derby, 2406					x									
2288, 2410, 2411, E, 2420, E													x	
<b>KRESS</b>														
CBS 6800, E, 600 HTEB					x									
<b>MAC ALLISTER</b>														
MBS 800													x	
<b>MAKITA</b>														
9910, 9911							x							
9900 B, 9901, 9902, 9903													x	

## Schuurbanden 40 x 303 mm - 75 x 533 mm

Afmeting: breedte x lengte	40 x 303 mm		60 x 400 mm		65 x 410 mm		75 x 457 mm		75 x 480 mm		75 x 510 mm		75 x 533 mm	
	Art.-nr.	Pagina	Art.-nr.	Pagina	Art.-nr.	Pagina	Art.-nr.	Pagina	Art.-nr.	Pagina	Art.-nr.	Pagina	Art.-nr.	Pagina
Fabrikant/machinetype	<b>9107-</b>	189	<b>9110-</b>	189	<b>9114-</b>	189	<b>9119-</b>	189	<b>9121-</b>	190	<b>9123-</b>	190	<b>9125-</b>	190
							<b>9019-</b>	190					<b>9025-</b>	191
<b>METABO</b>														
Ba 0665, Ba E 0666						x								
BAE 0775, BAE 0875, BAE 75														x
BAE 0876 Signal, BaE 1075														x
<b>PARKSIDE</b>														
PBS 900 A1														x
<b>PEUGEOT</b>														
PB 600, PB 75, PB 600/H								x						
TPB 7500								x						
PAB 75														x
<b>RYOBI</b>														
B-7075, B 7076, EBS 8021V														x
B 850F / K7, BE 321SF														x
EBS 9576														x
<b>SKIL</b>														
1100, 1200 / H, 1205 / H								x						
1210AA, 7600 A, 7610, 7620								x						
7630, 7640, 7650, 7675 S								x						
594 U, 599 U, 7640, 7650														x
<b>STAYER</b>														
LEN 75														x
<b>TOOLSON</b>														
Pro-BS 850 E														x
<b>TOOLTEC</b>														
700 Watt								x						
<b>WORX DIY</b>														
WX660								x						
WX661														x
<b>WORX PRO</b>														
WU661								x						
WU663														x

... altijd de passende toebehoren voor uw machine!

Schuurbanden 75 x 610 mm - 105 x 620 mm + 13 x 457 mm

Afmeting: breedte x lengte	75 x 610 mm		100 x 560 mm		100 x 610 mm		105 x 620 mm		13 x 457 mm	
	Art.-nr.	Pagina	Art.-nr.	Pagina	Art.-nr.	Pagina	Art.-nr.	Pagina	Art.-nr.	Pagina
Fabrikant/machinetype	<b>9130-</b>	191	<b>9144-</b>	191	<b>9145-</b>	191	<b>9147-</b>	191	<b>9105-</b>	192
<b>AEG</b>										
HBS 100, HBSE 100,			x							
BBS 1100, BBSE 1100			x							
HBS 2-110, HBS 10 / E							x			
<b>ATLAS COPCO</b>										
BBS 100 / E			x							
BBS 100 / E							x			
<b>BLACK &amp; DECKER</b>										
Powerfile BD 280, BD 282 E,									x	
BD 290, BD 292 E, DN 280,									x	
DN 282 E, KA 290, KA 292 E									x	
KA 293 E, KA 900 E									x	
<b>BOSCH</b>										
1270, GBS 100 A/AE							x			
<b>CASALS</b>										
LC 110							x			
<b>DEWALT</b>										
DW 650, 650 E			x							
<b>EINHELL</b>										
BT-BS 1200						x				
<b>ELU</b>										
MHB 90 / E / K			x							
<b>FESTO</b>										
BUZ-S, BU 25			x							
BS 105/E(-Set)							x			
<b>FESTOOL</b>										
BS 105							x			
<b>HITACHI</b>										
9924 DB	x									
SB 10 T, 10 V, 10 S2, 10 V2						x				
SB 110							x			
<b>HOLZ HER</b>										
2422, 2423, E, 2424, E							x			
<b>MAKITA</b>										
9924, 9920	x									
9401 / 02 / 03 / 04, 9924 DB						x				
9402, 9924 DB							x			
<b>MAFELL</b>										
ZUB 110							x			
<b>METABO</b>										
Ba 6100							x			
<b>RYOBI</b>										
B-7100	x									
HB-422, HABE-422, B 422,			x							
BE 422 K 5			x							
B-7200 A, EBS 1310VF, BE 424						x				
<b>SKIL</b>										
1400 H, 1405 H										
<b>WEGOMA</b>										
LB 31 EA						x				

## Schuurbanden, HOUT & METAAL, edelkorund



Art.-nr.	Inhoud	Korrel			EAN
<b>40 x 303 mm</b>					
910704	3	40		3	4 009319 107048
910706	3	60		3	4 009319 107062
910708	3	80		3	4 009319 107086
910715	3	150		3	4 009319 107154

Schuurbanden, edelkorund met aluminiumoxide bestrooid, gebonden met volledig synthetisch hars, drager van zwaar, zeer elastisch katoen, speciale verlijming, ratel- en fladdervrije verbinding.



## Schuurbanden, HOUT & METAAL, edelkorund



Art.-nr.	Inhoud	Korrel			EAN
<b>60 x 400 mm</b>					
911004	3	40		3	4 009319 110048
911006	3	60		3	4 009319 110062
911008	3	80		3	4 009319 110086
911010	3	100		3	4 009319 110109
911015	3	150		3	4 009319 110154

Schuurbanden, edelkorund met aluminiumoxide bestrooid, gebonden met volledig synthetisch hars, drager van zwaar, zeer elastisch katoen, speciale verlijming, ratel- en fladdervrije verbinding.



Art.-nr.	Inhoud	Korrel			EAN
<b>65 x 410 mm</b>					
911404	3	40		3	4 009319 114046
911406	3	60		3	4 009319 114060
911408	3	80		3	4 009319 114084
911410	3	100		3	4 009319 114107
911415	3	150		3	4 009319 114152



Art.-nr.	Inhoud	Korrel			EAN
<b>75 x 457 mm</b>					
911904	3	40		3	4 009319 119041
911906	3	60		3	4 009319 119065
911908	3	80		3	4 009319 119089
911910	3	100		3	4 009319 119102
911912	3	120		3	4 009319 119126
911915	3	150		3	4 009319 119157



Schuurbanden, HOUT & METAAL, edelkorund



Art.-nr.	Inhoud	Korrel			EAN
<b>75 x 457 mm, professionele voordeelverpakking, krimpfolie</b>					
901904	10	40		1	4 009319 019044
901906	10	60		1	4 009319 019068
901908	10	80		1	4 009319 019082
901910	10	100		1	4 009319 019105



Art.-nr.	Inhoud	Korrel			EAN
<b>75 x 480 mm</b>					
912115	3	150		3	4 009319 121150



Art.-nr.	Inhoud	Korrel			EAN
<b>75 x 510 (508) mm</b>					
912304	3	40		3	4 009319 123048
912306	3	60		3	4 009319 123062
912308	3	80		3	4 009319 123086
912310	3	100		3	4 009319 123109
912312	3	120		3	4 009319 123123
912315	3	150		3	4 009319 123154



Art.-nr.	Inhoud	Korrel			EAN
<b>75 x 533 mm</b>					
912502	3	24		3	4 009319 125028
912504	3	40		3	4 009319 125042
912506	3	60		3	4 009319 125066
912508	3	80		3	4 009319 125080
912510	3	100		3	4 009319 125103
912512	3	120		3	4 009319 125127
912515	3	150		3	4 009319 125158

## Schuurbanden, HOUT & METAAL, edelkorund



Art.-nr.	Inhoud	Korrel			EAN
<b>75 x 533 mm, professionele voordeelverpakking, krimpfolie</b>					
902502	5	24		1	4 009319 025027
902504	10	40		1	4 009319 025045
902506	10	60		1	4 009319 025069
902508	10	80		1	4 009319 025083
902510	10	100		1	4 009319 025106
902515	10	150		1	4 009319 025151

Art.-nr.	Inhoud	Korrel			EAN
<b>75 x 610 mm</b>					
913015	3	150		3	4 009319 130152

Art.-nr.	Inhoud	Korrel			EAN
<b>100 x 560 mm</b>					
914404	3	40		3	4 009319 144043
914406	3	60		3	4 009319 144067
914408	3	80		3	4 009319 144081
914410	3	100		3	4 009319 144104
914415	3	150		3	4 009319 144159

Art.-nr.	Inhoud	Korrel			EAN
<b>100 x 610 mm</b>					
914504	3	40		3	4 009319 145040
914506	3	60		3	4 009319 145064
914508	3	80		3	4 009319 145088
914510	3	100		3	4 009319 145101
914515	3	150		3	4 009319 145156

Art.-nr.	Inhoud	Korrel			EAN
<b>105 x 620 mm</b>					
914704	3	40		3	4 009319 147044
914706	3	60		3	4 009319 147068
914708	3	80		3	4 009319 147082
914710	3	100		3	4 009319 147105
914712	3	120		3	4 009319 147129
914715	3	150		3	4 009319 147150



... altijd de passende toebehoren voor uw machine!

**Schuurbanden, HOUT & METAAL, edelkorund, 13 x 457 mm**



Schuurbanden, edelkorund met aluminiumoxide bestrooid, gebonden met volledig synthetisch hars, drager van zwaar, zeer elastisch katoen, speciale verlijming, ratel- en fladdervrije verbinding.



Art.-nr.	Inhoud	Korrel			EAN
<b>13 x 457 mm</b>					
910504	3	40		3	4 009319 105044
910506	3	60		3	4 009319 105068
910508	3	80		3	4 009319 105082
910510	3	100		3	4 009319 105105

**kwb-Info**

**Een kwestie van veiligheid**



Ons oog is een van onze belangrijkste zintuigen en moet dus bij alle werkzaamheden worden beschermd.

Daarom heeft kwb voor alle gangbare binnen- en buitentoeepassingen, zoals boren, frezen, slijpen en lassen, een hoogwaardig, ook voor bril dragers geschikt assortiment veiligheidsbrillen samengesteld.

Alle informatie hierover vindt u in onze kwb-folder over arbeidsveiligheid of op internet onder [www.kwb.eu](http://www.kwb.eu)





## Schuurpad, HOUT & METAAL



Art.-nr.	Inhoud	Korrel			EAN
<b>ZB-manchet</b>					
089010	3	fijn		6	4 009310 890109
089020	3	Medium		6	4 009310 890208
089030	3	grof		6	4 009310 890307
089000	3	1 x fijn, 1 x medium, 1 x grof		6	4 009310 890000

Schuurpad, aan 2 kanten met siliciumcarbide bestrooid, 125 x 100 x 10 mm, drager van zeer flexibel polyurethaanschuim, kunstharsgebonden, droog en nat bruikbaar. Het schuurstof kan worden uitgewassen. Lange levensduur, bijzonder geschikt voor het schuren van gevormde oppervlakken. Voor het verwijderen van roest en verf. Voor het reinigen en schuren van kunstharlak en acryllak als voorbereiding op een nieuwe laag.



## Schuurpad UNI-SCHLEIFIX HOUT & METAAL



Art.-nr.	Korrel			EAN
<b>Los in presentatiedoos</b>				
089120	Fijn, medium		20	4 009310 891205
089130	Medium, grof		20	4 009310 891304

Schuurpad, aan 4 kanten met aluminiumoxide bestrooid, 100 x 70 x 26 mm, korund, enkelvoudige korrel aan één smalle en één brede zijkant, dubbele korrel op de pad zelf, drager van zeer flexibel polyurethaanschuim, kunstharsgebonden, droog en nat bruikbaar. Het schuurstof kan worden uitgewassen. Lange levensduur, bijzonder geschikt voor het schuren van gevormde oppervlakken. Voor het verwijderen van roest en verf. Voor het reinigen en schuren van kunstharlak en acryllak als voorbereiding op een nieuwe laag. Geschikt voor het schuren van ramen en deuren als voorbereiding op een nieuwe verflaag.



Art.-nr.	Korrel			EAN
<b>los</b>				
089111	fijn		50	4 009310 891113
089121	Fijn, medium		50	4 009310 891212
089131	Medium, grof		50	4 009310 891311



**Schuurpad AUTO-SCHLEIFIX, LAK & AUTO, waterbestendig**



Schuurpad, aan 4 kanten bestrooid, 100 x 70 x 26 mm, siliciumcarbide, enkelvoudige korrel aan één smalle en één brede zijkant, dubbele korrel op de pad zelf, drager van zeer flexibel polyurethaanschuim, kunstharsgebonden, droog en nat bruikbaar. Het schuurstof kan worden uitgewassen. Lange levensduur, bijzonder geschikt voor het schuren van gevormde oppervlakken. Voor het verwijderen van roest en verf. Voor schuurwerkzaamheden op auto's en motorfietsen.



Art.-nr.	Korrel			EAN
<b>Los in presentatiedoos</b>				
089210	fijn		20	4 009310 892103
089220	Fijn, medium		20	4 009310 892202
089230	Medium, grof		20	4 009310 892301

Art.-nr.	Korrel			EAN
<b>los</b>				
089211	fijn		50	4 009310 892110
089221	Fijn, medium		50	4 009310 892219
089231	Medium, grof		50	4 009310 892318

**Reinigingsschijf**



Reinigingsschijf, grof, om te schuren met het boven- of het zijvlak, flexibel, nylon filamenten met schuurpartikels van siliciumcarbide, voor het reinigen en ontroesten van plaatstaal, non-ferrometalen, kunststof, steen en hout, voor gebruik met een boormachine, kan met precieze rand werken.

Art.-nr.	Ø mm	mm			EAN
479100	100	8		6	4 009314 791006

**Reinigingsschijvenassortiment, 20-delig**



Assortiment reinigingschijven, 20-delig, in presentatiedoos, grof, om te schuren met het boven- of het zijvlak, flexibel, nylon filamenten met schuurpartikels van siliciumcarbide, voor het reinigen en ontroesten van plaatstaal, non-ferrometalen, kunststof, steen en hout, voor gebruik met een boormachine.

Art.-nr.	Ø mm	Lengte			EAN
479192	100	8		Z18	4 009314 791921

## Staalwol, rolletjes



Art.-nr.	Inhoud	Korrel	Nummer			EAN
089700	6 rolletjes	fijn	00		6	4 009310 897009

Staalwol, eensoortig staal, zeer scheurvast, elastisch. Voor het polijsten, matten, fijschuren en reinigen van metaal en hout.



## Staalwol, kussentje



Art.-nr.	Inhoud	Korrel	Nummer			EAN
089400	2 kussentjes	fijn	00		6	4 009310 894008
089410	2 kussentjes	Medium	01		6	4 009310 894107
089430	2 kussentjes	grof	03		6	4 009310 894305

Staalwol, eensoortig staal, zeer scheurvast, elastisch. Voor het polijsten, matten, fijschuren en reinigen van metaal en hout.



## Staalwol



Art.-nr.	Inhoud	Korrel	Nummer			EAN
089500	200 g	fijn	00		1	4 009310 895005
089510	200 g	Medium	01		1	4 009310 895104
089530	200 g	grof	03		1	4 009310 895302
089560	200 g	Extra fijn	000		1	4 009310 895609

Staalwol, eensoortig staal, zeer scheurvast, elastisch. Voor het polijsten, matten, fijschuren en reinigen van metaal en hout.



## Staalwol, rvs



Art.-nr.	Inhoud	Korrel	Nummer			EAN
089600	150 g	Extra fijn	000		1	4 009310 896002
089610	150 g	Medium	01		1	4 009310 896101

Staalwol, eensoortig staal, roestvrij, zeer scheurvast, elastisch. Ideaal voor werkzaamheden buiten, laat geen roestende partikels achter op de behandelde oppervlakken.



**Professioneel handschuurblok, met veerklemmen**



Handschuurblok voor gebruik met schuurstroken 93 x 230 mm. Met kleminrichting, ergonomisch gevormd handvlak voor moeiteloos werken, sponsrubberen arbeidsvlak van 4 mm aan de onderkant.



Art.-nr.	Afmeting			EAN
<b>los</b>				
485121	165 x 87 mm		10	4 009314 851212

**PROFESIONELE handschuurset, met 50 schuurstroken 93 x 230 mm**



Handschuurblok voor gebruik met schuurstroken 93 x 230 mm. Met kleminrichting, met 50 schuurstroken. Korund, met aluminiumoxide bestrooid, voor hout en metaal, voor het verwijderen van roest, verf, lak en plamuur. Ook bruikbaar op een schuurmachine.



Art.-nr.	Inhoud	Korrel			EAN
485170	1 handschuurblok 4851, schuurstroken 93 x 230 mm	12 x 60, 12 x 80, 13 x 120, 13 x 180		1	4 009314 851700

**Handschuurblok, rubber**









Handschuurblok van rubber, ideaal voor alle handschuurwerkzaamheden, door zijn ronde vorm ligt het schuurblok optimaal in de hand, dankzij zijn spits toelopende uiteinden kunnen ook afgeronde ribben en randen perfect worden geschuurd, met de inwendige spijkerklemming wordt het schuurpapier optimaal vastgehouden.



Art.-nr.	Afmeting			EAN
<b>ZB-kaart</b>				
485000	130 x 70 mm		6	4 009314 850000

## Handschourblok, kurk







Art.-nr.	Afmeting			EAN
<b>ZB-kaart</b>				
484800	40 x 60 x 100 mm		12	
484900	40 x 80 x 120 mm		12	

Handschourblok van kurk, een natuurproduct, de klassieker onder de handschourblokken, geschikt voor alle soorten schuurpapier om kleinere oppervlakken te schuren.



## Handschourset met 2 x schuurgaas







Art.-nr.	Inhoud			EAN
484200	Handschourblok, schuurgaas 1 x 120, 1 x 180		1	

Handschourblok met kleminrichting voor alle schuurstroken van 93 x 230 mm. Schuurgaas, vezelglasgaas met kunsthars gebonden, korrel van siliciumcarbide, voor het gladschuren van plamuur en het verwijderen van verf, kunstharslak, acryllak en roest. Slibt niet dicht.



## Handschourset met 12 x schuurgaas, VOORDEELVERPAKKING



Art.-nr.	Inhoud			EAN
484250	Handschourblok, schuurgaas 1 x 120, 1 x 180, voordeelverpakking 10 x 120		1	

Handschourblok met kleminrichting voor alle schuurstroken van 93 x 230 mm. Schuurgaas, vezelglasgaas met kunsthars gebonden, korrel van siliciumcarbide, voor het gladschuren van plamuur en het verwijderen van verf, kunstharslak, acryllak en roest. Slibt niet dicht.



Vliesmopstift



Vliesmopstift, combistift, bekleed met schuurpapier en schuurvlies, voor bijzonder fijn schuren van metaal, hout en kunststof, bijzonder goed geschikt voor oppervlakken en ronde voorwerpen.

Art.-nr.	Korrel	Kop-Ø x hoogte	T mm			EAN
088310	150 - fijn	50 x 25	6		2	4 009310 883101
088330	60 - grof	50 x 25	6		2	4 009310 883309
088410	150 - fijn	75 x 45	6		2	4 009310 884108
088430	60 - grof	75 x 45	6		2	4 009310 884306

Lamellenslijper, korund, vlakke kop



Lamellenslijper, korund, vlakke kop, slijpt met het boven- en het zijvlak, voor hout, metaal en kunststof, bijzonder geschikt voor vlakken en ronde voorwerpen.

Art.-nr.	Korrel	Kop-Ø x hoogte	T mm			EAN
088010	120 - fijn	60 x 40	6		6	4 009310 880100
088030	60 - grof	60 x 40	6		6	4 009310 880308

Lamellenslijper, korund



Lamellenslijper, korund, voor hout, metaal en kunststof, bijzonder geschikt voor vlakken en ronde voorwerpen.

Art.-nr.	Korrel	Kop-Ø x hoogte	T mm			EAN
088110	120 - fijn	50 x 20	6		6	4 009310 881107
088130	60 - grof	50 x 20	6		6	4 009310 881305

## Polijstmiddelen

### QUICK-STICK polijstspons, zelfhechtend



Polijstspons, moltopreen, met velours rug, voor gebruik op hechtsteunschijven met klittenband, m politoer en was aan te brengen op hout, metaal, kunststof, marmer, glas, acryl en autolak.

Art.-nr.	Ø mm	Voor steunschijven			EAN
486600	125	115 - 125 mm		1	4 009314 866001



### QUICK-STICK vilten polijstschiif, zelfhechtend



Vilten polijstschiif, met velours rug, voor gebruik op hechtsteunschijven met klittenband, m politoer en was aan te brengen op hout, metaal, kunststof, marmer, glas, acryl en autolak.

Art.-nr.	Ø mm	Voor steunschijven			EAN
486000	125	115 - 125 mm		6	4 009314 860009



### QUICK-STICK vilten polijstschiif, zelfhechtend, voor deltaschuurmachine



Vilten polijstschiif, met velours rug, voor gebruik op hechtsteunschijven met klittenband, m politoer en was aan te brengen op hout, metaal, kunststof, marmer, glas, acryl en autolak.

Art.-nr.	Ø mm	Voor steunschijven			EAN
493000	96	96 mm		5	4 009314 930009



### Vilten polijstschiif



Vilten polijstschiif voor gebruik met een opspandoorn op gewone boormachines en accu-boormachines, om politoer en was aan te brengen op hout, metaal, kunststof, marmer, glas, acryl en autolak.

Art.-nr.	Ø mm	Ø binnen			EAN
511300	75	13 mm		6	4 009315 113005



**Lappenschijf**



Lappenschijf, voor gebruik met een opspandoorn op gewone boormachines en accuboormachines, voor het polijsten van hout, metaal, kunststof, marmer, glas, acryl en autolak.

Art.-nr.	Ø mm	Ø binnen			EAN
517300	75	13 mm		6	4 009315 173009
517400	100	13 mm		6	4 009315 174006

**Polijstvlacht**



Polijstvlacht, echt lamsvel, met spankoord voor de bevestiging op normaal verkrijgbare steunschijven, voor het polijsten van hout, metaal, kunststof, marmer, glas, acryl en autolak.

Art.-nr.	Ø mm	Voor steunschijven			EAN
485500	135	4835		10	4 009314 855005

**Polijstvlacht**



Polijstvlacht, geweven lamswol, met spankoord voor de bevestiging op normaal verkrijgbare steunschijven, voor het polijsten van hout, metaal, kunststof, marmer, glas, acryl en autolak.

Art.-nr.	Ø mm	Voor steunschijven			EAN
484500	135	4835		10	4 009314 845006

**QUICK-STICK polijstvlacht, zelfhechtend**



Polijstvlacht, echt lamsvel, met velours rug, voor gebruik op steunschijven met klittenband, voor het polijsten van hout, metaal, kunststof, marmer, glas, acryl en autolak.

Art.-nr.	Ø mm	Voor steunschijven			EAN
484600	125	115 - 125 mm		6	4 009314 846003

**QUICK-STICK polijstvlacht, zelfhechtend**



Polijstvlacht, geweven lamswol, met velours rug, voor gebruik op steunschijven met klittenband, voor het polijsten van hout, metaal, kunststof, marmer, glas, acryl en autolak.

Art.-nr.	Ø mm	Voor steunschijven			EAN
484700	135	115 - 125 mm		6	4 009314 847000



## Polijstmiddelen

### Polijstset speciaal, 5-delig



Polijstset speciaal, 5-delig, voor hoogglanspolijstwerkzaamheden, voor de bewerking van hout, metaal, kunststof, marmer, glas, acryl en autolak, voor gebruik met gewone boormachines en accuboormachines.

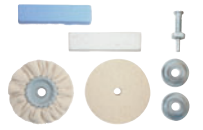

Art.-nr.	Inhoud			EAN
485200	1 x polijstpasta wit, 1 x hoogglanspolijst-pasta blauw, 1 vilten schijf, 1 lappenschijf, 1 opspandoorn		3	4 009314 852004



### Polijstset standaard, 6-delig



Polijstset standaard, 6-delig, voor polijstwerkzaamheden, voor de bewerking van hout, metaal, kunststof, marmer, glas, acryl en autolak, voor gebruik met gewone boormachines en accuboormachines.

Art.-nr.	Inhoud			EAN
485300	1 x voorpolijstpasta bruin, 1 x polijstpasta wit, 1 sisalborstel, 2 lappenschijven, 1 opspandoorn		3	4 009314 853001



### Polijstpastaset, 2-delig



Polijstpastaset, 2-delig, voorpolijstpasta en polijstpasta.





Art.-nr.	Inhoud			EAN
485420	1 x polijstpasta wit, 1 x hoogglanspolijst-pasta blauw		5	4 009314 854206



### Opspandoorn



Opspandoorn, linkse schroefdraad, met 2 flensschijven en spanmoer, voor het opspannen van keramische schijven, vilten polijstschijven, lappenschijven, sisalborstels en polijstschijven op alle normaal verkrijgbare boormachines en accuboormachines.

Art.-nr.	Ø flensschijven	Ø mm	h mm			EAN
501000	34	10	6		6	4 009315 010007
501200	34	1/2" / 12,75	8		6	4 009315 012001



... altijd de passende toebehoren voor uw machine!





# **BOVENFREZEN HARDMETALEN SCHAAFMESSEN**

## Bovenfrezen



### Voordelen van de bovenfrezen

- Bovenfrezen met 8mm-schacht voor het frezen van verschillende gleuven en profielen in hard- en zachthout
- Geschikt voor alle normale handgeleide bovenfreesmachines
- Ideaal voor alle standaard toepassingen in de werkplaats, op de bouwplaats en in de hobby ruimte

## Programma overzicht bovenfrezen en hardmetalen schaafmessen

Bovenfrezen zijn alleen geschikt voor gebruik in normale handgeleide bovenfreesmachines en mogen om veiligheidsredenen niet in boormachines worden geklemd.

### BELANGRIJK:

Wegens het zeer hoge toerental dient men absoluut veiligheidshandschoenen en een veiligheidsbril te dragen.



### Gleuffrezen

★★★★★

Van HSS-staal, met twee snijkanten, precisiegelepen, voor gebruik in alle normaal verkrijgbare handgeleide bovenfreesmachines. Precies frezen van gleuven in vezelig hard- en zachthout en plastic materialen.

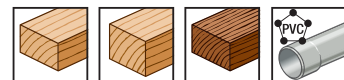

Pagina 206

### kwb-Info

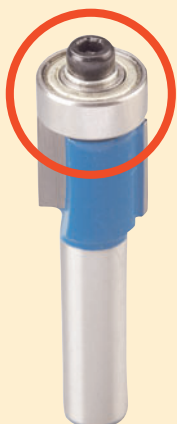

### Een aanloopkogellager - wat is dat?

Een aanloopkogellager aan de kop van een bovenfrees zorgt voor een optimale en precieze geleiding bij het frezen. Zo zijn zuivere oppervlakken zonder schade aan het werkstuk verzekerd.

### Hardmetalen frezen met aanloopkogellager

★★★★★

Met hardmetaal versterkte gleuf- en profielfrezen met een lange levensduur voor houtbewerking, met twee snijkanten en een aanloopkogellager. Precisiegelepen, voor gebruik in alle normaal verkrijgbare handgeleide bovenfreesmachines. Precies frezen van gleuven, sponningen en profielen in hard- en zachthout, spaanplaten en multiplex.

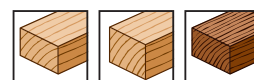

Pagina 207 - 210

## Hardmetalen schaafmessen



### Hardmetalen schaafmessen

- Hardmetalen omkeerbare schaafmessen voor alle normale elektrische schaven voor houtbewerking

### Altijd het juiste schaafmes

Bij een groot aantal elektrische schaven is het niet zo eenvoudig om het geschikte schaafmes te vinden. De kwb-machinewijzer is gerangschikt op fabrikant en biedt snel een eenvoudig overzicht. De machinewijzer vindt u op pagina 211 in onze catalogus.

### Hardmetalen frezen ★★★★★



Met hardmetaal versterkte gleuf- en profielfrezen met een lange levensduur voor houtbewerking, met twee snijkanten. Precisiegeslepen, voor gebruik in alle normaal verkrijgbare handgeleide bovenfreesmachines. Precies frezen van gleuven, sponningen en profielen in hard- en zacht hout, spaanplaten en multiplex.

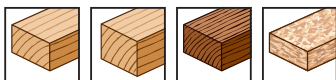

Pagina 207 - 210

### Hardmetalen schaafmessen ★★★★★



Speciale hardmetalen schaafmessen met 2 snijkanten. Precisiegeslepen, voor gebruik in normaal verkrijgbare elektrische schaven, voor het schaven van hard- en zacht hout.

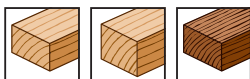

Pagina 211

### kwb-info

## Een kwestie van veiligheid



Veiligheidshandschoenen moeten worden gedragen bij alle werkzaamheden waarbij handletsels kunnen optreden. Bij al dergelijke toepassingen, bijv. in de bouw, bij voorwerpen met scherpe randen enz., dient men de handen te beschermen. Bij alle werkzaamheden zijn grip en optimaal draagcomfort basisvoorwaarden voor de juiste veiligheidshandschoenen.

Alle informatie hierover vindt u in onze kwb-folder voor arbeidsveiligheid of op het internet op [www.kwb.eu](http://www.kwb.eu).

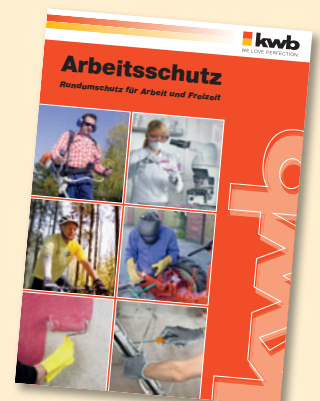

**Gleuffrees HSS**



Gleuffrees, HSS-staal, 2-snijder, precisiegeslepen snijkanten, voor universele freeswerkzaamheden voor het maken van gleuven, sponningen en slobgaten, voor hard- en zacht-hout en plastic materialen, voor alle normaal verkrijgbare handgeleide bovenfreesmachines.

Art.-nr.	Ø mm	l mm			EAN
750410	4	8		1	4 009317 504108
750510	5	8		1	4 009317 505105
750610	6	8		1	4 009317 506102
750810	8	8		1	4 009317 508106
751010	10	8		1	4 009317 510109

**Gleuffrees HSS**



Gleuffrees, HSS-staal, 2-snijder, precisiegeslepen snijkanten, voor universele freeswerkzaamheden voor het maken van gleuven, sponningen en slobgaten, voor hard- en zacht-hout en plaatmaterialen, voor alle normaal verkrijgbare handgeleide bovenfreesmachines.

Art.-nr.	Ø mm	l mm			EAN
754620	6	8		1	4 009317 546207
754820	8	8		1	4 009317 548201
754420	10	8		1	4 009317 544206
754520	12	8		1	4 009317 545200
754720	14	8		1	4 009317 547204
754320	18	8		1	4 009317 543201
754920	16	8		1	4 009317 549208
755020	20	8		1	4 009317 550204

**Holprofielfrees HM**



Holprofielfrees, met hardmetaal versterkt, 2-snijder, precisiegeslepen snijkanten, voor het maken van randprofielen, decoratieve siergleuven, structurering van oppervlakken en voor gebruik in kopieerfreesmachines, voor hard- en zacht-hout, voor alle normaal verkrijgbare handgeleide bovenfreesmachines.

Art.-nr.	Ø mm	Straal R	l mm			EAN
755820	12,7	R = 9,4	8		1	4 009317 558200
754120	19,0	R = 12,0	8		1	4 009317 541202

## Bovenfreesen

### Holprofielfrees HM, met aanloopkogellager



Holprofielfrees, met hardmetaal versterkt, 2-snijder, precisiegeslepen snijkanten, voor het maken van halve holle sleuven, voor hard- en zacht hout, voor alle normaal verkrijgbare handgeleide bovenfreesmachines.

Art.-nr.	Ø mm	Straal R	mm			EAN
755920	25,7	6,35	8		1	4 009317 559207

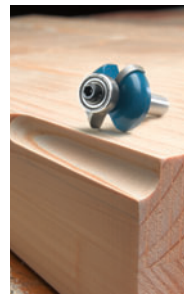

### V-gleuffrees HM



V-gleuffrees, met hardmetaal versterkt, 2-snijder, precisiegeslepen snijkanten, voor het frezen van V-gleuven, decoratieve siergleuven en structurering van oppervlakken en voor gebruik in kopieerfreesmachines, de frees freest niet tot helemaal in de punt, de gleuf blijft ong. 1 mm afgevlakt, voor hard- en zacht hout en plaatmateriaal, voor alle normaal verkrijgbare handgeleide bovenfreesmachines.

Art.-nr.	Ø mm	Hoek	mm			EAN
755120	14	W = 90°	8		1	4 009317 551201



### Zwaluwstaartfrees HM, met snijder



Zwaluwstaartfrees, met hardmetaal versterkt, 2-snijder, precisiegeslepen snijkanten, voor het maken van zichtbare en onzichtbare zwaluwstaartverbindingen bij rompen en laden in meubelen, voor hard- en zacht hout, voor alle normaal verkrijgbare handgeleide bovenfreesmachines.

Art.-nr.	Ø mm	Hoek	mm			EAN
756020	14	W = 14°	8		1	4 009317 560203



### Sponningfrees HM, met aanloopkogellager



Sponningfrees, met hardmetaal versterkt, 2-snijder, precisiegeslepen snijkanten, voor het maken van sponningen in massief hout voor meubelen, ramen, deuren en lijsten, voor hard- en zacht hout, voor alle normaal verkrijgbare handgeleide bovenfreesmachines.

Art.-nr.	Ø mm	mm			EAN
756220	31,7	8		1	4 009317 562207



**Afrondfrees HM, met aanloopkogellager**



Afrondfrees, met hardmetaal versterkt, 2-snijder, precisiegeslepen snijkanten, voor het afronden van randen bij stellingkasten, tafelbladen, kasten en ramen, voor hard- en zachthout en plaatmaterialen, voor alle normaal verkrijgbare handgeleide bovenfreesmachines.

Art.-nr.	Ø mm	Straal R	⌘ mm			EAN
756620	25,7	R = 6,35	8		1	4 009317 566205
756420	32	R = 9,52	8		1	4 009317 564201

**Kwartrondprofielfrees HM, met aanloopkogellager**



Kwartrondprofielfrees, met hardmetaal versterkt, 2-snijder, precisiegeslepen snijkanten, voor het maken van kwartronde profielen, voor hard- en zachthout, voor alle normaal verkrijgbare handgeleide bovenfreesmachines.

Art.-nr.	Ø mm	Straal R	⌘ mm			EAN
756320	25,4	R = 6,35	8		1	4 009317 563204
756120	31,7	R = 9,52	8		1	4 009317 561200

**Afkantfrees HM, met geleidingslager**



Fasefrees, met hardmetaal versterkt, 2-snijder, precisiegeslepen snijkanten, voor het afkanten van randen bij regelmatige of gewelfde werkstukken, voor hard- en zachthout en plaatmaterialen, voor alle normaal verkrijgbare handgeleide bovenfreesmachines.

Art.-nr.	Ø mm	Hoek	⌘ mm			EAN
756520	35,5	W = 45°	8		1	4 009317 565208

**Kantenfrees HM**



Kantenfrees, met hardmetaal versterkt, 2-snijder, precisiegeslepen snijkanten, voor het afkanten van randen bij regelmatige of gewelfde werkstukken, voor hard- en zachthout en plaatmaterialen, voor alle normaal verkrijgbare handgeleide bovenfreesmachines.

Art.-nr.	Ø mm	Hoek	⌘ mm			EAN
755220	11,7	W = 22°	8		1	4 009317 552208





## Bovenfreesen

### T-gleuffrees (ophanggleuffrees)



T-gleuffrees, met hardmetaal versterkt, 2-snijder, precisiegeslepen snijkanten, voor het frezen van T-gleuven, gleuven in lijsten om vlak tegen de wand op te hangen, ophangsleutelgaten en zeskantschroefgeleidingen of voor het verzinken van elektriciteitskabels, voor hard- en zacht hout en plaatmateriaal, voor alle normaal verkrijgbare handgeleide bovenfreesmachines.



Art.-nr.	Ø mm	T mm			EAN
755520	5 / 9,5	8		1	4 009 317 555 209



### Vlakfrees HM, met aanloopkogellager



Vlakfrees, met hardmetaal versterkt, 2-snijder, precisiegeslepen snijkanten, voor het vlak- of uitfrezen van openingen van contactdozen, schakelaars, uitsnijdingen voor lampen bij wandenbouw, winkelinrichting en standenbouw, voor hard- en zacht hout, plaatmateriaal en kunststof randen, voor alle normaal verkrijgbare handgeleide bovenfreesmachines.



Art.-nr.	Ø mm	T mm			EAN
755420	13	8		1	4 009 317 554 202



### Graveerfrees HM



Graveerfrees, met hardmetaal versterkt, 2-snijder, precisiegeslepen snijkanten, voor het maken van geschriften of gravures in massief hout en plaatmaterialen en voor gebruik in kopieerfreesmachines, voor hard- en zacht hout, voor alle normaal verkrijgbare handgeleide bovenfreesmachines.



Art.-nr.	Ø mm	T mm			EAN
755720	8	8		1	4 009 317 557 203



### Profielfrees HM, met aanloopkogellager



Profielfrees, met hardmetaal versterkt, 2-snijder, precisiegeslepen snijkanten, voor het maken van profielen op werkstukken in modelbouw, ramen, kroonlijsten en lijsten, voor hard- en zacht hout en plaatmateriaal, voor alle normaal verkrijgbare handgeleide bovenfreesmachines.

Art.-nr.	Ø mm	Straal R	T mm			EAN
756720	39,2	R = 4,79 / 6,35	8		1	4 009 317 567 202



**Profielfrees HM**



Profielfrees, met hardmetaal versterkt, 2-snijder, precisiegeslepen snijkanten, voor het maken van profielen op werkstukken in modelbouw, ramen, kroonlijsten en lijsten, voor hard- en zacht hout en plaatmateriaal, voor alle normaal verkrijgbare handgeleide bovenfreesmachines.

Art.-nr.	Ø mm	Straal R	⌘ mm			EAN
756820	12,7	R = 3,2	8		1	4 009317 568201

**Profielfrees HM, met aanloopkogellager**



Profielfrees, met hardmetaal versterkt, 2-snijder, precisiegeslepen snijkanten, voor het maken van profielen op werkstukken in modelbouw, ramen, kroonlijsten en lijsten, voor hard- en zacht hout en plaatmateriaal, voor alle normaal verkrijgbare handgeleide bovenfreesmachines.

Art.-nr.	Ø mm	Straal R	⌘ mm			EAN
756920	28,1	6,35	8		1	4 009317 569206

**Schijfgleuffrees HM, met klemschacht**

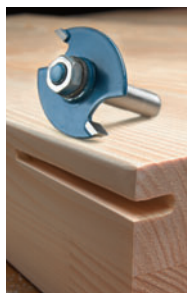

Schijfgleuffrees, met hardmetaal versterkt, 2-snijder, precisiegeslepen snijkanten, voor het snijden van rechte gleuven in smalle randen, bijv. voor messing-en-groefverbindingen, verbindingen/plaatjes/platte deuvels of afdichtingen, voor hard- en zacht hout en plaatmateriaal, voor alle normaal verkrijgbare handgeleide bovenfreesmachines.

Art.-nr.	⌘	⌘ mm			EAN
754020	2,0	8		1	4 009317 540205
754030	3,0	8		1	4 009317 540304
754040	4,0	8		1	4 009317 540403

## Omkeerbare schaafmessen HM



Hardmetalen omkeerbare schaafmessen met 2 snijkanten, recht, precisiegeslepen, speciaal hardmetaal, voor schaafwerkzaamheden in meubelbewerking en interieurinrichting, voor het schaven van hard- en zacht hout, voor gebruik in de gewoon verkrijgbare elektrische schaven.



Art.-nr.	Breedte	kwb-code	Lengte	↕	↔	📦	EAN
567502	5,5	H 75	75,5	1,1	↔	1	4 009315 675022
568102	5,5	H 81	82,7	1,2	↔	1	4 009315 681023
568302	5,5	H 83	82	1,1	↔	1	4 009315 683027

Fabrikant/machinetype	kwb Code	H 75	H 81	H 83
	Art.-nr.	5675-	5681-	5683-
<b>AEG</b>				
HTH 75		x		
EH 82/822, EH 450, H 750, EH 823, E 500, EH 82 S, EH 700 (R), EH 82-1				x
<b>BLACK &amp; DECKER</b>				
DN 750, DN 75, SR 600 K, BD 750, KW 750		x		
DN 710/712, P 71-02, PL 806, P 71-03, DN 730			x	
BD 710, BD 711, DN 730, DN 740, KW 735 E, KW 725, KW 713				x
<b>BOSCH</b>				
PHO 150, PHO 200, PHO 300, PHO 100, PHO 2-82, PHO 3-82, GHO 3-82, GHO 31-82, GHO 36-82 C				x
<b>CASALS</b>				
CE 82				x
<b>FEIN</b>				
HS 2151				x
<b>FELISATTI</b>				
TP 282				x
<b>FESTO</b>				
REP 75		x		
<b>HAFFNER</b>				
FH 222		x		
FH 224		x		x
<b>HITACHI</b>				
F 20, F 20 A, FP 20 A, FP 20 SA, FU 20, P 20 SA, P 20 V				x
<b>HOLZ-HER</b>				
2286, 2320, 2321, (2322), 2223 (R 1985)		x		
2330, 2321, 2323, 2223 (1989 R)				x
<b>KRESS</b>				
Jet Star 6701, 6702		x		
EH 6782-3				x
<b>MAFELL</b>				
HU 75		x		
EHU 82, MHU 82/ EH 82 S				x
<b>MAKITA</b>				
1100, 1125 B, 1900 B, 1923 H, 1923 B, 1001, 1901				x
<b>METABO</b>				
6375		x		
HO 4382, HO 0882, HO 8382, Gustav (HO 3360), HO 0883, HO 0983				x
<b>PERLES</b>				
HHB 82 B				x
<b>PEUGEOT</b>				
BRA 3-82, RA 400, 82 RAC, RA 3082 C, RA 1082 CA, BR 82				x
<b>SCHEER</b>				
MH 80, MH 75/3		x		
<b>SKIL</b>				
98 H		x		
92 H, 94 H, 95 H, 96 H, 97 H				x

... altijd de passende toebehoren voor uw machine!

# LINE MASTER

Het gepatenteerde liniaalsysteem met meer dan 50 toepassingen voor nauwkeurig werken. kwb, meer dan 80 jaar perfectie.

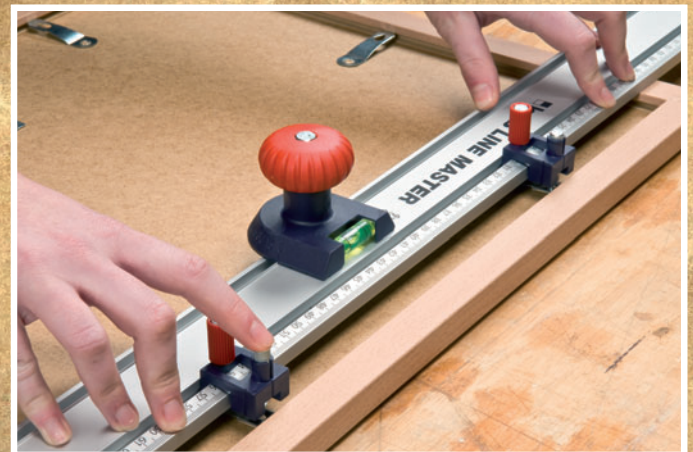
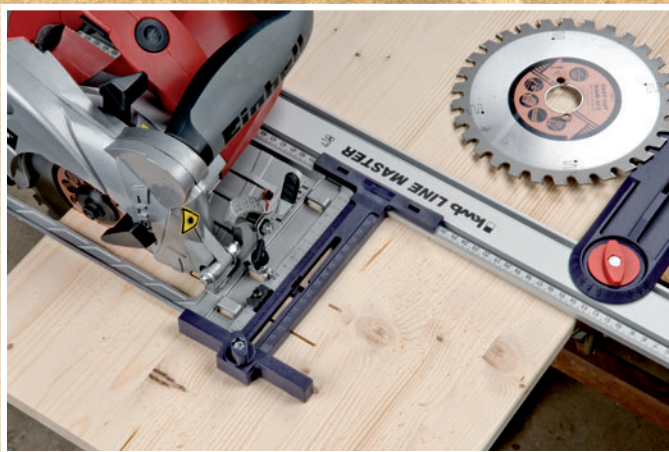

Meten, markeren, zagen,  
snijden en geleiden met  
één systeem:

# LINE MASTER

De gepatenteerde precisieliniaal vormt de kern van het **LINE MASTER**-systeem.

Bij deze precisieliniaal is een omvangrijk assortiment van toebehoren verkrijgbaar.



Verkrijgbaar in drie lengten:  
800 mm Art.-nr. 784208  
1000 mm Art.-nr. 784210  
1200 mm Art.-nr. 784212

## LINE MASTER set



De hoekaanslag voor hoekinstellingen tussen 30° - 150° in stappen van 15°.



De mesgeleiding voor zuivere en rechte sneden met een universeel hobbymes.



De vastzetklem om het precisieliniaal goed te bevestigen.



De handgreepset met boorpuntmarkeerders is een onontbeerlijk hulpmiddel bij vele wandmontage werkzaamheden.



De zaaggeleiding voor een precieze geleiding van decoupeer- en cirkelzagen.

## LINE MASTER toebehoren



Het liniaalverlengstuk is ideaal voor extra grote werkstukken.



De bovenfreesgeleiding freest nauwkeurig rechte- of cirkelvormige profielen.



De cirkelsnijder snijdt nauwkeurig halve cirkels en krommes.



Met de geleiding voor de Dübelprofi boort men exacte deувelgaten in houten platen.







## LINE MASTER precisieliniaal



Het LINE MASTER-precisieliniaal van geanodiseerd aluminium met geleidingsgroeven vormt de kern van het LINE MASTER-systeem, dat een onovertroffen aantal toepassingsmogelijkheden biedt.

De mm-schaal is met een speciale kunststofharsverf aangebracht en is daardoor extreem slijtvast.

De LINE MASTER-precisielinialen voldoen aan de eisen van nauwkeurigheidsklasse II de Physikalisch Technische Bundesanstalt.

Art.-nr.	Breedte	Lengte				EAN
784208	58	800	10		2	4 009317 842088
784210	58	1000	10		2	4 009317 842101
784212	58	1220	10		2	4 009317 842125



## LINE MASTER hoekaanslag, 15°-indeling



De stabiele hoekaanslag past op alle LINE MASTER precisielinialen. De hoek wordt in stappen van 15° tussen 30 en 150° ingesteld. Door de inschuifbare aanslagtong aan de onderkant kan de hoek als aanslag of steun worden gebruikt. Glasvezelversterkte kunststof.

Art.-nr.	Inhoud			EAN
784300	LINE MASTER Hoekaanslag, kunststof glasvezelversterkt, 15° instelling		2	4 009317 843009



**LINE MASTER klemtang**



Met de vastzetklemmen bevestigt u alle LINE MASTER-precisielinialen snel en absoluut vast op het werkstuk, bijvoorbeeld bij het zagen met de LINE MASTER-zaaggeleiding.

U kunt ook het werkstuk tussen het LINE MASTER precisieliniaal en het werkblad klemmen, bijvoorbeeld bij het snijden met de LINE MASTER-mesgeleiding. Spanklauwen van glasvezelversterkte kunststof.

Art.-nr.	Inhoud			EAN
784500	LINE MASTER Spanklem, spanbek uit kunststof, glasvezelversterkt		2	4 009317 845003

**LINE MASTER machinegeleiding**



De zaaggeleiding is wellicht het geniaalste onderdeel van het LINE MASTER systeem.

Decoupeerzagen, cirkelzagen (tot Ø 190 mm) en bovenfrezen worden zo precies geleid, dat scheve en onnauwkeurige zaagsneden definitief tot het verleden behoren. Glasvezelversterkte kunststof met meetschaal.

Art.-nr.	Inhoud			EAN
784400	LINE MASTER Machinegeleiding, kunststof glasvezelversterkt, met schaalverdeling		2	4 009317 844006



## LINE MASTER mesgeleiding



Met de mesgeleiding kunt u langs alle LINE MASTER precisielinialen breek-, trapezium- en haakmessen veilig en heel precies geleiden. Door de meshouder aan beide zijden kan het mes voorwaarts en achterwaarts worden bewogen zonder dat het LINE MASTER-liniaal moet worden opgetild: een groot voordeel bij het bijsnijden. Glasvezelversterkte kunststof.

Art.-nr.	Inhoud			EAN
784600	LINE MASTER mesgeleider, kunststof glasvezelversterkt		2	4 009317 846000



## LINE MASTER handgreepset met boorpuntmarkeerder



Deze praktische handgreep met libel maakt van elk LINE MASTER precisieliniaal een waterpas en vergemakkelijkt het gebruik ervan: En het bijzondere is: de libel kan in stappen van 15° worden gedraaid. De twee boorpuntmarkeerders worden op de mm-schaal van het LINE MASTER precisieliniaal geplaatst en met een handgreep vastgezet. Een onontbeerlijk hulpmiddel bij vele wandmontagewerkzaamheden.

Art.-nr.	Inhoud			EAN
784800	1 LINE MASTER handgreep, 2 boorpuntmarkeerders met stalen punt		1	4 009317 848004



**LINE MASTER universele set**



Het gepatenteerde liniaalsysteem als 10-delige universele totaalset voor nuttig gebruik bij het doe-het-zelven.

De set bestaat uit een precisieliniaal van 80 cm resp. 120 cm (art.-nr. 784208 resp. 784212), instelbare hoekaanslag (art.-nr. 784300), twee vastzetklemmen (art.-nr. 784500), een zaaggeleiding voor cirkel- en decoupeerzagen (art.-nr. 784400), een mesgeleiding (art.-nr. 784600), een cuttermes (art.-nr. 014000) en een set handgrepen met boorpuntmarkeerders (art.-nr. 784800).

Art.-nr.	Inhoud			EAN
783408	LINE MASTER universele set		1	4 009317 834083
783412	LINE MASTER universele set		1	4 009317 834120
783908	LINE MASTER universele set		1	4 009317 839088

Inhoud	Art.-nr.	Art.-nr.	Art.-nr.
<b>LINE MASTER SET</b>	783908	783408	783412
Precisieliniaal van 800 mm 	Art.-nr. 784208	✓	✓
Precisieliniaal van 1200 mm 	Art.-nr. 784212		✓
Hoekaanslag 	Art.-nr. 784300	✓	✓
Vastzetklemmen 	Art.-nr. 784500	✓	✓
Zaaggeleiding voor cirkel- en decoupeerzagen 	Art.-nr. 784400	✓	✓
Mesgeleiding 	Art.-nr. 784600	✓	✓
Set handgrepen met boorpuntmarkeerders 	Art.-nr. 784800	✓	✓
Cuttermes 	Art.-nr. 014000	✓	✓

**LINE MASTER professionele set**

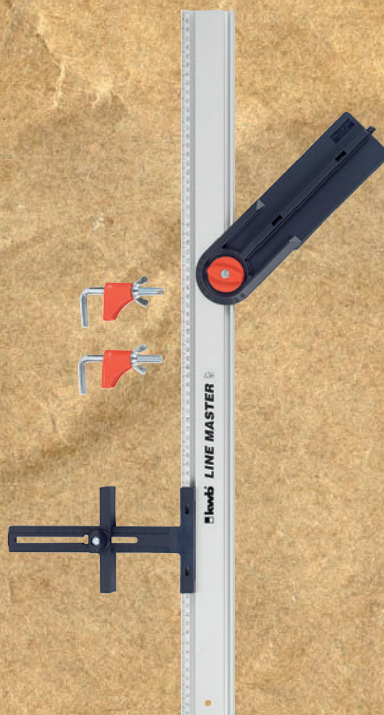

Het gepatenteerde liniaalsysteem als 5-delige professionele startset voor nuttig gebruik bij het doe-het-zelven.

De professionele startset bestaat uit een 80cm-precisieliniaal (art.-nr. 784208), instelbare hoekaanslag (art.-nr. 784300), twee vastzetklemmen (art.-nr. 784500), een zaaggeleiding voor cirkel- en decoupeerzagen (art.-nr. 784400).

Art.-nr.	Inhoud			EAN
784008	LINE MASTER professionele set		1	4 009317 840084



Inhoud	Art.-nr.
<b>LINE MASTER SET</b>	784008
Precisieliniaal van 800 mm 	Art.-nr. 784208
Hoekaanslag 	Art.-nr. 784300
Vastzetklemmen 	Art.-nr. 784500
Zaaggeleiding voor cirkel- en decoupeerzagen 	Art.-nr. 784400

## LINE MASTER liniaalverbinder



Een meter volstaat vaak niet. Met het liniaalverlengstuk kunt u nu twee of meer LINE MASTER precisielinialen veilig en precies tot één liniaal met elkaar verbinden.

De geleidingsleuf blijft vrij, zodat ook lange zaagsneden zonder onderbreking mogelijk zijn. Kunststof profiel, glasvezelversterkt, 4-voudige schroefverbinding.

Art.-nr.	Lengte			EAN
784900	250		1	4 009317 849001

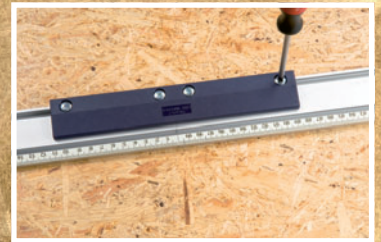

## LINE MASTER cirkelgeleiding voor decoupeerzagen, met centreerhouder



Met de LINE MASTER cirkelgeleiding voor decoupeerzagen verloopt het zagen van cirkels, halve cirkels en krommes zo nauwkeurig en juist, dat het lijkt alsof ze met een passer getekend zijn.

Art.-nr.	Inhoud			EAN
783600	LINE MASTER cirkelgeleiding voor decoupeerzagen, met centreerhouder		1	4 009317 836001

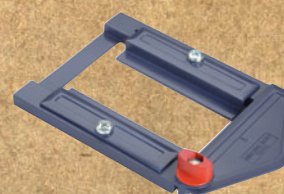
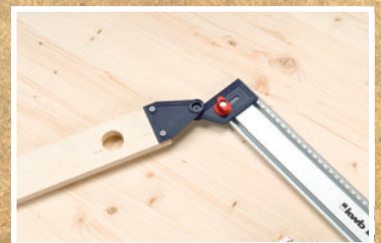

**LINE MASTER bovenfreesgeleiding, met centreerhouder**



Met de bovenfreesgeleiding van het LINE MASTER systeem kunt u cirkelvormige profielen heel precies frezen.

Ook hier kan de centrering gebeuren met of zonder spijker in het werkstuk. U kunt de bovenfrees natuurlijk ook langs de LINE MASTER precisieliniaal geleiden, om heel eenvoudig absoluut rechte profielen te frezen.

Art.-nr.	Inhoud			EAN
783500	LINE MASTER bovenfreesgeleiding, met centreerhouder		1	4 009317 835004

**LINE MASTER geleiding voor kwb DÜBELPROFI**

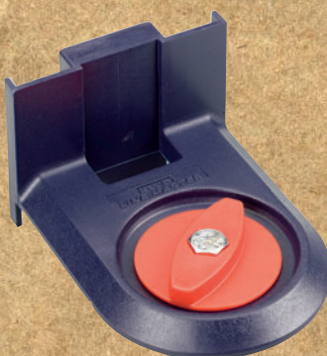

Samen met de DÜBELPROFI van kwb (art.-nr. 758000) maakt u serieboringen exact op maat voor de constructie van stellingkasten of vakverdelingen in kasten. Geschikt voor alle LINE MASTER-precisielinialen. Glasvezelversterkte kunststof.

Art.-nr.	voor			EAN
784700	758000 / 758100		2	4 009317 847007



**DECOUPEERZAAGBLADEN**  
**RECIPROZAAGBLADEN**  
**MULTITool-TOEBEHOREN**

## Decoupeerzaagbladen, reciprozaagbladen

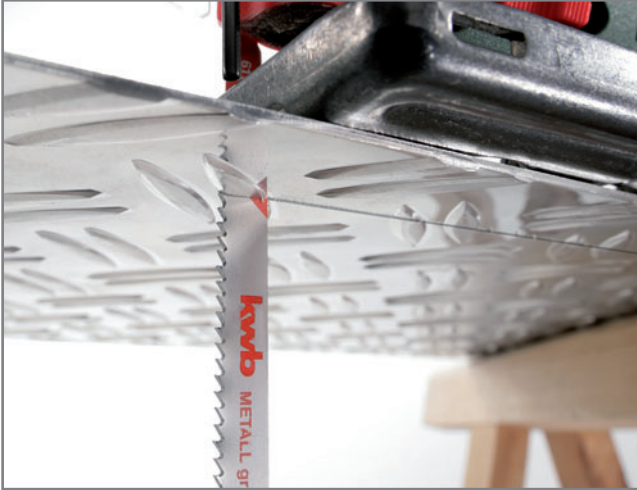

### Voor elke toepassing altijd het passende zaagblad

- **Decoupeerzaagbladen**  
Voor het zagen van hout, metaal, laminaat, kunststof, tegels/keramiek, gres, rubber
- **Reciprozaagbladen**  
Voor het zagen van hout, bomen, groenhout, hardhout, metaal, tegels/keramiek, gres

## Kwaliteiten

### HCS-staal

Decoupeerzaagbladen van koolstofstaal, gezet, gescherpt of kruisgeslepen, voor het bewerken van hard-/zachthout en kunststoffen

### HSS

Volledig gehard sneldraaistaal, voor gebruik in hardere materialen, voor metaal, aluminium, non-ferrometaal enz.

### BI-metaal

Zeer flexibel, nagenoeg onbreekbare verbinding van HSS- en HCS-staal, ook voor gebruik in hardere materialen, extreem buigzaam, voor hout, non-ferrometaal, aluminium, bijzonder geschikt voor abrasieve materialen

### Met hardmetaal (HM) bestrooid

HCS-draagblad met hardmetaal bestrooid, speciaal voor gebruik in tegels, keramiek, glas, baksteen, gietstukken en abrasieve materialen

### Met DIAMANT bestrooid

Met diamant bestrooid, ideaal voor schone, rechte zaagsneden, het bewerken van tegels en keramiek, voor gres, porselein, glas, gietijzer, marmer

## kwb-info

### Overzicht schachten



#### T-schaft

De T-schaft is bij decoupeerzaagbladen de meest gebruikelijke schacht. Hij past in nagenoeg alle nieuwe, gangbare decoupeerzagen.



#### U-schaft

De U-schaft of universele schacht past in vele gangbare decoupeerzagen.

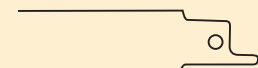

#### S-schaft

De S-schaft of 1/2"-reciprozaagschaft past in vele gangbare elektrische reciproc- en universele zagen.

## Multitool-toebehoren



### kwb-allrounder voor vele toepassingsmogelijkheden

- Veelzijdige toepassingsmogelijkheden, bijv. zagen, frezen, raspen, schaven, slijpen
- Uitgebreid kwb-toebehorenprogramma voor multifunctionele werktuigen van alle gangbare merken
- QUICK-CHANGE voor eenvoudig en snel verwisselen van de toebehoren

## Programma overzicht multitool-toebehoren



### Invalzaagbladen ★★★★★

Op elke plaats eenvoudig invallen in het materiaal, probleemloos invalzagen in parket, keukenwerkbladen, kasten of gipsplaten, verschillende uitvoeringen voor hout of metaal, voor bijzonder schone en snelle zaagsneden is het invalzaagblad met Japanse vertanding geschikt (zie afbeelding).

Pagina 239 - 240



### Zaagbladen ★★★★★

Voor het frezen van voegen bij tegels met zaagbreedten van 1,3 mm tot zaagdiepten van 85 mm, ideaal voor werkzaamheden tot in hoeken, invallen in het materiaal en werkzaamheden op effen oppervlakken, bijv. bij het uitzagen van beschadigde voegen, ook geschikt voor het frezen van sleuven of buizen.

Pagina 240



### Rasp ★★★★★

Raspt en verwijdert mortel, tegelijm en tapijtresten, ook geschikt voor het grof slijpen en gladmaken van plamuur, beton, steen en hout, gebruik op oppervlakken tot in elke hoek, smalle tussenruimten en randen, voor gebruik in machines met of zonder stofafzuiging.

Pagina 241



### Schraapstaal ★★★★★

Hard of flexibel, voor het schaven van harde en zachte materialen, verwijdert tapijtresten, oude en beschadigde siliconen- of acrylvoegen of lossen verfrezen van hout en metaal.

Pagina 241



### Sets ★★★★★

**Tegelreparatieset, 3-delig:**  
Voor tegel- en mortelreparaties  
**Vloer- en inbouwset, 4-delig:**  
Voor hout- en reparatiewerkzaamheden  
**Universele set, 17-delig:**  
Voor hout-, slijp- en reparatiewerkzaamheden

Pagina 242 - 243

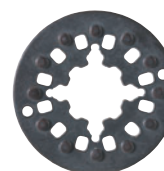

### Universele adapter ★★★★★

Met de universele adapter passen de multitool-toebehoren van kwb op talrijke gangbare multicutters, allrounders of multifunctionele gereedschappen.

Pagina 243

**EASY CUT decoupeerzaagbladen, houtbewerking, HCS-koolstofstaal**



EASY-CUT decoupeerzaagbladen HCS-koolstofstaal, gehard, tanden kruis- en onder vrije hoek geslepen, voor snelle en rechte sneden, progressieve tandverdeling, de afstand tussen de tanden neemt toe van fijn aan het schachtuiteinde tot grof aan de punt, zo is zowel in dikke als dunne materialen altijd een nagenoeg zuivere snijrand verzekerd, met priktand voor probleemloos invallend zagen, voor hout, spaan-, meubel- en vezelplaten en zachte kunststof.

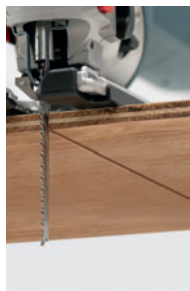

Art.-nr.		BOSCH-nr.	Inhoud	Lengte	Snede			EAN
<b>T-schacht</b>								
623020		T234X	2	116/93	Fijn-grof		5	4 009316 230206

Art.-nr.		BOSCH-nr.	Inhoud	Lengte	Snede			EAN
<b>Universele schacht</b>								
623030		U234X	2	116	Fijn-grof		5	4 009316 230305

**Decoupeerzaagbladen, houtbewerking, bimetaal**



Decoupeerzaagbladen, BIM, bimetaal, gehard, tanden kruis-, onder vrije hoek en conisch geslepen, snelle zuivere sneden, met priktand voor probleemloos invallend zagen, voor hout, hardhout, spaan-, meubel- en vezelplaten, platen met kunststof coating, zachte kunststoffen en glasvezelversterkte kunststoffen.



Art.-nr.		BOSCH-nr.	Inhoud	Lengte	Snede			EAN
<b>T-schacht</b>								
620120		T101B	2	100/75	fijn		10	4 009316 201206
620220		T101D	2	100/75	Medium		10	4 009316 202203
620320		T144D	2	100/75	grof		10	4 009316 203200
620620		T101A0	2	77/50	Curve		10	4 009316 206201

Art.-nr.		BOSCH-nr.	Inhoud	Lengte	Snede			EAN
<b>T-schacht, extra lang</b>								
623220		T344D	2	152	grof		10	4 009316 232200
623320		T301CD	2	116/93	grof/lang		5	4 009316 233207



## Decoupeerzaagbladen, houtbewerking, bimetaal



Art.-nr.		BOSCH-nr.	Inhoud	Lengte	Sneede			EAN
<b>T-schacht, professionele verpakking</b>								
620125	2,5	T101B	5	100/75	fijn		6	4 009316 201251
620225	4	T101D	5	100/75	Medium		6	4 009316 202258
620325	4	T144D	5	100/75	grof		6	4 009316 203255
620625	1,35	T101AQ	5	77/50	Curve		6	4 009316 206256



Art.-nr.		BOSCH-nr.	Inhoud	Lengte	Sneede			EAN
<b>Universele schacht</b>								
620130	2,35	U101B	2	100/80	fijn		10	4 009316 201305
620230	4	U101D	2	100/80	Medium		10	4 009316 202302
620330	4	U144D	2	100/80	grof		10	4 009316 203309
620630	1,35	U1A0	2	70/50	Curve		10	4 009316 206300



Art.-nr.		BOSCH-nr.	Inhoud	Lengte	Sneede			EAN
<b>Universele schacht, professionele verpakking</b>								
620135	2,5	U101B	5	100/80	fijn		6	4 009316 201350
620235	4	U101D	5	100/80	Medium		6	4 009316 202357
620635	1,35	U1A0	5	70	Curve		6	4 009316 206355



## Decoupeerzaagbladen, houtbewerking, conisch geslepen, bimetaal



Art.-nr.		BOSCH-nr.	Inhoud	Lengte	Sneede			EAN
<b>T-schacht</b>								
621020	2,5	T101BF	2	100/75	fijn		10	4 009316 210208



Decoupeerzaagbladen, BIM, bimetaal, gehard, tanden kruis-, onder vrije hoek en conisch geslepen, snelle zuivere sneden, met priktand voor probleemloos invallend zagen, voor hout, hardhout, spaan-, meubel- en vezelplaten, platen met kunststof coating, zachte kunststoffen en glasvezelversterkte kunststoffen.

**Decoupeerzaagbladen, houtbewerking, HCS-koolstofstaal**



Decoupeerzaagbladen, HCS-koolstofstaal, gehard, geslepen tanden, extra sterk blad, voor bijzonder snelle, rechte sneden met precieze hoeken, ook in dik materiaal, voor hout, dik bouwhout, spaan-, meubel- en vezelplaten, zachte kunststof, deuren en keukenwerkbladen tot 50 mm dik.



Art.-nr.		BOSCH-nr.	Inhoud	Lengte	Snede			EAN
<b>T-schacht</b>								
620420	4,0	T144DP	2	100	grof		10	4 009316 204207

Art.-nr.		BOSCH-nr.	Inhoud	Lengte	Snede			EAN
<b>T-schacht, professionele verpakking</b>								
620425	4,0	T144DP	5	100	grof		6	4 009316 204252

**Decoupeerzaagbladen, houtbewerking, DOWN CUT, HCS-koolstofstaal**



Decoupeerzaagbladen, Down Cut, optimaal voor zuivere snijranden bij de bewerking van het materiaal vanaf de zichtbare zijde, HCS-koolstofstaal, gehard, geslepen tanden, voor snelle, rechte en zuivere sneden, voor hout, multiplex, spaan-, meubel- of vezelplaten, platen met kunststof coating en keukenwerkbladen tot 30 mm dik.



Art.-nr.		BOSCH-nr.	Inhoud	Lengte	Snede			EAN
<b>T-schacht</b>								
620820	2,5	T101BR	2	100/75	fijn		10	4 009316 208205

Art.-nr.		BOSCH-nr.	Inhoud	Lengte	Snede			EAN
<b>T-schacht, professionele verpakking</b>								
620825	2,5	T101BR	5	100/75	fijn		6	4 009316 208250

# Decoupeerzaagbladen

## Decoupeerzaagbladen, houtbewerking, DOWN CUT, HCS-koolstofstaal



Art.-nr.		BOSCH-nr.	In-houd	Lengte	Snedes			EAN
<b>Universele schacht</b>								
620830	2,5	U101BR	2	100	fijn		10	4 009316 208304



## Decoupeerzaagbladen, LAMINAAT, houtbewerking, bimetaal



Art.-nr.		BOSCH-nr.	In-houd	Lengte	Snedes			EAN
<b>T-schacht</b>								
620520	1,7	T101BIF	2	83	fijn		10	4 009316 205204
620920	1,4	T101AOF	2	83	Curve		10	4 009316 205202

Decoupeerzaagbladen, BIM, bimetaal, gehard, tanden kruis- en onder vrije hoek geslepen, snelle zuivere sneden, met priktand voor probleemloos invallend zagen, voor laminaat, platen met kunststof coating, multiplex, hout en hardhout.



Art.-nr.		BOSCH-nr.	In-houd	Lengte	Snedes			EAN
<b>T-schacht, professionele verpakking</b>								
620525	1,7	T101BIF	5	83	fijn		6	4 009316 205259



Art.-nr.		BOSCH-nr.	In-houd	Lengte	Snedes			EAN
<b>Universele schacht, professionele verpakking</b>								
620535	1,7	U1BIF	5	70	fijn		6	4 009316 205358



**Decoupeerzaagbladenset, LAMINAAT, houtbewerking, bimetaal**



Decoupeerzaagbladenset, BIM, bimetaal, gehard, tanden kruis- en onder vrije hoek geslepen, snelle zuivere sneden, met priktand voor probleemloos invallend zagen, voor laminaat, platen met kunststof coating, multiplex, hout en hardhout.



Art.-nr.		BOSCH-nr.	Inhoud	Lengte	Snede			EAN
<b>T-schacht</b>								
622320		2x T101BIF + 1x T101AO	3	83	2 x fijn + 1 x curve		10	4 009316 223208

**Decoupeerzaagbladen DIAMANT, tegel- en keramiekbewerking**



Decoupeerzaagbladen DIAMANT, tegel- en keramiekbewerking, met diamant bestrooid, ideaal voor zuivere, rechte sneden in gres, porselein, glas, marmer, leisteen, travertijn, tegels, glasvezel en cement board, kwaliteit van de vakman, voor lange levensduur bij het bouwen en het verbouwen.



Art.-nr.	BOSCH-nr.	Inhoud	Lengte	Snede			EAN
<b>T-schacht</b>							
622220	T150RD	1	83/56	fijn		1	4 009316 222201



**Decoupeerzaagbladen HM, tegel- en keramiekbewerking**



Decoupeerzaagbladen, tegel- en keramiekbewerking, met hard metaal bestrooid, voor wandtegels, keramiek, dakpannen, glas en gietijzer tot een dikte van 15 mm.



Art.-nr.	BOSCH-nr.	Inhoud	Lengte	Snede			EAN
<b>T-schacht</b>							
622121	T150RIFF	1	77/50	fijn		5	4 009316 221211
621921	T130RIFF	1	77/50	grof		5	4 009316 219218

# Decoupeerzaagbladen

## EASY-CUT decoupeerzaagbladen, metaalbewerking, bimetaal



Art.-nr.		BOSCH-nr.	Inhoud	Lengte	Snede			EAN
<b>T-schacht</b>								
624020	1,2-2,6	T123XF	2	100	Fijn-grof		5	4 009316 240205

EASY-CUT decoupeerzaagbladen, BIM, bimetaal, gehard, tanden geschrinkt gefreesd, voor snelle en rechte sneden, progressieve tandverdeling, de afstand tussen de tanden neemt toe van fijn aan het schachtuiteinde tot grof aan de punt, zo is zowel in dikke als dunne materialen altijd een zuivere snijrand verzekerd, voor dun en dik plaatstaal (1,5-10 mm), buizen en profielen in metaal en aluminium tot max. 30 mm.



## Decoupeerzaagbladen, metaalbewerking, bimetaal



Art.-nr.		BOSCH-nr.	Inhoud	Lengte	Snede			EAN
<b>T-schacht</b>								
621120	1,2	T118AF	2	77/50	fijn		10	4 009316 211205
621220	2	T118BF	2	77/50	Medium		10	4 009316 212202
621320	3	T127DF	2	75	grof		10	4 009316 213209

Decoupeerzaagbladen, BIM, bimetaal, zeer elastisch, tanden golvend en gefreesd, voor de bewerking van platen en geperforeerde platen tot 3 mm dik, voor buizen en profielen tot Ø 30 mm, non-ferrometaal, aluminium en plexiglas.



Art.-nr.		BOSCH-nr.	Inhoud	Lengte	Snede			EAN
<b>T-schacht, professionele verpakking</b>								
621125	1,2	T118AF	5	77/50	fijn		6	4 009316 211250
621225	2	T118BF	5	77/50	Medium		6	4 009316 212257
621325	3	T127DF	5	75	grof		6	4 009316 213254



Art.-nr.		BOSCH-nr.	Inhoud	Lengte	Snede			EAN
<b>Universele schacht</b>								
621130	1,2	U118AF	2	70/50	fijn		10	4 009316 211304
621230	2	U118BF	2	70/50	Medium		10	4 009316 212301



**Decoupeerzaagbladen, metaalbewerking, HSS**



Decoupeerzaagbladen, HSS, tanden golvend en gefreesd, voor de bewerking van platen en geperforeerde platen tot 3 mm dik, voor buizen en profielen tot Ø 65 mm, non-ferrometaal, aluminium, sandwichmateriaal en plexiglas.

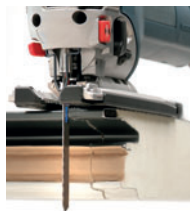

Art.-nr.		BOSCH-nr.	Inhoud	Lengte	Snede			EAN
<b>T-schacht, extra lang</b>								
624220	1,2	T318A	2	132	Medium		5	4 009316 242209

**EASY-CUT decoupeerzaagbladen, UNIVERSEEL, bimetaal**



EASY-CUT decoupeerzaagbladen UNIVERSEEL; BIM, bimetaal, gehard, gefreesd en geschrant, voor snelle en rechte sneden, progressieve tandverdeling, de afstand tussen de tanden neemt toe van fijn aan het schachtuiteinde tot grof aan de punt, zo is zowel in dikke als dunne materialen altijd een nagenoeg zuivere snijrand verzekerd, met priktand voor probleemloos invallend zagen, voor bouw hout met spijkers tot 65 mm dik, houtmateriaal, kunststof, plaatstaal, buizen en profielen van metaal en aluminium tot Ø 10 mm.



Art.-nr.		BOSCH-nr.	Inhoud	Lengte	Snede			EAN
<b>T-schacht</b>								
624820	2,4-5,0	T345XF	2	132/105	Fijn-grof		5	4 009316 248201

**Decoupeerzaagbladenset, 6-delig**



Decoupeerzaagbladenset, 6-delig, 4 bladen voor houtbewerking, HCS-koolstofstaal, gehard, tanden kruis- en onder vrije hoek geslepen, snelle zuivere sneden, met priktand voor probleemloos invallend zagen, voor hout, spaan-, meubel- en vezelplaten en zachte kunststof, 2 bladen voor metaalbewerking, BIM, bimetaal, zeer elastisch, tanden golvend en gefreesd, voor de bewerking van plaatstaal en geperforeerd plaatstaal tot 3 mm dik, voor buizen en profielen tot Ø 30 mm, non-ferrometaal, aluminium en plexiglas, in kunststof doos.



Art.-nr.	Inhoud			EAN
<b>T-schacht, kunststof cassette</b>				
625620	6-delig HCS / houtbewerking, 2 x fijn, 1 x grof, 1 x curve, bimetaal / metaalbewerking, 2 x medium		6	4 009316 256206

# Decoupeerzaagbladen

## Decoupeerzaagbladenset, 6-delig



Art.-nr.	Inhoud			EAN
<b>Universele schacht, kunststof cassette</b>				
625630	6-delig HCS / houtbewerking, 2 x fijn, 1 x grof, 1 x curve, bimetaal / metaalbewerking, 2 x medium		6	4 009316 256305



## Decoupeerzaagbladen, houtbewerking, speciale priktand, HCS-koolstofstaal



Art.-nr.		BOSCH-nr.	Inhoud	Lengte	Snede			EAN
<b>T-schacht</b>								
610120	2	T111B	2	100	fijn		10	4 009316 101209
610220	3	T111C	2	100	Medium		10	4 009316 102206
610320	4	T111D	2	100	grof		10	4 009316 103203
610620	2	T119B0	2	76	Curve		10	4 009316 106204

Decoupeerzaagbladen, HCS-koolstofstaal, gehard, tanden gefreesd en geschrapt, voor zacht hout tot 50 mm dik, spaan-, meubel- en vezelplaten.



Art.-nr.		BOSCH-nr.	Inhoud	Lengte	Snede			EAN
<b>T-schacht, professionele verpakking</b>								
610125	2	T111B	5	100	fijn		6	4 009316 101254
610225	3	T111C	5	100	Medium		6	4 009316 102251
610325	4	T111D	5	100	grof		6	4 009316 103258



Art.-nr.		BOSCH-nr.	Inhoud	Lengte	Snede			EAN
<b>Universele schacht</b>								
610130	2	U111B	2	91	fijn		10	4 009316 101308
610230	3	U111C	2	91	Medium		10	4 009316 102305
610330	4	U111D	2	100	grof		10	4 009316 103302



**Decoupeerzaagbladen, metaalbewerking, HSS**



Decoupeerzaagbladen, HSS-staal, gehard, tanden golvend en gefreesd, voor de bewerking van dun plaatstaal.

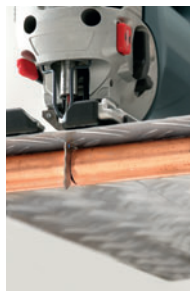

Art.-nr.		BOSCH-nr.	Inhoud	Lengte	Snedes			EAN
<b>T-schacht</b>								
611120		T118G	2	76	fijn		10	4 009316 111208
611220		T118A	2	76	Medium		10	4 009316 112205
611320		T118B	2	76	grof		10	4 009316 113202

Art.-nr.		BOSCH-nr.	Inhoud	Lengte	Snedes			EAN
<b>T-schacht, professionele verpakking</b>								
611225		T118A	5	76	Medium		6	4 009316 112250
611325		T118B	5	76	grof		6	4 009316 113257

Art.-nr.		BOSCH-nr.	Inhoud	Lengte	Snedes			EAN
<b>Universele schacht</b>								
611230		U18A	2	70	Medium		10	4 009316 112304

**Decoupeerzaagbladenset, 10-delig**



Decoupeerzaagbladenset, 10-delig, 8 bladen voor houtbewerking, HCS-koolstofstaal, gehard, tanden gefreesd en geschrapt, voor zacht-hout tot 50 mm dik en spaan-, meubel- en vezelplaten, 2 bladen voor metaalbewerking, tanden golvend en gefreesd, voor de bewerking van dun plaatstaal, in ronde doos waaruit gemakkelijk slechts één blad kan worden gekozen.







Art.-nr.	Inhoud			EAN
<b>T-schacht</b>				
617020	HCS / houtbewerking, 2 x fijn, 2 x medium, 2 x grof, 2 x curve, HSS metaalbewerking 2 x fijn		4	4 009316 170205

Art.-nr.	Inhoud			EAN
<b>Universele schacht</b>				
617030	HCS / houtbewerking, 2 x fijn, 2 x medium, 2 x grof, 2 x curve, HSS metaalbewerking 2 x fijn		4	4 009316 170304



## EASY CUT reciprozaagbladen, houtbewerking, HCS-koolstofstaal





Art.-nr.		BOSCH-nr.	In-houd	Lengte	Snede			EAN
<b>Professionele verpakking</b>								
576900	2,4 - 4,0	S22345X	2	205/180	Fijn-grof		2	

EASY CUT reciprozaagbladen, houtbewerking, HCS-koolstofstaal, gehard, precisiegeslepen en geschrante tanden, progressieve tandverdeling, de afstand tussen de tanden neemt toe van fijn aan het schachtuiteinde tot grof aan de punt, zo is zowel in dikke als dunne materialen altijd een zuivere snijrand verzekerd, voor constructiehout en houten wanden tot 150 mm dik, spaan- en MDF-platen tot 60 mm dik, triplex en kunststof platen tot 100 mm dik, schacht 1/2", voor alle normaal verkrijgbare reciprozagen.



## Reciprozaagbladen, houtbewerking, HCS-koolstofstaal







Art.-nr.		BOSCH-nr.	In-houd	Lengte	Snede			EAN
<b>Hard- en zacht hout, constructiehout, spaanplaten, curve</b>								
576600	4	S644D	2	153/130	Medium		2	

Reciprozaagbladen, houtbewerking, HCS-koolstofstaal, gehard, precisiegeslepen en geschrante tanden, de afstand tussen de tanden neemt toe van fijn aan het schachtuiteinde tot grof aan de punt, zo is zowel in dikke als dunne materialen altijd een zuivere snijrand verzekerd, met priktand, voor probleemloos invallend zagen, voor constructiehout en houten wanden tot 100 mm dik, spaan- en MDF-platen tot 60 mm dik, triplex en kunststof platen tot 100 mm dik, schacht 1/2", voor alle normaal verkrijgbare reciprozagen.



## Reciprozaagbladen, houtbewerking, HCS-koolstofstaal



Art.-nr.		BOSCH-nr.	In-houd	Lengte	Snede			EAN
<b>Hard- en zacht hout, constructiehout, spaanplaten</b>								
576500	4	S1411D	2	305/280	Medium		2	

Reciprozaagbladen, houtbewerking, HCS-koolstofstaal, gehard, precisiegeslepen en geschrante tanden, de afstand tussen de tanden neemt toe van fijn aan het schachtuiteinde tot grof aan de punt, zo is zowel in dikke als dunne materialen altijd een zuivere snijrand verzekerd, met priktand, voor probleemloos invallend zagen, voor constructiehout en houten wanden tot 100 mm dik, spaan- en MDF-platen tot 60 mm dik, triplex en kunststof platen tot 100 mm dik, schacht 1/2", voor alle normaal verkrijgbare reciprozagen.



**Reciprozaagbladen, houtbewerking, HCS-koolstofstaal**



Reciprozaagbladen, houtbewerking, HCS-koolstofstaal, gehard, preciesgeslepen en geschrante tanden, de afstand tussen de tanden neemt toe van fijn aan het schachtuiteinde tot grof aan de punt, zo is zowel in dikke als dunne materialen altijd een zuivere snijrand verzekerd, met priktand, voor probleemloos invallend zagen, voor constructiehout en houten wanden tot 100 mm dik, spaan- en MDF-platen tot 60 mm dik, triplex en kunststof platen tot 100 mm dik, schacht 1/2", voor alle normaal verkrijgbare reciprozagen.



Art.-nr.		BOSCH-nr.	In-houd	Lengte	Snede			EAN
<b>Hard- en zacht hout, bouwhout, brandhout</b>								
576700	8,5	S1111K	2	228/205	grof		2	4 009315 767000

**Reciprozaagbladen, houtbewerking, HCS-koolstofstaal**

Reciprozaagbladen, houtbewerking, HCS-koolstofstaal, gehard, preciesgeslepen en geschrante tanden, schacht 1/2", voor alle normaal verkrijgbare reciprozagen, speciaal voor brandhout, vochtig en droog hout tot 190 mm dik, bouwhout en hardhout.



Art.-nr.		BOSCH-nr.	In-houd	Lengte	Snede			EAN
<b>Hard- en zacht hout, bouwhout, droog brandhout</b>								
576300	8,5	S1542K	2	240/218	extra grof		2	4 009315 763002

**Reciprozaagbladen, houtbewerking, HCS-koolstofstaal**





Reciprozaagbladen, houtbewerking, HCS-koolstofstaal, gehard, preciesgeslepen en geschrante tanden, groepvertanding, schacht 1/2", voor alle normaal verkrijgbare reciprozagen, speciaal voor levend hout, snoeien tot ø 190 mm, brandhout, vochtig en droog hout, bouwhout en hardhout.



Art.-nr.		BOSCH-nr.	In-houd	Lengte	Snede			EAN
<b>Hard- en zacht hout, bomensnoei, vochtig brandhout, groepvertanding</b>								
576400	5	S1531L	2	240/218	grof		2	4 009315 764009

Reciprozaagbladen, multifunctioneel, HAS-staal



Art.-nr.		BOSCH-nr.	In-houd	Lengte	Snede			EAN
<b>Hout, hout met spijkers, non-ferrometaal, gipsplaat</b>								
578400	2,5	S811H	2	153/130	Medium		2	

HAS-staal voor houtbewerking en non-ferrometaalbewerking.



## kwb-info

### Een kwestie van veiligheid

Veiligheidshandschoenen dienen te worden gedragen bij alle toepassingen waarbij handletsels kunnen optreden, bijv. in de bouw, bij voorwerpen met scherpe randen enz.

Bij alle werkzaamheden zijn grip en optimaal draagcomfort basisvoorwaarden voor de juiste veiligheidshandschoenen.

Alle informatie hierover vindt u in onze kwb-folder voor arbeidsveiligheid of op het internet op [www.kwb.eu](http://www.kwb.eu)



**EASY CUT reciprozaagbladen, metaalbewerking, bimetaal**



EASY CUT reciprozaagbladen, metaalbewerking, BIM, bimetaal, gehard, tanden geschrinkt gefreesd, schacht 1/2", voor alle normaal verkrijgbare reciprozagen, voor snelle rechte sneden, progressieve tandverdeling, de afstand tussen de tanden neemt toe van fijn aan het schachtuiteinde tot grof aan de punt, zo is zowel in dikke als dunne materialen altijd een zuivere snijrand verzekerd, voor dunne en dikke platen tot 8 mm dik, buizen, sterke profielen tot ø 100 mm.

Art.-nr.		BOSCH-nr.	In-houd	Lengte	Snede			EAN
<b>Dun en dik metaal, zuivere snede</b>								
579900	1,75 - 3,0	S123XF	2	153/130	Fijn-grof		2	4 009315 799001



**Reciprozaagbladen, metaalbewerking, bimetaal**



Reciprozaagbladen, metaalbewerking BIM, bimetaal, zeer elastisch, tanden gefreesd en geschrinkt, schacht 1/2", voor hout met spijkers, metaal met een dikte tot 150 mm, reparatie van pallets, metalen platen, buizen en aluminiumprofielen met een dikte tot 12 mm, door de flexibiliteit zijn vlakke sneden mogelijk

Art.-nr.		BOSCH-nr.	In-houd	Lengte	Snede			EAN
<b>Plaatstaal, buizen, profielen, kunststof, hout met spijkers, flexibel</b>								
577800	2,5	S1022HF	2	205/180	Medium		2	4 009315 778006

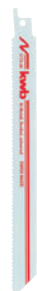
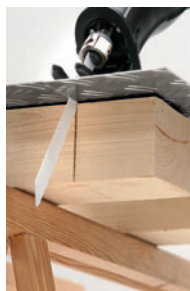

**Reciprozaagbladen, metaalbewerking, bimetaal**



Reciprozaagbladen, metaalbewerking BIM, bimetaal, zeer elastisch, tanden gefreesd en geschrinkt, schacht 1/2", voor hout met spijkers, metaal met een dikte tot 150 mm, reparatie van pallets, metalen platen, buizen en aluminiumprofielen met een dikte tot 12 mm, door de flexibiliteit zijn vlakke sneden mogelijk

Art.-nr.		BOSCH-nr.	In-houd	Lengte	Snede			EAN
<b>Staal, zacht staal, profielen, plaatstaal, aluminium, kunststof</b>								
577500	1,4	S918EF	2	153/130	fijn		2	4 009315 775005
579100	2	S922BF	2	153/130	Medium		2	4 009315 791005
577400	2,5	S918HF	2	153/130	grof		2	4 009315 774008



# Reciprozaagbladen

## Reciprozaagbladen, metaalbewerking, bimetaal



Art.-nr.		BOSCH-nr.	Inhoud	Lengte	Snede			EAN
<b>Staal, zacht staal, non-ferrometaal, aluminium, profielen, buizen, flexibel</b>								
579500	2	S1122BF	2	228/205	Medium		2	4 009315 795003

Reciprozaagbladen, metaalbewerking BIM, bimetaal, zeer elastisch, tanden gefreesd en geschrant, schacht 1/2", voor hout met spijkers, metaal met een dikte tot 150 mm, reparatie van pallets, metalen platen, buizen en aluminiumprofielen met een dikte tot 12 mm, door de flexibiliteit zijn vlakke sneden mogelijk



## EASY CUT reciprozaagbladen, UNIVERSEEL, bimetaal



Art.-nr.		BOSCH-nr.	Inhoud	Lengte	Snede			EAN
<b>Hout met spijkers, metaal, staalplaat, buizen, aluminium profielen, kunststof</b>								
578900	8,2 - 4,6	S3456XF	2	205/180	Fijn-grof		2	4 009315 789002

EASY CUT reciprozaagbladen, UNIVERSEEL, BIM, bimetaal, gehard, tanden geschrant gefreesd, schacht 1/2", voor alle normaal verkrijgbare reciprozagen, voor hout met spijkers, metaal, spaanplaten met een dikte tot 150 mm, metalen platen, buizen, profielen en aluminiumprofielen met een dikte tot 18 mm, glasvezelversterkte kunststof met een dikte tot 150 mm.

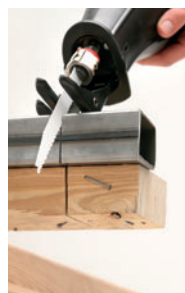

## Reciprozaagbladen DIAMANT, tegel- en keramiekbewerking



Art.-nr.	BOSCH-nr.	Inhoud	Lengte	Snede			EAN
578300	S1050RD	1	200	Medium		1	4 009315 783000

Reciprozaagbladen DIAMANT, tegel- en keramiekbewerking, met diamant bestrooid, ideaal voor zuivere, rechte sneden in gres, porselein, glas, marmer, leisteen, travertijn, tegels, glasvezel en cement board, kwaliteit van de vakman, voor lange levensduur bij het bouwen en het verbouwen.



**Cellenbetonzaagbladen**



De ideale oplossing om cellenbeton, vezelcement en rode dakpannen zuiver te snijden.



Art.-nr.	Inhoud			EAN
577100	9" x 240 mm		1	4 009315 771007

**Cellenbetonzaagbladen**



De ideale oplossing om cellenbeton, vezelcement en rode dakpannen zuiver te snijden.



Art.-nr.		BOSCH-nr.	In-houd	Lengte	Snede			EAN
577300	12,7	S2243HM	1	455/400	grof		1	4 009315 773001

## Multitool-toebehoren

### Invalzaagblad met Japan-vertanding, CV



Voor bijzonder zuivere en snelle sneden tot 48 mm diep (34 mm breed) in hardhout, zachthout, gipsplaten, laminaat, parket, kunststof enz. Eenvoudig invallend zagen op elk plek in het materiaal, bijv. in parketvloeren, in echt houten keukenwerkbladen voor ventilatieroosters, in kasten of gipsplaten voor stopcontacten.





Art.-nr.	Inhoud			EAN
709164	Invalzaagblad voor hout, met Japan-vertanding		10	4 009317 091646



### Invalzaagblad voor hout, CV



Zaagt hout tot 28 mm (10 mm), 48 mm (22 mm, 34 mm) voor hout, gipsplaat en zachte materialen. Eenvoudig invallend zagen op elk plek in het materiaal, geschikt voor hout, platen, laminaat, parket en kunststof, bijv. probleemloos invallend zagen in keukenwerkbladen voor ventilatieroosters, in kasten of gipsplaten voor stopcontacten.





Art.-nr.	Inhoud			EAN
709140	CRV-invalzaagblad voor hout, 10 mm		1	4 009317 091400
709142	CRV-invalzaagblad voor hout, 22 mm		1	4 009317 091424
709144	CRV-invalzaagblad voor hout, 34 mm		1	4 009317 091448



### Universeel invalzaagblad voor metaal en hout, bimetaal



Zaagt gecoat hout tot 50 mm. Eenvoudig invallend zagen op elk plek in het materiaal, geschikt voor kunststof, fiberglas, staalplaat tot 2 mm, koperen buizen, aluminium buizen en profielen, bijv. om uitstekende spijkers in hout of uitstekende koperen buizen in muren gelijk met het oppervlak af te zagen. Probleemloos invallend zagen in keukenwerkbladen voor ventilatieroosters, in kasten of gipsplaten voor stopcontacten. Moeiteloos zagen in fiberglas bij scheepsbouw of in kunststof elementen. Eenvoudig uitsnijdingen maken in dunne staalplaten en non-ferrometalen.

Art.-nr.	Inhoud			EAN
709240	Invalzaagblad voor metaal, 10 mm		1	4 009317 092407
709242	Invalzaagblad voor metaal, 22 mm		1	4 009317 092421



**Invalzaagblad, halfrond, HSS**



Zaagt gecoat hout tot 50 mm. Eenvoudig invallend zagen op elk plek in het materiaal, geschikt voor kunststof, fiberglas, staalplaat tot 2 mm, koperen buizen, aluminium buizen en profielen, bijv. om uitstekende spijkers in hout of uitstekende koperen buizen in muren gelijk met het oppervlak af te zagen. Probleemloos invallend zagen in keukenwerkbladen voor ventilatieroosters, in kasten of gipsplaten voor stopcontacten. Moeiteloos zagen in fiberglas bij scheepsbouw of in kunststof elementen. Eenvoudig uitsnijdingen maken in dunne staalplaten en non-ferrometalen.



Art.-nr.	Inhoud			EAN
709440	Invalzaagblad, HSS, 80 mm		10	4 009317 094401

**Zaagblad, halfrond, HM**



Freest voegen van tegels met een snijbreedte van 2,2 mm en een snijdiepte tot 85 mm. Ideaal voor werkzaamheden in hoeken, invallend zagen in het materiaal en werkzaamheden op egale oppervlakken.

Bijv. beschadigde voegen bij tegels verwijderen, beschadigde tegels vervangen, sleuven frezen in kalkzandsteen of cellenbeton voor kabelkanalen of kokers frezen voor inbouw.



Art.-nr.	Inhoud			EAN
709542	Zaagblad, HM, 85 mm		10	4 009317 095422

**Diamantzaagblad, halfrond**



Freest voegen van tegels met een snijbreedte van 1,3 mm en een snijdiepte tot 12 mm. Ideaal voor werkzaamheden in hoeken, invallend zagen in het materiaal en werkzaamheden op egale oppervlakken.

Bijv. beschadigde voegen bij tegels verwijderen, beschadigde tegels vervangen, precieze kleine uitsnijdingen maken in zachte tegels voor buisaansluitingen of hoeken, sleuven frezen in kalkzandsteen of cellenbeton voor kabelkanalen of kokers frezen voor inbouw.



Art.-nr.	Inhoud			EAN
709546	Diamantzaagblad, 65 mm		10	4 009317 095460







## Multitool-toebehoren

### HM-rasp, delta



Schuurt en verwijdert mortel, tegellijm en tapijtresten. Ook geschikt voor grof schuren en gladmaken van plamuur, tegellijm, beton, steen, hout, bijv. mortel of tegellijm van kapotte tegels verwijderen, vastgeplakte tapijtresten verwijderen of beton, steen en hout grof voorschuren. Ideaal voor zowel op vlakken, als in hoeken, nauwe spleten en op randen. Geschikt voor gebruik met machines met en zonder stofafzuiging.





Art.-nr.	Inhoud			EAN
709544	HM-rasp, delta, 80 mm		10	 4 009317 095446



### Schraapstaal, hard



Ideaal voor zowel op vlakken, als in hoeken, nauwe spleten en op randen. Geschikt voor gebruik met machines met en zonder stofafzuiging.





Art.-nr.	Inhoud			EAN
709640	Schraapstaal, hard		10	 4 009317 096405



### Schraapstaal, flexibel



Om zachte materialen af te schrapen, zoals siliconen- of acrylvoegen, lijmresten van stickers, verfresten, bijv. verwijderen van tapijtljmresten die blijven zitten bij tapijtruggen van zacht schuimrubber, oude of beschadigde siliconen- of acrylvoegen of loszittende verfresten op hout en metaal.

Art.-nr.	Inhoud			EAN
709642	Schraapstaal, flexibel		10	 4 009317 096429



**Houderplaat, delta-hechtpad, geperforeerd, 93 mm**



Snelle en eenvoudige wissel van schuurpapier met afzuiging, schuurvlies of vilten polijstschijs met QUICK-STICK-klittenbandbevestiging. Geschikt toebehoren in het kwb-programma: korund-schuurpapier voor hout en metaal met verschillende korrelgrootten, Silberschliff-schuurpapier voor hout en verf, schuurvlies om materialen te matteren en houtvezels glad te maken, vilten polijstschijs voor het polijsten van hout, metaal en non-ferrometaal.

Art.-nr.	Inhoud			EAN
709940	Houderplaat, delta-hechtpad, 93 mm		10	4 009317 099406



**Tegelreparatieset, 3-delig**



Universeel bruikbaar voor reparaties en vervangingen van mortel en tegels Bijv. beschadigde voegen bij tegels verwijderen, beschadigde tegels vervangen, precieze kleine uitsnijdingen maken in zachte tegels voor buisaansluitingen of hoeken, mortel of tegellijm van kapotte tegels verwijderen, vastgeplakte tapijtresten verwijderen of beton, steen en hout grof voorschuren. Sleuven frezen in kalkzandsteen of cellenbeton voor kabelkanalen of kokers frezen voor inbouw.

Art.-nr.	Inhoud			EAN
708600	65 mm half rond HM-bestrooid, 80 mm delta HM-bestrooid, 65 mm half rond met diamant bestrooid		10	4 009317 086000

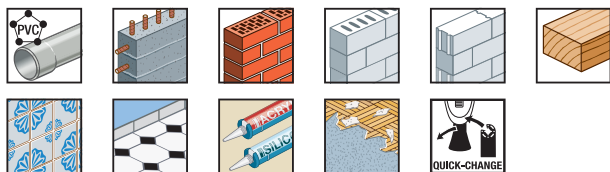

**Vloer- en inbouwset, 4-delig**



Universeel bruikbaar voor hout- en reparatiewerkzaamheden Bijv. zuiver op maat zagen van parket, laminaat of geluidsisolatieplaten, deurlijsten exact gelijk met de vloer afzagen bij het leggen van parket, inkorten van aluminium verbindingsrails, uitstekende spijkers in hout of uitstekende koperen buizen in muren gelijk met het oppervlak afzagen. Probleemloos invallend zagen in keukenwerkbladen voor ventilatieroosters, in kasten of gipsplaten voor stopcontacten. Moeiteloos zagen in fiberglas bij scheepsbouw of in kunststof elementen. Probleemloos verwijderen van oude kit bij ramen. Eenvoudig uitsnijdingen maken in dunne staalplaten en non-ferrometalen.

Verwijderen van tegellijmresten bij reparatiewerkzaamheden, beton- of mortelresten bij metselwerkzaamheden, lijmresten na de verwijdering van vast tapijt, oude verf en onder-vloerlagen.

Art.-nr.	Inhoud			EAN
708800	87 mm half rond HSS-zaag, 28 x 48 mm houtzaagblad CV, 22 x 48 mm metaalzaagblad BIM, 26 x 52 mm plamuurmes		10	4 009317 088008

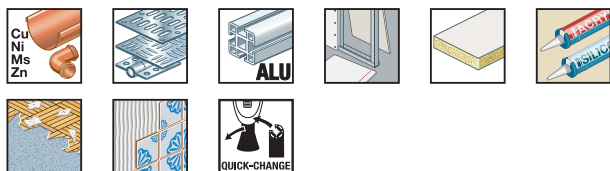

## Multitool-toebehoren

### Universele adapter, OMT



Met de universele adapter passen de allrounder/multitool-toebehoren van kwb op talrijke gangbare multicutters, allrounders of multifunctionele gereedschappen. De universele adapter kan met de volgende elektrische gereedschappen worden gebruikt:

Bosch PMF 180 E, GOP 10.8 V-Li, EINHELL RT-MG 200 E RED, RT-MG 108 Li RED, BT-MG 220 E, BT-MG 180, DREMEL Multi-Max, ERGOTOOLS Plattfield E-MG 250 E, LUX TOOLS AMF 12 Li, Mac Alister MMT108, PARKSIDE, FEIN Multimaster Ø 10 mm, Rockwell/Works Sonicrafter, Craftsman Multi-Tool, Mastercraft Multi-Cutter.



Art.-nr.	Inhoud			EAN
708700	Universele OMT-adapter		10	 4 009317 087007



### Universele set, 17-delig



Universeel bruikbaar voor hout-, schuur- en reparatiewerkzaamheden. Bijv. zuiver op maat zagen van parket, laminaat of geluidsisolatieplaten, deurlijsten exact gelijk met de vloer afzagen bij het leggen van parket, inkorten van aluminium verbindingrails, uitstekende spijkers in hout of uitstekende koperen buizen in muren gelijk met het oppervlak afzagen. Probleemloos invallend zagen in keukenwerkbladen voor ventilatieroosters, in kasten of gipsplaten voor stopcontacten. Moeiteloos zagen in fiberglas bij scheepsbouw of in kunststof elementen. Probleemloos verwijderen van oude kit bij ramen.

Eenvoudig uitsnijdingen maken in dunne staalplaten en non-ferrometalen. Verwijderen van tegellijmresten bij reparatiewerkzaamheden, beton- of mortelresten bij metselwerkzaamheden, lijmresten na de verwijdering van vast tapijt, oude verf en ondervloerlagen. Schuren van hout en verf, matten en gladmaken van houtvezels, polijsten van hout, metaal en non-ferrometaal.

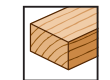





















































Art.-nr.	Inhoud			EAN
708900	87 mm half rond HSS-zaag, 28 x 48 mm houtzaagblad CV, 93 mm klittenbandpad, 6 stuks zelfhechtende schijven hout + verf, 22 x 48 mm metaalzaagblad BIM, 26 x 52 mm plamuurmes, 6 stuks zelfhechtende schijven hout en metaal		10	 4 009317 089001

... altijd de passende toebehoren voor uw machine!

Fabrikant/machinetype	Machine-houder	Adapter-houder	+	kwb Multitool Quick Change	=	past!
<b>AEG</b> BWS 12 C			+		=	
<b>ALDI (Workzone/Topcraft)</b>			+		=	
<b>ALPHA TOOLS</b> A180			+		=	
<b>BATAVIA</b> ZZ 9506, TD 8501			+		=	
<b>BLACK &amp; DECKER</b> MT250KA, MT300KA, BD200MTB			+		=	
<b>BOSCH</b> PS50-2A, MX25EC-21, PMF 180 E, PMF 190 E, PMF 10,8 Li, PMF 250 CES, GOP 250 CE			+		=	
<b>CRAFTSMEN</b> Nextec 5910 12 V, Nextec 174J8			+		=	
<b>CRAFTSMEN</b> Craftsman G2 Cordless Nextec Tool-Free Multitool #67537 Variable Speed Oscillating Multifunction Power Tool #67256 base model fixed speed Oscillating Multifunction Power Tool #67707 12 Volt Lithium-Ion Oscillating Multifunction Power Tool #67538 Variable Speed Multifunction Air Tool #68303 Fixed speed Oscillating Multifunction Power Tool #68861 Fixed speed Oscillating Multifunction Power Tool			+		=	
<b>DREMEL</b> MM20, Multi-Max TM 8300-q, MM40 (Quick Change)			+		=	
<b>EINHELL</b> RT-MG 200 E, RT-MG 10.8Li, BT-MG 180, BT-MG 220 E			+		=	
<b>ERGOTOOLS</b> Pattfield E-119 250 E			+		=	
<b>FEIN MULTIMASTER</b> FMM 250			+		=	
<b>FERM</b> OTM-1001, OTM-1003			+		=	
<b>LIDL (PARKSIDE)</b> PMFV 280			+		=	
<b>LIDL (PARKSIDE)</b> PMFV 280 A2, PDMT 6.2 A1			+		=	

# Multitool-toebehoren

Fabrikant/machinetype	Machine-houder	Adapter-houder	+	kwb Multitool Quick Change	=	past!
<b>LUX TOOLS</b> AMF 12 Li, MFW 220		 <small>Adapter van uw machine</small>	+		=	
<b>MAC ALLISTER</b> 2426-22MM12, MMT 108		 <small>Adapter van uw machine</small>	+		=	
<b>MAKITA</b> BTM40, BTM50			+		=	
<b>MASTERCRAFT</b> BWS 12 C			+		=	
<b>MEISTER BASIC</b> BMT-250			+		=	
<b>MILWAUKEE</b> 2426-22MM12			+		=	
<b>PORTER CABLE</b> 250MT, PC250MTK, PCL120MT, PCE605, PCCK510LA, PCC510B	 <small>Quick Change</small>	 <small>Adapter van uw machine</small>	+		=	
<b>RIGID</b> JobMax			+		=	
<b>ROCKWELL</b> RK5100K, RK5101K, RK5102K, RK5105K, RK5106K, RK5107K, RK5108K		 <small>Adapter van uw machine</small>	+		=	
<b>RYOBI</b> RMT 12011 L, RMT 18011 L, RMT 1801 M		 <small>Adapter van uw machine</small>	+		=	
<b>SKIL</b> Multi-Tasker 147D, 1400 2.0 Amp, 1470 AA			+		=	
<b>STANLEY FATMAX</b> FME600 Oscillating Tool, FME600K Oscillating Tool Kit	 <small>Quick Change</small>	 <small>Adapter van uw machine</small>	+		=	
<b>WESTFALIA</b> TD 8501			+		=	
<b>WORX</b> Worx 250W Sonicrafter WX671, Worx 12V Sonicrafter, Worx Sonicrafter Pro 250 W, Worx Sonicrafter Pro 12V Li WX673		 <small>Adapter van uw machine</small>	+		=	
<b>KWB-ADAPTER (708700)</b> Geschikt voor vele machinetypes. Bevat twee verschillende adapters.		 <small>kwb-adapter</small>	+		=	

... altijd de passende toebehoren voor uw machine!



# CIRKELZAAG- BLADEN

EASY CUT

 kw b

max. 7000 R.P.M.

x24

TCT

PVC

ALU

fein

fein

fein

fein

fein

fein

fein

fein

fein

fein

fein

fein

fein

fein

fein

fein

fein

fein

fein

fein

fein

fein

fein

fein

fein

fein

fein

fein

fein

fein

fein

fein

fein

fein

fein

fein

fein

fein

fein

fein

fein

fein

fein

## Cirkelzaagbladen



Zoek en vind eenvoudig en snel het juiste cirkelzaagblad in onze uitgebreide machinewijzer.

### Zoekt u de fabrikant of het machinetype?

Kijk dan op pagina 250 - 259.

### Zoekt u de juiste maat?

- voor handcirkelzagen pagina 260 - 267
- voor bouw- en tafelcirkelzagen pagina 268 - 274
- voor kap- en verstekzagen pagina 275 - 276

## Programma overzicht en kwaliteit



### EASY CUT universeel blad, Ø 150 - 350 mm ★★★★★

Met hardmetaal versterkt, precieze en zuivere snede. Speciaal afwisselend getand, voor handcirkelzagen, bouw- en tafelcirkelzagen en kap- en verstekzagen. Asymmetrische tandverdeling voor een geluidsreductie van min. 30%. Voor spaanplaat, bouwhout, metalen en aluminium profielen en kunststof incl. plexiglas.

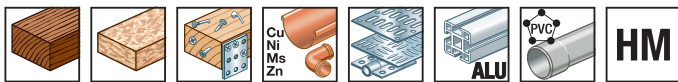

### Precisieblad, Ø 125 - 230 mm ★★★★★

Met hardmetaal versterkt, snelle fijne sneden met zuivere snijranden. Fijn getand, voor handcirkelzagen. Voor massief hout, spaanplaat met coating (werk- en keukenwerkbladen), meubel-, spaan- en hardvezelplaten en glasvezelversterkte kunststof.

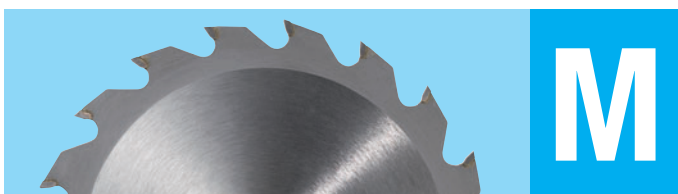
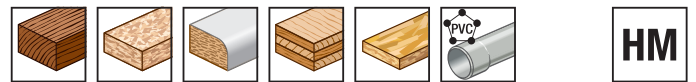

### Zaagblad voor spaanplaat, Ø 125 - 230 mm ★★★★★

Met hardmetaal versterkt, snelle en zuivere snede. Normaal getand, voor handcirkelzagen. Voor massief hout, spaanplaten met coating (werk- en keukenwerkbladen), meubel-, spaan- en hardvezelplaten en glasvezelversterkte kunststof.

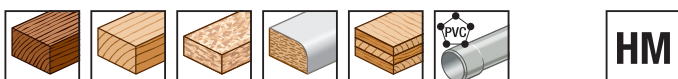

### Zaagblad voor bouwhout Ø 250 - 500 mm ★★★★★

Met hardmetaal versterkt, snelle en grove snede. Grof getand, voor bouw- en tafelcirkelzagen. Voor massief hout, meubel-, spaan- en hardvezelplaten en glasvezelversterkte kunststof.

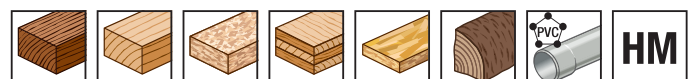



## kwb-info

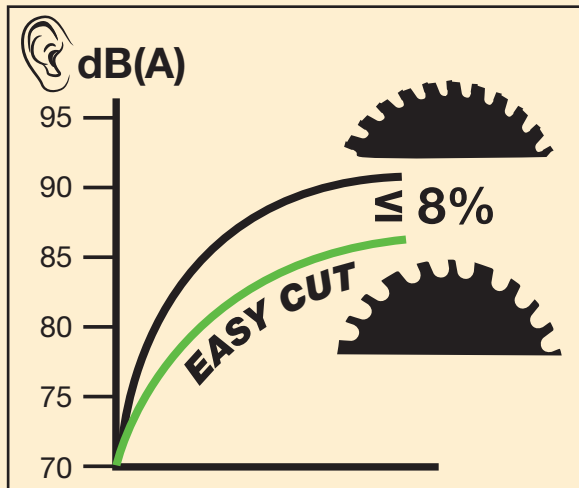

## EASY CUT stil universeel cirkelzaagblad

- Asymmetrische vertanding
- Trillingsvrij werken
- Minder terugslagen bij het zagen
- Veilig werken met geringe belasting van de gewrichten
- Zuivere, perfecte snede
- Tot 30 % stiller

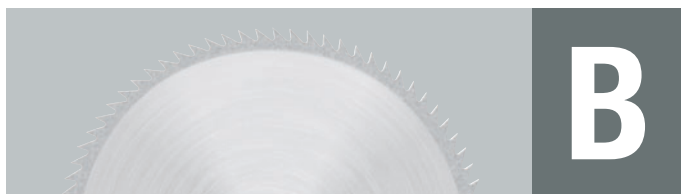

### Zaagblad voor profielhout, Ø 125 - 500 mm ★★★★★

Chroom-vanadium, fijne en precieze snede. Spits getand, voor handcirkelzagen en bouw- en tafelickeelzagen. Voor zacht hout, multiplex, panelen en profielschroten.

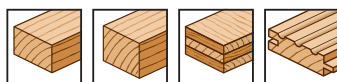

CV



### Zaagblad voor brandhout, Ø 250 - 500 mm ★★★★★

Chroom-vanadium, snelle en grove snede. Grof getand, voor bouw- en tafelickeelzagen. Voor brandhout, bouwhout en planken.

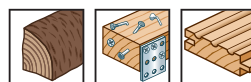

CV



### Zaagblad voor profielhout, Ø 210 - 300 mm ★★★★★

Chroom-vanadium, fijne en precieze snede. Fijn getand, voor kap- en verstekzagen. Voor zacht hout, multiplex, panelen en profielschroten.

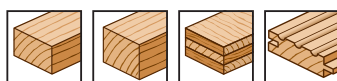

CV

## kwb-info

CV

### Chroom-vanadium

Bijzonder goed geschikt voor overlangse en dwarse sneden in natuur- en gelaagd hout. Voor eenvoudige en zuivere sneden.

HM

### Met hardmetaal versterkt

Bijzonder belastbaar en langer scherp. Hoe meer tanden het zaagblad heeft, hoe fijner de snede.

Fabrikant/machinetype	Blad Ø mm	Gat Ø mm	Gebruik							kwb- code	Art.-nr.
			E	P	M	K	B	C	A		
<b>AEG</b>											
<b>Handcirkelzagen</b>											
HK 125, 125A, 125B, 125H	125	20		✓						13	5813
HK 40	140	20		✓						28	5828
HK 45, 45A, 46, 46N, 46S, HK 50, 52, 737, HKS 52	150	20	✓		✓		✓			35	5835
AHK 52 Akku	150	20	✓		✓		✓			35	5835
HK 55A, 55B, 160A, 160B, K 55, 55S, 55SE	160	20	✓		✓		✓			45	5845
HK 65, 65A, 66, 190, HKS 65, 65A, 66, HKE 66, K 66SE	190	30	✓		✓		✓			69	5869
HKSE 66, KS 66S, K 66S	190	30	✓		✓		✓			69	5869
HK 200, 201	200	30	✓				✓			74	5874
HK 75, 75A, HKS 75	210	30	✓	✓	✓		✓			78	5878
35, HKS 85	230	30	✓				✓			85	5885
<b>Bouw- en tafelcirkelzagen</b>											
M 65	250	30	✓		✓	✓	✓	✓		93	5893
<b>AL-KO</b>											
<b>Bouw- en tafelcirkelzagen</b>											
Holzmeister H, S, NHS, HS/3, HS/4	315	30	✓		✓	✓	✓	✓		931	5931
W 450	450	30				✓	✓	✓		945	5945
W 500, W 50 Profi	500	30				✓	✓	✓		951	5951
<b>ALPHA TOOLS</b>											
<b>Handcirkelzagen</b>											
KS 210 / 2 Profi	210	30	✓	✓	✓		✓			78	5878
<b>ATIKA</b>											
<b>Bouw- en tafelcirkelzagen</b>											
ATK 315H, BTA 90, HAT 315	315	30	✓		✓	✓	✓	✓		931	5931
ABH 400, ABK 400	400	30				✓	✓	✓		940	5940
ABH 450, ATU, BWK 450, ABK 450	450	30				✓	✓	✓		945	5945
ABH 500, BWK 500, ABK 500	500	30				✓	✓	✓		951	5951
<b>BLACK &amp; DECKER</b>											
<b>Handcirkelzagen</b>											
DN 254, 55, 56, D 984, 985, D 2702, 2712	127	12,75			✓		✓			15	5815
BD 227, 228, 846, DN 227, DN 227H, KS 846, 840	140	12,75			✓		✓			23	5823
P 88-09	150	20	✓		✓		✓			35	5835
BD 228, 228CK, 2288L, SR 352, DN 228, 57, SR 352E, P 36-01	156	12,75	✓				✓			41	5841
BD 855, U 336, 975, 976, KS 855, 855N, GKS 54CE	160	16	✓		✓		✓			43	5843
M 336, 975, 976	160	16	✓		✓		✓			43	5843
HD 1200, 2062	180	20	✓		✓		✓			57	5857
BD 229, 865E, DN 229, 59, 820, HD 100, 1000, 1200P	184	16	✓	✓	✓		✓			61	5861
KS 865, 865KN, 865E, GD 60, P 37-03, 37-05, SEC 718,	184	16	✓		✓		✓			61	5861
2062, SR 300, 362E	184	16	✓		✓		✓			61	5861
BD 365	190	30	✓		✓		✓			69	5869
U 338, M 338	200	16	✓		✓		✓			71	5871
BD 800, 88, DN 800, 810, HD 2075S, KS 805, 810, 800,	210	30	✓	✓	✓		✓			78	5878
PS 174, P 38-02, SEC 818, SR 700	210	30	✓	✓	✓		✓			78	5878
HD 2086S, P 39-02, SEC 918	230	30	✓				✓			85	5885
<b>Cirkelzaagbladen voor handcirkelzagen</b>											
BD 800, SR 700, KS 810, KS 800, HD 20755, KS 810 A	210	30	✓	✓						78	5878

# Cirkelzaagbladen volgens fabrikant/machinetype

Fabrikant/machinetype	Blad Ømm	Gat Ømm	Gebruik							kwb-code	Art.-nr.
			E	P	M	K	B	C	A		
<b>BOSCH</b>											
<b>Handcirkelzagen</b>											
PKS 40, 40S, S 43	130	16			✓		✓			18	5818
1551, 1559	140	20		✓						28	5828
GKS 12V Akku, PKS 416, GKS 12	150	16		✓	✓		✓			33	5833
GB 1923, PKS 46, S 1, S 33	150	16	✓	✓	✓		✓			33	5833
GKS 54, 54CE, 54C, PKS 54, 54CE	160	16	✓		✓		✓			43	5843
GKS 55, 55CE, PKS 55 A	160	20	✓		✓		✓			45	5845
1552, 1556, 1563, GKS 55	170	30	✓				✓			54	5854
0550, 1550, 1553, 1557, 1560	180	30		✓	✓		✓			59	5859
P 30, 300, PKS 65	190	16	✓		✓		✓			65	5865
0051, 1553, 1564, PKS 66, 66CE, 66 A, 66 AF, GKS 65, 65CE	190	30	✓	✓	✓		✓			69	5869
GKS 66, 66CE, 68BC, 68B, P 30	190	30	✓	✓	✓		✓			69	5869
0551, 1561	200	30	✓				✓			74	5874
1554, 1558, 1565, 1588, GKS 75S	210	30	✓	✓	✓		✓			78	5878
0052, 1562, 1566, 0552, 1662, GKS 85 (235mm), 85S	230	30	✓				✓			85	5885
<b>Bouw- en tafelcirkelzagen</b>											
PTS 10, 10T, GTS 10	254	30	✓		✓		✓	✓		93	5893
<b>Cirkelzaagbladen voor handcirkelzagen</b>											
GCM 8S	216	30								82	5882
GCM 10SD, 10S, 10	254	30	✓							94/93	5894
GCM 12SD, 12, GTM 12	305	30	✓						✓	930	5930
<b>DEWALT</b>											
<b>Handcirkelzagen</b>											
DW 62	184	16	✓		✓		✓			61	5861
DW 65	190	30	✓		✓		✓			69	5969
<b>Bouw- en tafelcirkelzagen</b>											
DW 110 *1), DW 111 *1), DW 125 *1), DW 150, DW 744 *1), *1) Red Ring 30 x 16	250	30	✓		✓	✓	✓	✓		93	5893
DW 250, DW 252, DW 320	250	30	✓		✓	✓	✓	✓		93	5893
DW 12 *2), DW 1370, 142 DS, 160 DS, 1635/4L, 3L, *2) Red Ring 30 x 20	300	30	✓			✓	✓	✓		930	5930
1653/3L, 1875, 2155, DW 810	300	30	✓			✓	✓	✓		930	5930
C 14	350	30	✓			✓	✓	✓		935	5935
163546+62, 2155-4+6	400	30				✓	✓	✓		940	5940
1420 S, 1600S, 1635/4L, 1635/6L, 6K, 1875, 2155/4+6	500	30				✓	✓	✓		951	5951
DA 1420S, DA 1600S, DA 1635/54L, DA 1635/6L	500	30				✓	✓	✓		951	5951
<b>Cirkelzaagbladen voor handcirkelzagen</b>											
DW 110, DW 111, DW 125, DW 150	250	16								95	5895
DW 250, DW 252, DW 320, DW 710	250	30	✓							94/93	5894
DW 810, DW 1370, 1420S, 1600S, 1635/4L, 1875	300	30	✓						✓	930	5930
2155/4, DW 704, DW 705	300	30	✓						✓	930	5930
1420S, 1600S, 1635/4L, 1875, 2155/4	350	30	✓							935	5935
<b>EINHELL</b>											
<b>Handcirkelzagen</b>											
HES 160, BT-CS 1200	160	20	✓		✓		✓			45	5845
RT-CS 165 Red-Ring 20 x 16	165	20	✓							48	5848
BT-CS 1400	190	20	✓		✓		✓			67	5867
RT-CS 190L	190	30	✓		✓		✓			69	5969
BT-TS 800	200	16	✓		✓		✓			71	5871
RT-TS 1221	210	30	✓	✓	✓		✓			78	5878

Fabrikant/machinetype	Blad Ø mm	Gat Ø mm	Gebruik							kwb- code	Art.-nr.
			E	P	M	K	B	C	A		
<b>EINHELL</b>											
<b>Bouw- en tafelcirkelzagen</b>											
BT-TS 1500 U, RT-TS 1825U, RT-TS 1725 U	250	30	✓		✓	✓	✓	✓		93	5893
BT-TS 2031 Z, RT-TS 2031 U, RT-TS 2231 DU	315	30	✓			✓	✓	✓		931	5931
<b>Cirkelzaagbladen voor handcirkelzagen</b>											
BT-MS 210 T, BT-MS 210, BT-SM 2050, RT-SM 305 L	210	30	✓							78	5878
KGTN 250, KGTN 245, BT-MS 250 T, BT-SM 3100	250	30	✓							94/93	5894
BT-MS 250 L, RT-SM 430 U	250	30	✓							94/93	5894
<b>ELEKTRA-BECKUM</b>											
<b>Handcirkelzagen</b>											
PK 200, P 200, UK 200 W, UK 200E	210	30	✓	✓	✓		✓			78	5878
<b>Bouw- en tafelcirkelzagen</b>											
KS 250, KS 304, PK 3100 WN/250, PK 4200 DN/250	250	30	✓		✓	✓	✓	✓		93	5893
PK 6000 DN/250, DN 4200, PK 255 TOP LINE	250	30	✓		✓	✓	✓	✓		93	5893
PKF 255 V8, PKF 255 Profi Line, UK 250 Profi Line	250	30	✓		✓	✓	✓	✓		93	5893
UK 330 Profi Line	250	30	✓		✓	✓	✓	✓		93	5893
1800, 2200, 2800, 3100, 4100, Combi HS 315, TKHS 315	315	30	✓			✓	✓	✓		931	5931
BS 3100 WNB/400, BS 4200 DNB/400, BKS 400	400	30				✓	✓	✓		940	5940
BS 6000 DNB/500	400	30				✓	✓	✓		940	5940
BKH 450, BKS 450, BS 3100 WNB/400, BS 6000/500	450	30				✓	✓	✓		945	5945
BS 4200 DNB/400	450	30				✓	✓	✓		945	5945
BS 8000 D, BS 6000 DNB/500, BS 3100 WNB/400	500	30				✓	✓	✓		951	5951
BS 4200 DNB/400	500	30				✓	✓	✓		951	5951
<b>Cirkelzaagbladen voor handcirkelzagen</b>											
KGS 250, KGS 300, KGS 330, KGT 500	250	30	✓							94/93	5894
<b>ELU</b>											
<b>Handcirkelzagen</b>											
MH 151, MH 151/10	150	20	✓		✓		✓			35	5835
MH 55, MH 155, MH 65	170	30	✓	✓			✓			54	5854
MH 65	180	30			✓		✓			59	5859
MH 165, MH 265	190	30	✓		✓		✓			69	5869
MH 30, MH 82, MH 182, PS 174	210	30	✓		✓		✓			78	5878
<b>Bouw- en tafelcirkelzagen</b>											
KS 101, TGS 170, TGS 171, TGS 172, TGS 173, ETS 21	250	30	✓		✓		✓	✓		93	5893
ETS 23, ETS 31, ETS 33, KSU 101, RKS 1251, RKS 1253	250	30	✓		✓		✓	✓		93	5893
ETS 3001, ETS 3003	300	30	✓				✓	✓		930	5930
DG 102, SA 103, 104, MGS 105, LBK 500	400	30	✓				✓	✓		940	5940
RSA 133/25	500	30	✓				✓	✓		951	5951
<b>Cirkelzaagbladen voor handcirkelzagen</b>											
TGS 170, TGS 171, TGS 172, TGS 173, TGS 2271	250	30	✓							94/93	5894
TGS 273	250	30	✓							94/93	5894
<b>EMCO</b>											
<b>Bouw- en tafelcirkelzagen</b>											
Super Red-Ring 30 x 20	250	30	✓		✓		✓	✓		93	5893
<b>ERGO TOOLS PATTFIELD</b>											
<b>Handcirkelzagen</b>											
E-HKS 1600	190	20	✓							67	5867

# Cirkelzaagbladen volgens fabrikant/machinetype

Fabrikant/machinetype	Blad Ø mm	Gat Ø mm	Gebruik							kwb- code	Art.-nr.
			E	P	M	K	B	C	A		
<b>FEIN</b>											
<b>Handcirkelzagen</b>											
SSK 646	150	20	✓		✓		✓			35	5835
SSK 660	160	20	✓		✓		✓			45	5845
SSK 661, SSK 661-1	210	30	✓	✓	✓		✓			78	5878
<b>FELISATTI</b>											
<b>Cirkelzaagbladen voor handcirkelzagen</b>											
T 770, T 771, T 778, T 777, T 777 CE, T 84, T 85, T 87	250	20								96	5896
T 867 GS, T 777 B	250	20								96	5896
M 74, M 75, M 76, M 77, T 84, T 85, T 87, T 88	250	30	✓							94/93	5894
M 79, M 80, M 90, M 90E, T 82, T 92, T 97 CE, T 83	300	30	✓						✓	930	5930
T 91, T 91 CE	300	30	✓						✓	930	5930
<b>FESTO</b>											
<b>Handcirkelzagen</b>											
AU 35S2	125	20		✓						13	5813
AP 55, 55E, 55E-FS, 55EB, 55-FS, ATF 55, 55E, 55BE, 55-FS	160	20	✓		✓		✓			45	5845
AM 42S, 42A, AT 55E, 55EB, AU 42A, 42S, AUT 42S	170	30	✓				✓			54	5854
AXT 50LA, 55, AMT 42S	170	30	✓		✓		✓			54	5854
AU 55S, 60P, 60S, AUT 42S, 60S, AUP 605	180	30		✓	✓		✓			59	5859
AP 65E, 65E-FS, 65, 65EB, AP 65EB-FS, AT 65E-FS	190	30	✓		✓		✓			69	5969
AT 65E, 65EB, 65, 65EB-FS	190	30	✓		✓		✓			69	5969
AD 65, AP 65S, 68E, AU 65S, AXP 65, 200, AUP 65S	200	30	✓				✓			74	5874
Au 80S	230	30	✓				✓			85	5885
<b>Bouw- en tafelcirkelzagen</b>											
AD 85, AD 100, AD 100/1, AE 85	250	30	✓		✓	✓	✓	✓		93	5893
AXP 130, AXP 132E, BD 125	350	30	✓			✓	✓	✓		935	5935
BD 145, BD 145/1	400	30				✓	✓	✓		940	5940
BD 170	450	30				✓	✓	✓		945	5945
<b>FERM</b>											
<b>Handcirkelzagen</b>											
CSM 1002	165	20	✓							48	5848
CSM 1022	185	20	✓		✓		✓			57	5857
TSM 1008	200	16	✓		✓		✓			71	5871
MSM 1020, MSM 1007, MSM 1030 Red-Ring 30 x 16	210	30	✓	✓	✓		✓			78	5878
<b>Bouw- en tafelcirkelzagen</b>											
TSM 1011 Red-Ring 30 x 16	250	30	✓		✓	✓	✓	✓		93	5893
<b>Cirkelzaagbladen voor handcirkelzagen</b>											
MSM 1020 *1), MSM 1007 *1), MSM 1030 *1) *1) Red.-Ring 30 x 16	210	30	✓							78	5878
<b>FLOTT</b>											
<b>Bouw- en tafelcirkelzagen</b>											
Basic-Uni-Kombi 1011, Uni-Profi 2011, Profi 3011	250	30	✓		✓	✓	✓	✓		93	5893
Basic-Uni-Kombi, KS 2011D, KS 2011W, TKS 2011D	250	30	✓		✓	✓	✓	✓		93	5893
TKS 2011W	250	30	✓		✓	✓	✓	✓		93	5893
100000, 2000 Red-Ring 30 x 20	300	30	✓			✓	✓	✓		930	5930
Profi 2001 Red-Ring 30 x 20	315	30	✓			✓	✓	✓		931	5931

Fabrikant/machinetype	Blad Ømm	Gat Ømm	Gebruik							kwb-code	Art.-nr.
			E	P	M	K	B	C	A		
<b>HAFFNER</b>											
<b>Handcirkelzagen</b>											
KSU 105, KSU 125	125	20		✓						13	5813
KSU 50	160	20	✓		✓		✓			45	5845
KSU 110	170	30	✓				✓			54	5854
KSU 113, KSU 60	180	30		✓	✓		✓			59	5859
GL 136	200	16	✓		✓		✓			71	5871
AKS	200	30	✓				✓			74	5874
KS 75, KSU 118, RS 75	210	30	✓	✓	✓		✓			78	5878
HSU 85, KS 85, KSU 85	230	30	✓				✓			85	5885
SP 187, HUS 85	230	30	✓				✓			85	5885
<b>Bouw- en tafelcirkelzagen</b>											
AKS, GS 150, GS 165, GS 166, SP 189, 20, SP 195	250	30	✓		✓	✓	✓	✓		93	5893
SP 196, SP 197, SP 198, TGS 161, KL 140, TGS 162	250	30	✓		✓	✓	✓	✓		93	5893
TGS 163, TGS/GS 1+2	250	30	✓		✓	✓	✓	✓		93	5893
GS 155, GS 156, GS 157, GS 158, SP 221, SP 223	300	30	✓			✓	✓	✓		930	5930
SP 224, TGS 168, TGS 169, US 151, GS 148, GS 165	300	30	✓			✓	✓	✓		930	5930
GS 166, 950, TGS 200	300	30	✓			✓	✓	✓		930	5930
KS 120	315	30	✓			✓	✓	✓		931	5931
DGS 184, DGS 184 E, GS 183, GS 183M, KS 155	400	30				✓	✓	✓		940	5940
DGS 188, DGS 188 M, ZS 640, ZS 800, DGS 180, 182	400	30				✓	✓	✓		940	5940
185, GSA 184 (E), KS 155	400	30				✓	✓	✓		940	5940
DGS 124, DGS 187, GS 124, US 161, DGS 202, GS 161	500	30				✓	✓	✓		951	5951
GS 162	500	30				✓	✓	✓		951	5951
<b>Cirkelzaagbladen voor handcirkelzagen</b>											
GS 150	250	30	✓							94/93	5894
GS 146, GS 147, GFS 200, GS 157, GS 158	300	30	✓						✓	930	5930
GS 159, GS 160, ZS 800	350	30	✓							935	5935
<b>HANNING</b>											
<b>Handcirkelzagen</b>											
TK 20N, 20S, 200, 300	200	16	✓		✓		✓			71	5871
<b>Bouw- en tafelcirkelzagen</b>											
HKS 250 Red-Ring 30 x16	250	30	✓		✓	✓	✓	✓		93	5893
HTK 315/3SV	315	30	✓			✓	✓	✓		931	5931
<b>HITACHI</b>											
<b>Handcirkelzagen</b>											
C 5Y	125	20		✓						13	5813
C 5, CM 6, FC 5, 5SA, 5SA1	150	20	✓		✓		✓			35	5835
C 6DA, FC 6SA, 65A, C 6, D 1	160	20	✓		✓		✓			45	5845
C 6SA, PSU-6	170	30	✓				✓			54	5854
C 18DL, C 6MFA, C 6BU2, C 6BU2K	165	30	✓				✓			54	5854
C 8U	180	30		✓	✓		✓			59	5859
FC 7SA, PSM-7, 7A, PSU-7, C 7MFA, C 7BU2	190	30	✓		✓		✓			69	5969
C 8FA, C 8U, PSM-8, 8A, PSU-8	210	30	✓	✓	✓		✓			78	5878
C 9U, C 9U2 (235)	230	30	✓				✓			85	5885
<b>Bouw- en tafelcirkelzagen</b>											
PSU 13	315	30	✓			✓	✓	✓		931	5931
<b>Cirkelzaagbladen voor handcirkelzagen</b>											
C 10FSH (255)	255	30	✓							94/93	5894
C 12LSH (305)	305	30	✓						✓	930	5930

# Cirkelzaagbladen volgens fabrikant/machinetype

Fabrikant/machinetype	Blad Ø mm	Gat Ø mm	Gebruik							kwb- code	Art.-nr.
			E	P	M	K	B	C	A		
<b>HOLZ-HER</b>											
<b>Handcirkelzagen</b>											
264, 1420, 2103, 2104, 2105, 2106, HKU 50, 264, HKUS 50	160	20	✓		✓		✓			45	5845
281, 2115(T55a), 2266, 2271, 2281, HKUS 266, 281, 55 A	170	30	✓				✓			54	5854
2112, 2269, 2282, 2113, 2292, 2272, 2291, HKU 2272, 2291	180	30		✓	✓		✓			59	5859
HKUS 269, 272, 282, 55	180	30		✓	✓		✓			59	5859
211, 2114, 2116(T65a), 2117(T65), 2119(T65e), 2126, 2127	190	30	✓		✓		✓			69	5969
2269, 2282, 2292, 2116, 2117, 2119, HK 282	190	30	✓	✓	✓		✓			69	5969
2113, 2292, 2555, HK 201	200	30	✓				✓			74	5874
2264, 2267, 2279, 2284, PKS 267, 284	210	30	✓	✓	✓		✓			78	5878
2118(T85), 2120(T85e), 2279, 2293, 2294, 2118, 2120	230	30	✓				✓			85	5885
<b>Bouw- en tafelcirkelzagen</b>											
HKD 85, 275, PKS 1210, 1211, 1212, 1213, 1215, 1220	300	30	✓			✓	✓	✓		930	5930
PKS 275, HKD 275	300	30	✓			✓	✓	✓		930	5930
HKS 130, 150, 176, 276	350	30	✓			✓	✓	✓		935	5935
B 7K, HKS 155, 277	400	30				✓	✓	✓		940	5940
<b>INCA</b>											
<b>Bouw- en tafelcirkelzagen</b>											
MajOR Red-Ring 30 x 20	250	30	✓		✓		✓	✓		93	5893
<b>KRESS</b>											
<b>Handcirkelzagen</b>											
1050KS, 6050, 6055 Duo, CHKS 6055, 6050	160	20	✓		✓		✓			45	5845
6055a, Elekt.-Duo-Säge	160	20	✓	✓	✓		✓			45	5845
1400KS, 1600KS, 1500KS, 1600HTKS, 6060, 6060 B	190	20	✓		✓		✓			67	5867
CHKS 6060, 6006, 6066, 1800 KSE	190	20	✓		✓		✓			67	5867
<b>Cirkelzaagbladen voor handcirkelzagen</b>											
GST 90	250	30	✓							94/93	5894
<b>LESCHA</b>											
<b>Bouw- en tafelcirkelzagen</b>											
TKS 315 H, TKS 315 HS, TKS 315 N	315	30	✓			✓	✓	✓		931	5931
<b>LUTZ</b>											
<b>Bouw- en tafelcirkelzagen</b>											
Jumbo 2000, KKS 400, KKS Starr, RBK 500, Eurocut	315	30	✓			✓	✓	✓		931	5931
Jumbo	315	30	✓			✓	✓	✓		931	5931
LBK 500 Starr, LBK 500	400	30				✓	✓	✓		940	5940
RKS 700	450	30				✓	✓	✓		945	5945
LBK Starr, RKS 700	500	30				✓	✓	✓		951	5951
<b>LUX TOOLS</b>											
<b>Handcirkelzagen</b>											
Lux Tools	190	30	✓		✓		✓			69	5869
<b>MAFELL</b>											
<b>Handcirkelzagen</b>											
X 40, XE 40, SF 32	125	20		✓						13	5813
Biberella	150	13		✓						31	5831
MKS 55, MS 55, PS 52, A 55, X 55, XE 55, KSP 55(F)	160	20	✓		✓		✓			45	5845
KSS 330, FU 50	160	20	✓	✓	✓		✓			45	5845
A 55, B 55, FU 50, FU 550, FUS 50, FK 50	170	20		✓						51	5851

Fabrikant/machinetype	Blad Ø mm	Gat Ø mm	Gebruik							kwb- code	Art.-nr.
			E	P	M	K	B	C	A		
<b>MAFELL</b>											
<b>Handcirkelzagen</b>											
ERIKA 55	180	30		✓	✓		✓			59	5859
MKS 65, MS 65, ERIKA 60, KSP 65(F)	190	30	✓		✓		✓			69	5969
B 65, X 72	200	30	✓				✓			74	5874
MKS 75, MKS 85S, MS 75	210	30	✓	✓	✓		✓			78	5878
KSP 85 F	230	30	✓				✓			85	5885
<b>Bouw- en tafelvormzagen</b>											
A 85, FS 65, Fus 85, MKS 85, MS 85, ERIKA, MKS 85 N	250	30	✓		✓	✓	✓	✓		93	5893
MKS 85 S, ERIKA 85, FKS 65	250	30	✓		✓	✓	✓	✓		93	5893
FS 85, MKS 105, Biber, Biberex, MKS 105 E, MONIKA	315	30	✓			✓	✓	✓		931	5931
TFK 8G, TFK 8	315	30	✓			✓	✓	✓		931	5931
MKS 125, BSK 4, BSK 5, BSK 6, SF 32	350	30	✓			✓	✓	✓		935	5935
AZB, BK 3, FKB 150, TDH 4, TDH 425, TK 150, VKS 130	400	30				✓	✓	✓		940	5940
VKS 160, FS 130 S, TD 3, BSK 4, BSK 5, BSK 6	400	30				✓	✓	✓		940	5940
BK, BKV 4, FSG 165, TDH 450, TDH 5, BK 4, BSK 5	450	30				✓	✓	✓		945	5945
BSK 6, FSG 165K, MKS 185E, FSG 200K-240	450	30				✓	✓	✓		945	5945
BKV 5, FSG 2000, TDH 5/170, FSK 2000	500	30				✓	✓	✓		951	5951
<b>MAKITA</b>											
<b>Handcirkelzagen</b>											
5600NB, 5603R, 5600RDW, SR 1600	160	20	✓		✓		✓			45	5845
SR 1600	165	20	✓							48	5848
5600BR	170	20		✓						51	5851
5800, 5800B, 5800N, 5801B, S 800BR, SR 1800, 5500 S	180	20	✓		✓		✓			57	5857
3501, 5800BR	190	20	✓		✓		✓			67	5867
5703 R	190	30	✓		✓		✓			69	5869
5700	200	30	✓				✓			74	5874
5903 R	230	30	✓				✓			85	5885
<b>Bouw- en tafelvormzagen</b>											
2400 *1), SR 2402 *1), SR 2600 *1) *1) Red-Ring 30 x 25	250	30	✓		✓	✓	✓	✓		93	5893
5100 BR	315	30	✓			✓	✓	✓		931	5931
LS 1400 *1), 5143 R *1) Red-Ring 30 x 25	350	30	✓			✓	✓	✓		935	5935
<b>Cirkelzaagbladen voor handcirkelzagen</b>											
LS 1030 *1), LS 0813 *1) *1) Red-Ring 30 x 25	250	30	✓							94/93	5894
<b>METABO</b>											
<b>Handcirkelzagen</b>											
BHK 01, 2, KS 3340S, 3342, 4340, 6311, Max KS 40S	130	16			✓		✓			18	5818
KS 4342S	130	16			✓		✓			18	5818
BHK 2+3, 4340S	142	13		✓	✓		✓			29	5829
BTK 1, C 2, KS 1155S	165	20	✓							48	5848
6317S	180	20	✓		✓		✓			57	5857
BTK, KS 65S, KS 4345S, KS 4346S, KSE 1668S, Robert	190	20	✓		✓		✓			67	5867
TK 5348, KS 1266S, KS 1468S, 46 S, 5348, KS 166S	190	20	✓		✓		✓			67	5867
KS 1266, KS 4345S	190	20	✓		✓		✓			67	5867
KSE 1678S Signal, MAGNUM KGS E 1670S-SIGNAL	210	30	✓	✓	✓		✓			78	5878
<b>Bouw- en tafelvormzagen</b>											
Magnum TKU 1693, Magnum TK 1685, TKU 1633	250	30	✓		✓	✓	✓	✓		93	5893
TKU 1693, TK 1685	250	30	✓		✓	✓	✓	✓		93	5893
TK 1688(D)	300	30	✓			✓	✓	✓		930	5930
TK 168S, TK 1685D, TK 1685, TK 16850	315	30	✓			✓	✓	✓		931	5931



# Cirkelzaagbladen volgens fabrikant/machinetype

Fabrikant/machinetype	Blad Ømm	Gat Ømm	Gebruik							kwb- code	Art.-nr.
<b>METABO</b>			<b>E</b>	<b>P</b>	<b>M</b>	<b>K</b>	<b>B</b>	<b>C</b>	<b>A</b>		
<b>Cirkelzaagbladen voor handcirkelzagen</b>											
KGS E 1670 S, KGS E 16705 SIGNAL	210	30	✓		✓				✓	78	5878
KGS 16-300 (PLUS)	250	30	✓		✓				✓	94/93	5894
<b>MAC ALLISTER</b>			<b>E</b>	<b>P</b>	<b>M</b>	<b>K</b>	<b>B</b>	<b>C</b>	<b>A</b>		
<b>Handcirkelzagen</b>											
MCS 1200 L	165	16				✓				7	5807
MCS 1400 L	190	16	✓		✓		✓			65	5865
<b>Cirkelzaagbladen voor handcirkelzagen</b>											
MSMS255DBL	254	30	✓		✓					93	5893
<b>MILWAUKEE</b>			<b>E</b>	<b>P</b>	<b>M</b>	<b>K</b>	<b>B</b>	<b>C</b>	<b>A</b>		
<b>Cirkelzaagbladen voor handcirkelzagen</b>											
6494-50, 6496-50	250	30	✓							94/93	5894
<b>NIKO</b>			<b>E</b>	<b>P</b>	<b>M</b>	<b>K</b>	<b>B</b>	<b>C</b>	<b>A</b>		
<b>Bouw- en tafelcirkelzagen</b>											
TS 10 (254mm)	250	30	✓		✓	✓	✓	✓		93	5893
<b>Cirkelzaagbladen voor handcirkelzagen</b>											
MS 305 (254)	254	30	✓							94/93	5894
DC 14 (355x25,4)	355	25.4	✓							935	5935
<b>PARKSIDE</b>			<b>E</b>	<b>P</b>	<b>M</b>	<b>K</b>	<b>B</b>	<b>C</b>	<b>A</b>		
<b>Handcirkelzagen</b>											
PHKS 66	190	30	✓		✓		✓			69	5869
<b>PERLES</b>			<b>E</b>	<b>P</b>	<b>M</b>	<b>K</b>	<b>B</b>	<b>C</b>	<b>A</b>		
<b>Handcirkelzagen</b>											
KS 50	152	20	✓		✓		✓			35	5835
<b>PEUGEOT</b>			<b>E</b>	<b>P</b>	<b>M</b>	<b>K</b>	<b>B</b>	<b>C</b>	<b>A</b>		
<b>Handcirkelzagen</b>											
SC 46, 52, 52C, 53C	150	20	✓		✓		✓			35	5835
SC 4510XA	160	16	✓		✓		✓			43	5843
FIP 20S, FIP 50S	180	20	✓		✓		✓			57	5857
10XA, SC 65C, 650, 66C, SC 65010xA	184	16	✓		✓		✓			61	5861
<b>ROCKWELL</b>			<b>E</b>	<b>P</b>	<b>M</b>	<b>K</b>	<b>B</b>	<b>C</b>	<b>A</b>		
<b>Handcirkelzagen</b>											
63416	160	16	✓		✓		✓			43	5843
<b>RYOBI</b>			<b>E</b>	<b>P</b>	<b>M</b>	<b>K</b>	<b>B</b>	<b>C</b>	<b>A</b>		
<b>Handcirkelzagen</b>											
W-5502, W-560, W-560P	160	20	✓		✓		✓			45	5845
W-651, W-6502, W-66N, W-651A	180	20	✓		✓		✓			57	5857
W-6403NC, W-640NCI, W-6403C	184	16	✓		✓		✓			61	5861
W-750	200	16	✓		✓		✓			71	5871
<b>SCHEER</b>			<b>E</b>	<b>P</b>	<b>M</b>	<b>K</b>	<b>B</b>	<b>C</b>	<b>A</b>		
<b>Handcirkelzagen</b>											
MS 50	150	16	✓		✓		✓			33	5833
MS 45, MS 45E, MS 45/3, 45E	150	20	✓		✓		✓			35	5835
FM	160	16	✓		✓		✓			43	5843

Fabrikant/machinetype	Blad Ø mm	Gat Ø mm	Gebruik							kwb- code	Art.-nr.
<b>SCHEER</b>			<b>E</b>	<b>P</b>	<b>M</b>	<b>K</b>	<b>B</b>	<b>C</b>	<b>A</b>		
<b>Handcirkelzagen</b>											
MS 55	165	20	✓							48	5848
MS 65	190	30	✓		✓		✓			69	5969
MS 70, FM 16DNC, FM 16 Elektronic, FM 16 Standard	200	30	✓				✓			74	5874
MS 85	230	30	✓				✓			85	5885
<b>SCHEPPACH</b>			<b>E</b>	<b>P</b>	<b>M</b>	<b>K</b>	<b>B</b>	<b>C</b>	<b>A</b>		
<b>Bouw- en tafelcirkelzagen</b>											
TKG 250, TKS 250, KSE 250	250	30	✓		✓	✓	✓	✓		93	5893
TK 1685 Magnum, TKH, TKU, TS 4000, TS 4010	300	30	✓			✓	✓	✓		930	5930
TK, TKH, TKU, ts 4000, ts 4010, FORSATO XL, TG 315	315	30	✓			✓	✓	✓		931	5931
FORSATO XXL	315	30	✓			✓	✓	✓		931	5931
BSH 400, BSH 500	400	30				✓	✓	✓		940	5940
BS 500, BSH 500, WS 500	450	30				✓	✓	✓		945	5945
BS 500, BSH 500, WS 500	500	30				✓	✓	✓		951	5951
KE 6, KE 6M, KE 60, KE 60M, KE 6011, KE 611, KH 6	600	30				✓		✓		960	5960
KH 60, KW 60, KW 60M, KW 601, KW 6011, KW 611	600	30				✓		✓		960	5960
KDZ 700, KE 70, KW 70, KWZ 700, KH 70, KW 7, KWZ 7	700	30				✓		✓		970	5970
KD 2700, KE 7011, KEZ 700, KW 2700	700	30				✓		✓		970	5970
<b>SCHLEICHER</b>			<b>E</b>	<b>P</b>	<b>M</b>	<b>K</b>	<b>B</b>	<b>C</b>	<b>A</b>		
<b>Bouw- en tafelcirkelzagen</b>											
310, 330	300	30	✓			✓	✓	✓		930	5930
<b>Cirkelzaagbladen voor handcirkelzagen</b>											
6	300	30	✓						✓	930	5930
07, 08	350	30	✓							935	5935
<b>SKIL</b>			<b>E</b>	<b>P</b>	<b>M</b>	<b>K</b>	<b>B</b>	<b>C</b>	<b>A</b>		
<b>Handcirkelzagen</b>											
5240H, 5140	130	16			✓		✓			18	5818
533, 553	150	13		✓						31	5831
1850H, 1850	150	20	✓		✓		✓			35	5835
367, 416H, 534, 536, 552B, 552H, 856, 1408H, 1409H	160	16	✓		✓		✓			43	5843
1410H, 1855U, 1854, 1855H, 1865	160	16	✓		✓		✓			43	5843
22501B	170	30	✓	✓			✓			54	5854
1865, 537, 553B, 553H, 559, 559U, 574U, 77, 77U, 857	184	16	✓		✓		✓			61	5861
1850, 1865, 599U	184	16	✓		✓		✓			61	5861
1865H, 1965U, 1865U, 5565, 5666, 5566, 5266, 554B	190	16	✓		✓		✓			65	5865
554H, 8244, 825, 858	190	16	✓		✓		✓			65	5865
1965U	190	30	✓		✓		✓			69	5869
1524H, 1873H	210	30	✓	✓			✓			78	5878
1525H, 1886H, 1986, 1985U	230	30	✓				✓			85	5885
<b>Bouw- en tafelcirkelzagen</b>											
107 *1), 860 *1), 1526H, 1899H, *1) Red-Ring 30 x 16	250	30	✓		✓	✓	✓	✓		93	5893
127, 2127	300	30	✓			✓	✓	✓		930	5930
<b>STAYER</b>			<b>E</b>	<b>P</b>	<b>M</b>	<b>K</b>	<b>B</b>	<b>C</b>	<b>A</b>		
<b>Handcirkelzagen</b>											
CP 66, CP 66E	190	30	✓		✓		✓			69	5869
CP 76	210	30	✓	✓			✓			78	5878
CP 86	230	30	✓				✓			85	5885

# Cirkelzaagbladen volgens fabrikant/machinetype

Fabrikant/machinetype	Blad Ømm	Gat Ømm	Gebruik							kwb- code	Art.-nr.
			E	P	M	K	B	C	A		
<b>STAYER</b>											
<b>Cirkelzaagbladen voor handcirkelzagen</b>											
SLL 250, SCE 1600, SC 270, SC 271, SLL 251	250	30	✓							94/93	5894
SLL 251 E, SL 251 E, SL 250 E	250	30	✓							94/93	5894
<b>STRIEBIG</b>											
<b>Bouw- en tafelcirkelzagen</b>											
Plattensäge	300	30	✓			✓	✓	✓		930	5930
<b>TOOLTEC</b>											
<b>Handcirkelzagen</b>											
TOOLTEC Handkreissäge	185	20	✓		✓		✓			57	5857
<b>Bouw- en tafelcirkelzagen</b>											
TOOLTEC Bau- und Tisch-Kreissäge	200	30	✓				✓			74	5874
<b>ULMIA</b>											
<b>Handcirkelzagen</b>											
1610, 1607	160	16	✓		✓		✓			43	5843
1607, 1708	200	16	✓	✓	✓		✓			71	5871
1706	200	30	✓				✓			74	5874
<b>Bouw- en tafelcirkelzagen</b>											
1622, 1625, 1710, 1610, 1710R, 1710SN, 1711, KS 1	250	30	✓		✓	✓	✓	✓		93	5893
1711, 1712, 1725	300	30	✓			✓	✓	✓		930	5930
KS 300	315	30	✓			✓	✓	✓		931	5931
1712, 1725, 1728, 1729, 1711, 1712RT, 1712/1712R	350	30	✓			✓	✓	✓		935	5935
<b>Cirkelzaagbladen voor handcirkelzagen</b>											
1728	350	30	✓							935	5935
<b>WEGOMA</b>											
<b>Bouw- en tafelcirkelzagen</b>											
TS 400	400	30				✓	✓	✓		940	5940
SD 25, SD 30	500	30				✓	✓	✓		951	5951
<b>Cirkelzaagbladen voor handcirkelzagen</b>											
RS 460	250	30	✓							94/93	5894
RS 660	300	30	✓						✓	930	5930
SD 16, S 40, S 4W, SD 17AE, SD 17 M+P	350	30	✓							935	5935
<b>WOLF</b>											
<b>Handcirkelzagen</b>											
6070	184	16	✓		✓		✓			61	5861
<b>WORX DIY</b>											
<b>Handcirkelzagen</b>											
WX425	160	25			✓		✓			46	5846
WX431K	185	30		✓	✓		✓			59	5859
WX441, WX445, 1500W Blade Runner	190	30	✓		✓		✓			69	5869
<b>WORX PRO</b>											
<b>Handcirkelzagen</b>											
WU530	165	30	✓							48	5848
WT431KE	185	30		✓	✓		✓			59	5859
WU 430.1, WU434/WU434.1	190	30	✓		✓		✓			69	5869

### EASY CUT universeel blad



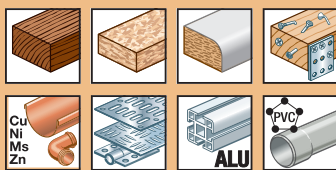











- Met hardmetaal versterkt
- Speciale wisselrand
- Tandstand nul
- Geschikt voor alle zagen
- Precieze en zuivere snede



- Spaanplaat
- Spaanplaat met coating
- Bouwhout
- Non-ferrometaal
- Plaatstaal
- Aluminium profielen
- Kunststof incl. plexiglas"

E

### Cirkelzaagbladen voor handcirkelzagen Ø 150 tot Ø 230 mm

Fabrikant	kwb Code	Art.-nr.	Ø x  mm	Tand	 mm	 mm			EAN	Kwaliteit
Bosch Scheer	<b>E 33</b>	583333	150 x 16	24	2,8	1,8		1	4 009315 833330	★★★★★
AEG B & D ELU Fein Hitachi Metabo Perles Peugeot Scheer Skil	<b>E 35</b>	583533	150 x 20	24	2,8	1,8		1	4 009315 835334	★★★★★
B & D	<b>E 41</b>	584133	156 x 12,75	24	2,8	1,8		1	4 009315 841335	★★★★★
B & D Bosch Peugeot Rockwell Scheer Skil Ulmia	<b>E 43</b>	584333	160 x 16	24	2,8	1,8		1	4 009315 843339	★★★★★
AEG Bosch Einhell Fein Festo Haffner Hitachi Holz-Her Kress Mafell Makita Ryobi	<b>E 45</b>	584533	160 x 20	24	2,8	1,8		1	4 009315 845333	★★★★★
Einhell Ferm Makita Metabo Scheer Worx Diy Worx Pro	<b>E 48</b>	584833	165 x 20	24	2,8	1,8		1	4 009315 848334	★★★★★
Bosch ELU Festo Haffner Hitachi Holz-Her Skil	<b>E 54</b>	585433	170 x 30	24	2,8	1,8		1	4 009315 854335	★★★★★
B & D Ergo Tools Pattfield Ferm Makita, Metabo Peugeot Ryobi Skil Tooltec	<b>E 57</b>	585733	180 x 20	30	2,8	1,8		1	4 009315 857336	★★★★★
B & D DeWalt Peugeot Ryobi Skil Wolf	<b>E 61</b>	586133	184 x 16	30	2,8	1,8		1	4 009315 861333	★★★★★

## EASY CUT universeel blad

- Met hardmetaal versterkt
- Speciale wisseltand
- Tandstand nul
- Geschikt voor alle zagen
- Precieze en zuivere snede

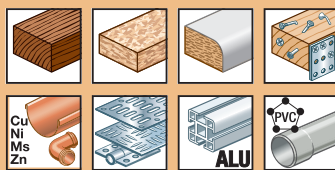

- Spaanplaat
- Spaanplaat met coating
- Bouwhout
- Non-ferrometaal
- Plaatstaal
- Aluminium profielen
- Kunststof incl. plexiglas"

# E

## Cirkelzaagbladen voor handcirkelzagen Ø 150 tot Ø 230 mm

Fabrikant	kwb Code	Art.-nr.	Ø x  mm	Tand	 mm	 mm			EAN	Kwaliteit
Bosch Mac Allister Skil	<b>E 65</b>	586533	190 x 16	30	2,8	1,8		1		★★★★★
Einhell Kress Makita Metabo	<b>E 67</b>	586733	190 x 20	30	2,8	1,8		1		★★★★★
AEG Bosch DeWalt Einhell ELU Festo Hitachi Holz-Her Lux Tools Mafell Makita Parkside Scheer Skil Stayer Worx Diy, Worx Pro	<b>E 69</b>	586933	190 x 30	30	2,8	1,8		1		★★★★★
B & D Einhell Ferm Haffner Hanning Ryobi Ulmia	<b>E 71</b>	587133	200 x 16	30	2,8	1,8		1		★★★★★
AEG Bosch Festo Haffner Holz-Her Mafell, Makita Scheer Tooltec Ulmia	<b>E 74</b>	587433	200 x 30	30	2,8	1,8		1		★★★★★
AEG Alpha Tools B & D, Bosch Einhell Elektra-Beckum ELU Fein, Ferm Haffner Hitachi Holz-Her Mafell, Metabo Skil, Stayer	<b>E 78</b>	587833	210 x 30	34	2,8	1,8		1		★★★★★
AEG B & D, Bosch Festo Haffner Hitachi Holz-Her Mafell Makita Scheer Skil Stayer	<b>E 85</b>	588533	230 x 30	34	2,8	1,8		1		★★★★★

### Precisieblad



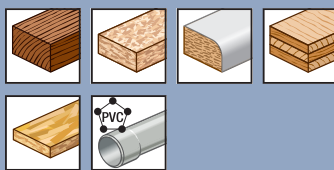

- Met hardmetaal versterkt
- Fijn getand
- Tandstand positief
- Voor hand-, bouw- en tafelickeelzagen
- Snelle en fijne snede
- Zuivere snijranden



- Massief hout
- Spaanplaat met coating (werk- en keukenwerkbladen)
- Meubel-, spaan- en hardvezelplaten
- Glasvezelversterkte kunststof

**P**

### Cirkelzaagbladen voor handcirkelzagen Ø 125 tot Ø 230 mm

Fabrikant	kwb Code	Art.-nr.	Ø x  mm	Tand	 mm	 mm			EAN	Kwaliteit
AEG Festo Haffner Hitachi Mafell	<b>P 13</b>	581366	125 x 20	36	2,5	1,5		1	4 009315 813660	★★★★★
B & D	<b>P 23</b>	582366	140 x 12,75	42	2,5	1,5		1	4 009315 823669	★★★★★
Metabo	<b>P 29</b>	582966	142 x 13	42	2,5	1,5		1	4 009315 829661	★★★★★
Kress Mafell Skil	<b>P 31</b>	583166	150 x 13	48	2,8	1,8		1	4 009315 831664	★★★★★
AEG B & D ELU Fein Hitachi Metabo Perles, Peugeot Scheer, Skil	<b>P 35</b>	583566	150 x 20	48	2,8	1,8		1	4 009315 835662	★★★★★
Mafell Makita	<b>P 51</b>	585166	170 x 20	52	2,8	1,8		1	4 009315 851662	★★★★★
Bosch ELU Fern, Festo Haffner Hitachi Holz-Her Mafell Worx Diy, Worx Pro	<b>P 59</b>	585966	180 x 30	56	2,8	1,8		1	4 009315 859668	★★★★★
AEG Bosch Festo Haffner Holz-Her Mafell, Makita Scheer Tooltec Ulmia	<b>P 74</b>	587466	200 x 30	64	2,8	1,8		1	4 009315 874661	★★★★★
AEG Alpha Tools B & D, Bosch Einhell Elektra-Beckum ELU Fern, Fein Haffner Hitachi Holz-Her Mafell, Metabo Skil, Stayer	<b>P 78</b>	587866	210 x 30	64	2,8	1,8		1	4 009315 878669	★★★★★
AEG B & D, Bosch Festo Haffner Hitachi Holz-Her Mafell, Makita Scheer Skil Stayer	<b>P 85</b>	588566	230 x 30	64	3,2	2,2		1	4 009315 885667	★★★★★

## Zaagblad voor spaanplaat

- Met hardmetaal versterkt
- Normaal getand
- Tandstand positief
- Voor handcirkelzagen
- Snelle en zuivere snede

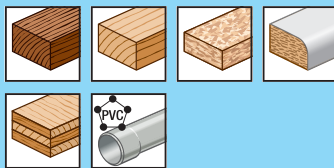

- Massief hout
- Spaanplaat met coating (werk- en keukenwerkbladen)
- Meubel-, spaan- en hardvezelplaten
- Glasvezelversterkte kunststof

# M

## Cirkelzaagbladen voor handcirkelzagen Ø 127 tot Ø 230 mm

Fabrikant	kwb Code	Art.-nr.	Ø x  mm	Tand	 mm	 mm			EAN	Kwaliteit
B & D	<b>M 15</b>	581555	127 x 12,75	18	2,4	1,4		1	4 009315 815558	★★★★★
Bosch Metabo Skil	<b>M 18</b>	581855	130 x 16	18	2,4	1,4		1	4 009315 818559	★★★★★
B & D	<b>M 23</b>	582355	140 x 12,75	18	2,4	1,4		1	4 009315 823553	★★★★★
AEG Bosch Holz-Her Metabo Peugeot Stayer	<b>M 28</b>	582855	140 x 20	18	2,4	1,4		1	4 009315 828558	★★★★★
Metabo	<b>M 29</b>	582955	142 x 13	18	2,4	1,4		1	4 009315 829555	★★★★★
Bosch Scheer	<b>M 33</b>	583355	150 x 16	20	2,4	1,4		1	4 009315 833552	★★★★★
AEG B & D ELU Fein Hitachi Metabo Perles Peugeot Scheer, Skil	<b>M 35</b>	583555	150 x 20	20	2,4	1,4		1	4 009315 835556	★★★★★
B & D Bosch Peugeot Rockwell Scheer, Skil Ulmia	<b>M 43</b>	584355	160 x 16	20	2,4	1,4		1	4 009315 843551	★★★★★
AEG Bosch Einhell Fein Festo Haffner Hitachi Holz-Her Kress Mafell, Makita Ryobi	<b>M 45</b>	584555	160 x 20	20	2,4	1,4		1	4 009315 845555	★★★★★
Fabrikate alte DDR	<b>M 46</b>	584655	160 x 25	20	2,4	1,4		1	4 009315 846552	★★★★★
B & D Ferm Makita Metabo Peugeot Ryobi Skil Tooltec	<b>M57</b>	585755	180 x 20	22	2,4	1,4		1	4 009315 857558	★★★★★
Bosch ELU Festo Haffner Hitachi Holz-Her Mafell Worx Diy, Worx Pro	<b>M 59</b>	585955	180 x 30	22	2,4	1,4		1	4 009315 859552	★★★★★

### Zaagblad voor spaanplaat



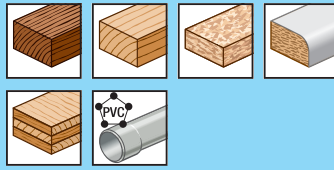



- Met hardmetaal versterkt
- Normaal getand
- Tandstand positief
- Voor handcirkelzagen
- Snelle en zuivere snede



- Massief hout
- Spaanplaat met coating (werk- en keukenwerkbladen)
- Meubel-, spaan- en hardvezelplaten
- Glasvezelversterkte kunststof

M

### Cirkelzaagbladen voor handcirkelzagen Ø 125 tot Ø 230 mm

Fabrikant	kwb Code	Art.-nr.	Ø x mm	Tand	mm	mm			EAN	Kwaliteit
B & D DeWalt Peugeot Ryobi Skil Wolf	<b>M 61</b>	586155	184 x 16	22	2,4	1,4		1	4 009315 861555	★★★★★
Bosch Mac Allister Skil	<b>M 65</b>	586555	190 x 16	30	2,4	1,4		1	4 009315 865553	★★★★★
Einhell Kress Makita Metabo	<b>M 67</b>	586755	190 x 20	30	2,4	1,4		1	4 009315 867557	★★★★★
AEG B & D Bosch DeWalt Einhell ELU Festo Hitachi Holz-Her Lux Tools Mafell Makita Parkside Scheer Skil Stayer Worx Diy Worx Pro	<b>M 69</b>	586955	190 x 30	30	2,4	1,4		1	4 009315 869551	★★★★★
B & D Einhell Ferm Haffner Hanning Ryobi Ulmia	<b>M 71</b>	587155	200 x 16	30	2,4	1,6		1	4 009315 871554	★★★★★
Fabrikate alte DDR	<b>M 73</b>	587355	200 x 25	30	2,6	1,6		1	4 009315 873558	★★★★★
AEG Alpha Tools B & D Bosch Einhell Elektra-Beckum ELU Fein Ferm Haffner Hitachi Holz-Her Mafell Metabo Skil Stayer	<b>M 78</b>	587855	210 x 30	30	2,4	1,6		1	4 009315 878553	★★★★★



## Zaagblad voor profielhout



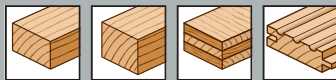













- Chroom-vanadium
- Spits getand
- Tandstand positief
- Voor hand-, bouw- en tafelcirkelzagen
- Fijne en precieze snede



- Zachthout
- Multiplex
- Panelen
- Profielschroten

# B

## Cirkelzaagbladen voor handcirkelzagen Ø 127 tot Ø 230 mm

Fabrikant	kwb Code	Art.-nr.	Ø x  mm	Tand	 mm	 mm			EAN	Kwaliteit
B & D	<b>B 15</b>	581511	127 x 12,75	80	2,2	1,2		1	4 009315 815114	★★★★★
Bosch Metabo Skil	<b>B 18</b>	581811	130 x 16	64	2,2	1,2		1	4 009315 818115	★★★★★
B & D	<b>B 23</b>	582311	140 x 12,75	80	2,2	1,2		1	4 009315 823119	★★★★★
AEG Bosch Holz-Her Metabo Peugeot Stayer	<b>B 28</b>	582811	140 x 20	90	2,2	1,2		1	4 009315 828114	★★★★★
Metabo	<b>B 29</b>	582911	142 x 13	80	2,2	1,2		1	4 009315 829111	★★★★★
Bosch Scheer	<b>B 33</b>	583311	150 x 16	64	2,2	1,2		1	4 009315 833118	★★★★★
AEG B & D ELU Fein Hitachi Metabo Perles Peugeot Scheer Skil	<b>B 35</b>	583511	150 x 20	90	2,2	1,2		1	4 009315 835112	★★★★★
B & D	<b>B 41</b>	584111	156 x 12,75	80	2,2	1,2		1	4 009315 841113	★★★★★
B & D Bosch Peugeot Rockwell Scheer Skil Ulmia	<b>B 43</b>	584311	160 x 16	110	2,2	1,2		1	4 009315 843117	★★★★★
AEG Bosch Einhell Fein Festo Haffner Hitachi Holz-Her Kress Mafell Makita Ryobi	<b>B 45</b>	584511	160 x 20	110	2,2	1,2		1	4 009315 845111	★★★★★
Fabrikate alte DDR	<b>B 46</b>	584611	160 x 25	110	2,2	1,2		1	4 009315 846118	★★★★★
Bosch ELU Festo Haffner Hitachi Holz-Her Skil	<b>B 54</b>	585411	170 x 30	56	2,4	1,4		1	4 009315 841113	★★★★★

## Zaagblad voor profielhout



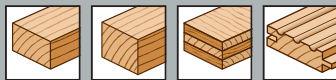









- Chroom-vanadium
- Spits getand
- Tandstand positief
- Voor hand-, bouw- en tafelfirkelzagen
- Fijne en precieze snede



- Zachthout
- Multiplex
- Panelen
- Profielschroten

**B**

## Cirkelzaagbladen voor handcirkelzagen Ø 127 tot Ø 230 mm

Fabrikant	kwb Code	Art.-nr.	Ø x  mm	Tand	 mm	 mm			EAN	Kwaliteit
B & D Ferm Makita Metabo Peugeot Ryobi Tooltec	<b>B 57</b>	585711	180 x 20	72	2,4	1,4		1	4 009315 857114	★★★★★
Bosch ELU Festo Haffner Holz-Her Hitachi Mafell Worx Diy Worx Pro	<b>B 59</b>	585911	180 x 30	72	2,4	1,4		1	4 009315 859118	★★★★★
B & D DeWalt Einhell Peugeot Ryobi Skil Wolf	<b>B 61</b>	586111	184 x 16	100	2,4	1,4		1	4 009315 861111	★★★★★
Bosch Mac Allister Skil	<b>B 65</b>	586511	190 x 16	110	2,4	1,4		1	4 009315 865119	★★★★★
Einhell Kress Makita Metabo	<b>B 67</b>	586711	190 x 20	110	2,4	1,4		1	4 009315 867113	★★★★★
AEG B & D Bosch DeWalt Einhell ELU Festo Hitachi Holz-Her Lux Tools Mafell Makita Parkside Scheer Skil Stayer Worx Diy Worx Pro	<b>B 69</b>	586911	190 x 30	72	2,4	1,4		1	4 009315 869117	★★★★★
B & D Einhell Ferm Haffner Hanning Ryobi Ulmia	<b>B 71</b>	587111	200 x 16	72	2,6	1,6		1	4 009315 871110	★★★★★
Fabrikate alte DDR	<b>B 73</b>	587311	200 x 25	72	2,6	1,6		1	4 009315 873114	★★★★★

# Cirkelzaagbladen voor handcirkelzagen

## Zaagblad voor profielhout



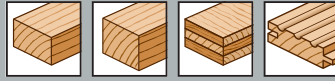

- Chroom-vanadium
- Spits getand
- Tandstand positief
- Voor hand-, bouw- en tafelcirkelzagen
- Fijne en precieze snede



- Zachthout
- Multiplex
- Panelen
- Profielschroten

**B**

## Cirkelzaagbladen voor handcirkelzagen Ø 127 tot Ø 230 mm

Fabrikant	kwb Code	Art.-nr.	Ø x mm	Tand	mm	mm			EAN	Kwaliteit
AEG Bosch Festo Haffner Holz-Her Mafell Makita Scheer Tooltec Ulmia	<b>B 74</b>	<b>587411</b>	200 x 30	72	2,6	1,6		1	4 009315 874111	★★★★★
AEG Alpha Tools B & D Bosch Einhell Elektra-Beckum ELU Fein Ferm Haffner Hitachi Holz-Her Mafell Metabo Skil Stayer	<b>B 78</b>	<b>587811</b>	210 x 30	72	2,6	1,6		1	4 009315 878119	★★★★★
AEG B & D Bosch Festo Haffner Hitachi Holz-Her Mafell Makita Scheer Skil Stayer	<b>B 85</b>	<b>588511</b>	230 x 30	72	2,6	1,6		1	4 009315 885117	★★★★★

### EASY CUT universeel blad

- Met hardmetaal versterkt
- Speciale wisseltand
- Tandstand nul
- Geschikt voor alle zagen
- Precieze en zuivere snede"

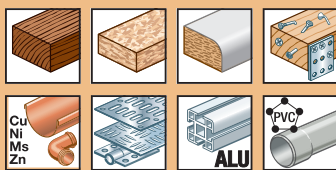

- Spaanplaat
- Spaanplaat met coating
- Bouwhout
- Non-ferrometaal
- Plaatstaal
- Aluminium profielen
- Kunststof incl. plexiglas"

**E**

### Cirkelzaagbladen voor bouw- en tafelvormzagen Ø 250 tot Ø 350 mm

Fabrikant	kwb Code	Art.-nr.	Ø x mm	Tand	mm	mm			EAN	Kwaliteit
AEG B & D Einhell DeWalt Elektra-Beckum ELU Emco Ferm Festo Flott Haffner Hanning Inca Mafell Makita Metabo Niko Scheppach Skil Ulmia	<b>E 93</b>	<b>589333</b>	250 x 30	42	3	2		1	4 009315 893334	★★★★★
DeWalt ELU Flott Haffner Holz-Her Metabo Scheppach Schleicher Skil Striebig Ulmia	<b>E 930</b>	<b>593033</b>	300 x 30	48	3,2	2,2		1	4 009315 930336	★★★★★
AL-KO Atika Einhell Elektra-Beckum Flott Haffner Hanning Hitachi Lescha Lutz Mafell Makita Metabo Scheppach Ulmia	<b>E 931</b>	<b>593133</b>	315 x 30	48	3,2	2,2		1	4 009315 931333	★★★★★
DeWalt Festo Holz-Her Mafell Makita Ulmia	<b>E 935</b>	<b>593533</b>	350 x 30	54	3,2	2,2		1	4 009315 935331	★★★★★

# Cirkelzaagbladen voor bouw- en tafelcirkelzagen

## Zaagblad voor spaanplaat



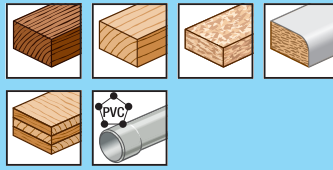



- Met hardmetaal versterkt
- Normaal getand
- Tandstand positief
- Voor handcirkelzagen
- Snelle en zuivere snede"



- Massief hout
- Spaanplaat met coating (werk- en keukenwerkbladen)
- Meubel-, spaan- en hardvezelplaten
- Glasvezelversterkte kunststof

M

## Cirkelzaagbladen voor bouw- en tafelcirkelzagen Ø 250 mm

Fabrikant	kwb Code	Art.-nr.	Ø x  mm	Tand	 mm	 mm			EAN	Kwaliteit
AEG DeWalt Elektra-Beckum ELU Emco Festo Flott Haffner Hanning Inca Mafell Makita Scheppach Skil Ulmia	<b>M 93</b>	589355	250 x 30	42	2,2	2,2		1	 4 009315 893556	★★★★★

## Zaagblad voor bouwhout

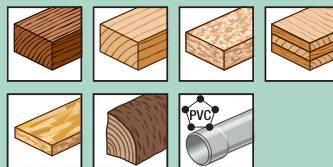

- Met hardmetaal versterkt
- Grof getand
- Tandstand nul
- Voor bouw- en tafelcirkelzagen
- Snelle en grove snede



- Massief hout
- Meubel-, spaan- en hardvezelplaten
- Glasvezelversterkte kunststof"

K

## Cirkelzaagbladen voor bouw- en tafelcirkelzagen Ø 250 tot Ø 500 mm

Fabrikant	kwb Code	Art.-nr.	Ø x  mm	Tand	 mm	 mm			EAN	Kwaliteit
AEG DeWalt Einhell Elektra-Beckum ELU Emco Ferm Festo Flott Haffner Hanning Inca Mafell Makita Metabo Niko Scheppach Skil Ulmia	<b>K 93</b>	589344	250 x 30	24	2,8	1,8		1	 4 009315 893440	★★★★★

## Zaagblad voor bouwhout



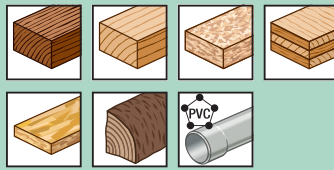







- Met hardmetaal versterkt
- Grof getand
- Tandstand nul
- Voor bouw- en tafelfirkelzagen
- Snelle en grove snede



- Massief hout
- Meubel-, spaan- en hardvezelplaten
- Glasvezelversterkte kunststof<sup>1</sup>

**K**

## Cirkelzaagbladen voor bouw- en tafelfirkelzagen Ø 250 tot Ø 500 mm

Fabrikant	kwb Code	Art.-nr.	Ø x  mm	Tand	 mm	 mm			EAN	Kwaliteit
DeWalt Flott Haffner Holz-Her Metabo Scheppach Schleicher Skil Striebig Ulmia	<b>K 930</b>	593044	300 x 30	28	2,8	1,8		1	4 009315 930442	★★★★★
AL-KO Atika Einhell Elektra-Beckum Flott Haffner Hanning Hitachi Lescha Lutz Mafell Makita Metabo Scheppach Ulmia	<b>K 931</b>	593144	315 x 30	28	2,8	1,8		1	4 009315 931449	★★★★★
DeWalt Festo Holz-Her Mafell Makita Ulmia	<b>K 935</b>	593544	350 x 30	32	3	2		1	4 009315 935447	★★★★★
Atika DeWalt Elektra-Beckum ELU Festo Haffner Holz-Her Lutz Mafell Scheppach Wegoma	<b>K 940</b>	594044	400 x 30	36	3,2	2,2		1	4 009315 940441	★★★★★
AL-KO Atika Elektra-Beckum Festo Lutz Mafell Scheppach	<b>K 945</b>	594544	450 x 30	40	3,5	2,5		1	4 009315 945446	★★★★★
AL-KO Atika DeWalt Elektra-Beckum ELU Haffner Lutz Mafell Scheppach Wegoma	<b>K 951</b>	595144	500 x 30	44	3,5	2,5		1	4 009315 951447	★★★★★

## Zaagblad voor profielhout



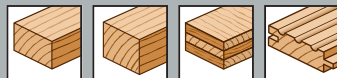











- Chroom-vanadium
- Spits getand
- Tandstand positief
- Voor hand-, bouw- en tafelcirkelzagen
- Fijne en precieze snede



- Zachthout
- Multiplex
- Panelen
- Profielschroten

# B

## Cirkelzaagbladen voor bouw- en tafelcirkelzagen Ø 250 tot Ø 500 mm

Fabrikant	kwb Code	Art.-nr.	Ø x  mm	Tand	 mm	 mm			EAN	Kwaliteit
AEG B & D Bosch DeWalt Einhell Elektra-Beckum ELU Emco Festo Flott Haffner Hanning Inca Mafell Makita Metabo Niko Scheppach Skil Ulmia	<b>B 93</b>	<b>589311</b>	250 x 30	80	2,4	1,4		1	 4 009315 893112	★★★★★
DeWalt ELU Flott Haffner Holz-Her Metabo Scheppach Schleicher Skil Striebig Ulmia	<b>B 930</b>	<b>593011</b>	300 x 30	80	2,6	1,6		1	 4 009315 930114	★★★★★
AL-KO Atika Einhell Elektra-Beckum Flott Haffner Hanning Hitachi Lescha Lutz Mafell, Makita Metabo Scheppach Ulmia	<b>B 931</b>	<b>593111</b>	315 x 30	80	2,8	1,8		1	 4 009315 931111	★★★★★
DeWalt Festo Holz-Her Mafell, Makita Ulmia	<b>B 935</b>	<b>593511</b>	350 x 30	80	2,8	1,8		1	 4 009315 935119	★★★★★
Atika DeWalt Elektra-Beckum ELU Festo Haffner Holz-Her Lutz Mafell Scheppach Wegoma	<b>B 940</b>	<b>594011</b>	400 x 30	80	3	2		1	 4 009315 940113	★★★★★

## Zaagblad voor profielhout



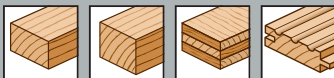





- Chroom-vanadium
- Spits getand
- Tandstand positief
- Voor hand-, bouw- en tafelcirkelzagen
- Fijne en precieze snede



- Zachthout
- Multiplex
- Panelen
- Profielschroten

**B**

## Cirkelzaagbladen voor bouw- en tafelcirkelzagen Ø 250 tot Ø 500 mm

Fabrikant	kwb Code	Art.-nr.	Ø x  mm	Tand	 mm	 mm			EAN	Kwaliteit
AL-KO Atika Elektra-Beckum Festo Lutz Mafell Scheppach	<b>B 945</b>	594511	450 x 30	80	3,2	2,2		1	 4 009315 11945118	★★★★★
AL-KO Atika DeWalt Elektra-Beckum ELU Haffner Lutz Mafell Scheppach Wegoma	<b>B 951</b>	595111	500 x 30	80	3,5	2,5		1	 4 009315 11935119	★★★★★



## Zaagblad voor brandhout



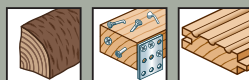







- Chroom-vanadium
- Grof getand
- Tandstand positief
- Voor bouw- en tafelcirkelzagen
- Snelle en grove snede



- Brandhout
- Bouwhout
- Profielschroten

# C

## Cirkelzaagbladen voor bouw- en tafelcirkelzagen Ø 250 tot Ø 500 mm

Fabrikant	kwb Code	Art.-nr.	Ø x  mm	Tand	 mm	 mm			EAN	Kwaliteit
AEG Bosch DeWalt Einhell Elektra-Beckum ELU Emco Ferm Festo Flott Haffner Hanning Inca Mafell, Makita Metabo Niko Scheppach Skil Ulmia	<b>C 93</b>	589322	250 x 30	56	2,4	1,4		1	4 009315 893228	★★★★★
DeWalt ELU Flott Haffner Holz-Her Metabo Scheppach Schleicher Skil Striebig Ulmia	<b>C 930</b>	593022	300 x 30	56	2,6	1,6		1	4 009315 930220	★★★★★
AL-KO Atika Einhell Elektra-Beckum Flott Haffner Hanning Hitachi Lescha Lutz Mafell Makita Metabo Scheppach Ulmia	<b>C 931</b>	593122	315 x 30	56	2,8	1,8		1	4 009315 931227	★★★★★
DeWalt Festo Holz-Her Mafell Makita Ulmia	<b>C 935</b>	593522	350 x 30	56	2,8	1,8		1	4 009315 935225	★★★★★
Atika DeWalt Elektra-Beckum ELU Festo Haffner Holz-Her Lutz Mafell Scheppach Wegoma	<b>C 940</b>	594022	400 x 30	56	3	2		1	4 009315 940229	★★★★★

## Zaagblad voor brandhout



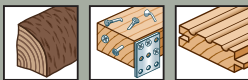





- Chroom-vanadium
- Grof getand
- Tandstand positief
- Voor bouw- en tafelcirkelzagen
- Snelle en grove snede



- Brandhout
- Bouwhout
- Profielschroten

**C**

## Cirkelzaagbladen voor bouw- en tafelcirkelzagen Ø 250 tot Ø 500 mm

Fabrikant	kwb Code	Art.-nr.	Ø x  mm	Tand	 mm	 mm			EAN	Kwaliteit
AL-KO Atika Elektra-Beckum Festo Lutz Mafell Scheppach	<b>C 945</b>	<b>594522</b>	450 x 30	56	3,2	2,2		1	 4 009315 945224	★★★★★
AL-KO Atika DeWalt Elektra-Beckum ELU Haffner Lutz Mafell Scheppach Wegoma	<b>C 951</b>	<b>595122</b>	500 x 30	56	3,5	2,5		1	 4 009315 951225	★★★★★

# Cirkelzaagbladen voor kap- en verstekzagen

## EASY CUT universeel blad



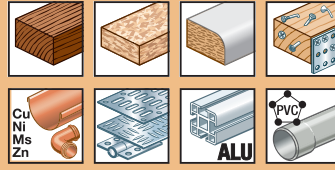









- Met hardmetaal versterkt
- Speciale wisseltand
- Tandstand nul
- Geschikt voor alle zagen
- Precieze en zuivere snede"



- Spaanplaat
- Spaanplaat met coating
- Bouwhout
- Non-ferrometaal
- Plaatstaal
- Aluminium profielen
- Kunststof incl. plexiglas"

**E**

## Cirkelzaagbladen voor kap- en verstekzagen, negatieve tandvorm Ø 205 tot Ø 350 mm

Fabrikant	kwb Code	Art.-nr.	Ø x  mm	Tand	 mm	 mm			EAN	Kwaliteit
AEG B & D Bosch Elektra-Beckum ELU Fein Ferm Haffner Hitachi Holz-Her Mafell Metabo Skil Stayer	<b>E 78</b>	587833	210 x 30	34	2,8	1,8		1	 4 009315 878331	★★★★★
AEG DeWalt Einhell Elektra-Beckum ELU Emco Felisatti Festo Flott Haffner Hanning Hitachi Inca Kress Mac Allister Mafell, Makita Metabo Milwaukee Niko Scheppach Skil Stayer Ulmia Wegoma	<b>E 93</b>	589333	250 x 30	42	3	2		1	 4 009315 893334	★★★★★
DeWalt Felisatti Flott Haffner Hitachi Holz-Her Schleicher Skil Striebig Ulmia Wegoma	<b>E 930</b>	593033	300 x 30	48	3,2	2,2		1	 4 009315 930336	★★★★★
AL-KO Atika Elektra-Beckum Flott Haffner Hanning Hitachi Lescha Lutz Mafell Makita Metabo Scheppach	<b>E 931</b>	593133	315 x 30	48	3,2	2,2		1	 4 009315 931333	★★★★★

### EASY CUT universeel blad

- Met hardmetaal versterkt
- Speciale wisseltand
- Tandstand nul
- Geschikt voor alle zagen
- Precieze en zuivere snede"

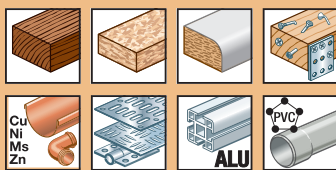

- Spaanplaat
- Spaanplaat met coating
- Bouwhout
- Non-ferrometaal
- Plaatstaal
- Aluminium profielen
- Kunststof incl. plexiglas"

**E**

### Cirkelzaagbladen voor kap- en verstekzagen, negatieve tandvorm Ø 205 tot Ø 350 mm

Fabrikant	kwb Code	Art.-nr.	Ø x  mm	Tand	mm	mm			EAN	Kwaliteit
DeWalt Festo Haffner Holz-Her Mafell Makita Niko Schleicher Ulmia Wegoma	<b>E 935</b>	<b>593533</b>	350 x 30	54	3,2	2,2		1	4 009315 935331	★★★★★

### Zaagblad voor profielhout

- Chroom-vanadium
- Fijn getand
- **negatieve tandvorm**
- voor kap- en verstekzagen
- Fijne en precieze snede

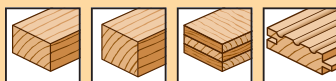

- Zachthout
- Multiplex
- Panelen
- Profielschroten

**A**

### Cirkelzaagbladen voor kap- en verstekzagen, negatieve tandvorm Ø 210 tot Ø 300 mm

Fabrikant	kwb Code	Art.-nr.	Ø x  mm	Tand	mm	mm			EAN	Kwaliteit
Bosch DeWalt Felisatti Flott Haffner Hitachi Holz-Her Schleicher Skil Striebig Ulmia Wegoma	<b>A 930</b>	<b>593000</b>	300 x 30	96	2,6	1,6		1	4 009315 930008	★★★★★

## Verlooppingen voor cirkelzaagbladen



Verlooppingen voor alle gangbare cirkelzaagbladen met gaten van Ø 20 mm naar Ø 16 mm en gaten van Ø 30 mm naar Ø 16 mm, Ø 20 mm en Ø 25 mm.

Art.-nr.	Ø buiten	Ø binnen	+	+	+	EAN
582016	20	16	1,2	+	2	4 009315 820163
583016	30	16	1,2	+	2	4 009315 830162
583020	30	20	1,2	+	2	4 009315 830209
583025	30	25	1,2	+	2	4 009315 830254



## kwb-info

### Een kwestie van veiligheid



Zeker als men met handcirkelzagen, bouw- en tafelcirkelzagen of kap- en verstekzagen werkt, vliegen de stukken er letterlijk af. Daarom moet het oog als belangrijkste zintuig bij al deze zaagwerkzaamheden worden beschermd. Dus heeft kwb een hoogwaardig, ook voor bril dragers geschikt assortiment veiligheidsbrillen samengesteld.

Natuurlijk zijn deze veiligheidsbrillen ook geschikt voor andere toepassingen zoals boren, frezen, schuren en lassen, en dat zowel binnen als buiten.

Alle informatie hierover vindt u in onze kwb-folder voor arbeidsveiligheid of op het internet op [www.kwb.eu](http://www.kwb.eu)



... altijd de passende toebehoren voor uw machine!



# ZAAGKETTINGEN

## Zaagkettingen



### De voordelen van de zaagkettingen

- **Zaagkettingen voor elektrische en motorzagen**  
Zaagkettingen voor professioneel gebruik in bosbouw en hobby. Blijven lang scherp, met een langdurig hoog zaagvermogen, ook in harde houtsoorten. Markeringen op de tanden geven de juiste slijphoek aan, wat het slijpen vergemakkelijkt.

### Voor elke kettingzaag altijd de juiste zaagketting

Zwaard- lengte	Aandrijfschakeldikten	Steek
30 cm	1,1 MM, 1,3 MM	3/8"
35 cm	1,1 MM, 1,3 MM	3/8"
38 cm	1,1 MM, 1,3 MM, 1,5 MM	3/8", .325
40 cm	1,1 MM, 1,3 MM, 1,5 MM, 1,6 MM	3/8", .325

### Waar moet bij een zaagketting op worden gelet?

Bij de aankoop van een zaagketting zijn de steek en het aantal aandrijfschakels (= lengte) belangrijk. Bovendien wordt de keuze van de juiste ketting bepaald door de toepassing resp. de benodigde zaagbreedte van de aandrijfschakels.



z.B. 3/8"

#### Steek:

Om de steek te bepalen, wordt de afstand van het midden van een klinkbout tot het midden van de tweede daaropvolgende klinkbout gemeten en door twee gedeeld. Het resultaat is de steek in millimeter, die volgens het internationale gebruik naar inch wordt omgerekend.



z.B. 44

#### Aandrijfschakel:

Met een aandrijfschakel bedoelt men het deel van de ketting dat in de groef van het zwaard 'loopt'. De lengte van de zaagketting wordt bepaald door het totale aantal aandrijfschakels.

z.B. 1,3 MM



#### Aandrijfschakeldikte:

De aandrijfschakeldikte geeft de breedte aan van het deel van de aandrijfschakel dat in de groef van de geleider loopt. Bij 3/8"-zaagkettingen is 1,3 mm en soms ook 1,1 mm mogelijk. Bij .325"- en 3/8"-zaagkettingen zijn 1,3 mm, 1,5 mm en 1,6 mm (zeer zware kettingzagen) mogelijk.



## Zaagkettingen voor kettingzagen



Art.-nr.	kwb-code	Zwaard-lengte	Steek	Aandrijf-schakels	Aandrijf-schakel-dikte			EAN
<b>HOBBY</b>								
640344	A-44	30	3/8"	44	1,3		1	4 009316 403440
640345	A-45	30	3/8"	45	1,3		1	4 009316 403457
640346	A-46	30	3/8"	46	1,3		1	4 009316 403464
640349	A-49	35	3/8"	49	1,3		1	4 009316 403495
640350	A-50	35	3/8"	50	1,3		1	4 009316 403501
640352	A-52	35	3/8"	52	1,3		1	4 009316 403525
640355	A-55	40	3/8"	55	1,3		1	4 009316 403556
640356	A-56	40	3/8"	56	1,3		1	4 009316 403563
640357	A-57	40	3/8"	57	1,3		1	4 009316 403570
640644	C-44	30	3/8"	44	1,1		1	4 009316 406441
640650	C-50	35	3/8"	50	1,1		1	4 009316 406502
640652	C-52	35	3/8"	52	1,1		1	4 009316 406526

Art.-nr.	kwb-code	Zwaard-lengte	Steek	Aandrijf-schakels	Aandrijf-schakel-dikte			EAN
<b>PROFESSIONEEL</b>								
640864	D-64	38	.325	64	1,3		1	4 009316 408643
641262	G-62	38	.325	62	1,6		1	4 009316 412626
641756	L-56	38	3/8"	56	1,5		1	4 009316 417560
641856	M-56	33	3/8"	56	1,6		1	4 009316 418567
641860	M-60	40	3/8"	60	1,6		1	4 009316 418604

De zaagkettingen voor kettingzagen zijn optimaal bruikbaar voor houtwinning, boomverzorging, bouwplaatsen, timmermanswerkzaamheden en beeldhouwen.

Voor een langere levensduur van de rail in het zwaard, moet de zaagketting regelmatig worden geolied.

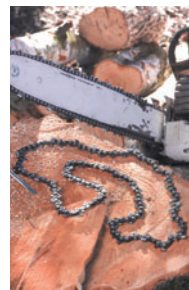

### kwb-info



## Een kwestie van veiligheid

Bij alle werkzaamheden met een zaagketting dient als veiligheidssuitrusting een veiligheidshelm met vizier en gehoorbescherming te worden gedragen.





### kwb-info





## Het juiste onderhoud





Om de levensduur van de geleider in het zaagkettingzwaard te verlengen, moet de zaagketting regelmatig worden geolied. kwb biedt de passende zaagkettingolie.











Art.-nr. 939110





Fabrikant/machinetype	Zwaardlengte cm	Steek 	Aandrijf- schakels 	Aandrijf- schakeldikte 		kwb- code	Art.-nr.
<b>ALKO</b>							
KB350, KB450, 3500, 4000, 4500, KB3501, 4001, 5001							
E 25A, E 1200 S, E 125, E 1400, E 1500, EK 25 A, KB 3500, KB 4000, KB 4001, KB 4500, KB 4501, KE 14, KE 16, KE 18, KSB 1450, P11, P12, 2000, 2300, 3000, KS, KSB, Elektro							
<b>ALPINA-CASTOR</b>							
EL140, EL160, EL170, 300, 330, 380, 423, 432, 438, CP34S, P34, P34S, P350, P380, P438, PR350, PR370, Euro35, Euro40, Euro45, KS300, KS350, CX35, CX40, CX 45, Energie 1.6, E1.8, Jolly40 Garden Ranger							
<b>BLACK &amp; DECKER</b>							
CS30, CS35, D35KS, D40KS, DN301, DN302, DN400, DN401, DN402, DN402/B, DN404, DN404/B, DN404-TypH2, DN410, DN412, DN416, DN 430, GK30, GK40, GK100/110, GK120, GK130, GK300, GK31, GK310, GK320, GK321, GK322, GK330, GK331, GK3300, GK35, GK42, GK43, GK430, GK425, GK435, GK440, GK535, GK540, 5400, 8308, 8310, 8312, 8314, GK1300K, GK1330, GK1440, GK1530, GK1630T, GK1430, GK1435, GK1630 XC, GK1635, GK1830, Pro40							
GK1430, GK1300							
<b>BEL PICKPINE</b>							
16							
<b>BLITZ</b>							
B 300, B 304, B 34, E 140F							
<b>BOSCH</b>							
EKS 1535, 1540, KS 300							
<b>BULLKRAFT</b>							
KSE 30, KS 300, KSE 1300B, GK 30, KSM 25, 300 S							
<b>CASTEL GARDEN</b>							
XC 35P							
<b>DYNAMAC</b>							
30F, E 140F							
<b>EFCO</b>							
114E, 134, 135, 116							
<b>FARM U. GARTEN</b>	30	3/8"	44	1,3	ø 4,0	A44	640344
P349, PR350							
<b>FOLUX</b>							
F 30F							
<b>GRIZZLY</b>							
BKS 35-12							
<b>HANDY</b>							
30HF, E 140F							
<b>IKRA</b>							
MKS 30							
<b>MCCULLOCH</b>							
Electramac 16-EE, ES 30, 22, 24, 26, 35, 36, 40, PM-394, PM-494, M 1, 2, 2B, 4, 4B, 6, 6B, Californian, Arizona, Eager-Beaver, 10, 12, 12 A/S, 14 AVS, 16 E, 170, 374, 384, 394, 484, 494, 735, 930, 935, C 180, EM-8							
Mac110, 120, 130, 140, 160, PM300, PM310, PM320, PM330, PM340, PM360, PM364, PM370, PM380, PM394, PM470, PM474, PM480, PM484, PM494, PM530, PM538, PM540, 832, 833, 835, 836, 838, 839, 930, Euromac S32, S33, S34, S36, S40, S41, ELECTR							
<b>METABO</b>							
5338 B							
<b>OLEO MAC OLYM.</b>							
35, 233, 234, 240, 241, 244, 335, 340, 930, 935D, 935X, 935DX, E140F, E160F, E170F, E1700, E170, E1900, E-200							
936, 940C, E140							
<b>PARTNER</b>							
1400E, 1500-EL, 1601, 1602, 1612, 1613, 1614, 1616, 1618							
<b>RYOBI</b>							
35B, CS 36C, CS 41, CSE 330, CSE 3330, CSE 385CB, HC 31, HCS 31, HC 36, HC 41, CS 1530, CS 1535, CS 1540							
CS 290, C 300, CS1530							
<b>STARK-SYMPRA-SYMPRATEC</b>							
1400, 1412, 1430, 14830							





Fabrikant/machinetype	Zwaardlengte cm	Steek 	Aandrijf- schakels 	Aandrijf- schakeldikte 		kwb- code	Art.-nr.
<b>STEINMAX</b>	<b>30</b>	3/8"	44	1,3	ø 4,0	A44	<b>640344</b>
CS 300							
<b>STIGA</b>							
SP 340							
<b>STIHL</b>							
009, 010, 011, 012, 015, 018C, 019, 020, 020/T, 021, 023, 023C, 023L, 025, 025C, E 10, E 14, E 20, E 140, E 160, E 180, E 180C, E 220, E 220C, MS 180C, MS 190, MS 190T, MS 200, MS 200T, MS 210, MS 211, MS 230, MS 250, MSE 160, MSE 180, MSE 200, AVH-Elektronic							
<b>TECHNIC TOOL</b>							
PP 1250							
<b>AEG</b>							
KS 30							
<b>ALKO</b>							
Hobby 320, E135, E1200E, 1400E, 1500E							
E 25A, E 1200 S, E 125, E 1400, E 1500, EK 25 A, KB 3500, KB 4000, KB 4001, KB 4500, KB 4501, KE 14, KE 16, KE 18, KSB 1450, P11, P12, 2000, 2300, 3000, KS, KSB, Elektro							
<b>ALPINA-CASTOR</b>							
A10, A10E, A12, A12E, A14, A14E, E100, E120, E130, E150, E160, E170, KS1400B, KS1500B, P360, P390							
<b>BLACK &amp; DECKER</b>							
CS30, CS35, D35KS, D40KS, DN301, DN302, DN400, DN401, DN402, DN402/B, DN404, DN404/B, DN404-TypH2, DN410, DN412, DN416, DN 430, GK30, GK40, GK100/110, GK120, GK130, GK300, GK31, GK310, GK320, GK321, GK322, GK330, GK331, GK3300, GK35, GK42, GK43, GK430, GK425, GK435, GK440, GK535, GK540, 5400, 8308, 8310, 8312, 8314, GK1300K, GK1330, GK1440, GK1530, GK1630T, GK1430, GK1435, GK1630 XC, GK1635, GK1830, Pro40							
L10							
<b>BOSCH</b>							
AES 35, AKE 30B, AKE 30E, AKE 30-19Pro, AKE 30-16S, AKE 35B, AKE 40B, AKE 300B, PKE 10B, PKE 25, PKE 30 PowerSharp, PKE 30B, PKE 35B, PKE 40B, PKE 40BC, PKE 1350B, GKE 35BC, 1586							
<b>BUDGET</b>							
BKS 301							
<b>DOLMAR</b>							
101, 200, 201, 260, 290							
101 PowerSharp							
<b>ECHO</b>							
CS 200E, CS 280E, CS 280EVL, CS 290EVL, CS 300, CS 302, CS 320, CS 3000, CS 3050							
<b>EFCO</b>							
131							
136, 140							
<b>EINHELL</b>							
CS 280, EKS 35, EKS 35-1, MKS 30, MKS 34, PE 34/2, PE 35/3ZS, PES 2000, PES 30/2, PES 30-2, PES 34/3, PES 34/2, PES 34/3, PES 35, PES 35/2TS, PES 35-2, PES 35-3, PES 40S, PKS 35-1AV, PES 40/3, PES 1435, PES 1540, PES 1640, PES 1540, PES 1640, PES 1840, KSE 1435, KSE 1635, KSE 1640, KSE 2000, KSE 3000, KSE 4000							
<b>FRONTIER</b>							
MK 1=Quadra							
<b>HITACHI</b>							
CS 280A, CS 280B							
<b>HOMELITE</b>							
i335, i3350B, D 3850B, D 3850BC, 23AV, Sabre S 3350B, S 1035							
<b>HUSQUARNA</b>							
Husky 33, Husky 34							

Fabrikant/machinetype	Zwaardlengte cm	Steek 	Aandrijf- schakels 	Aandrijf- schakeldikte 		kwb- code	Art.-nr.
<b>IKRA</b>							
KS30ST, KS400, KS12A, A104P PowerSharp, A104A							
A104P+S, A204S, A205B, FA12, FA14, KS12, H014S, KS14, KS30ST, KS400, KS1200B, KS1250B, KS1300, Shark1300, KS1400, KS1400A, KS1400B, KS1500, KS1600, KS2000, 1200KS, Shark PE1400, Sup-Pro 1500, KS1500T, KS 1500TS, KS1700DL, KSE2000, EKS30, EKS35, EKS40, EKS1500-35, EKS1400, EKS1600, EKS1650, EKS1700, EKS1800, EKS2000, BKS301, BKS402, BKS4135, PKS40							
<b>JONSERED</b>							
2033, 370, 380, CS2115EL, CS2120EL, CS2137							
<b>KOMATSU ZENOAH</b>							
G31AVS, G310TS, G3100, G3200, G3300, G380AVS, G3800, G2800AVS							
SDK 100							
Electric 5011B, Electric 5012B, Electric, 5014-NB, Electric 5016-B, Electric 5016-NB							
<b>MCCULLOCH</b>							
Electramac 230/1030, 230, 312, 312s, 330, 1030, ES22, S12, Mac 930/12, Euromac 30/E30/ES30, Euromac S12, PM 360/364/730/930							
<b>OLEO MAC OLYM.</b>							
931, 932, 932C							
<b>OPEM</b>							
130Z							
<b>PARTNER</b>							
1400E, 1500-EL, 1601, 1602, 1612, 1613, 1614, 1616, 1618							
330, 335, 340, 345, 350, 351, 357, 360, 365, 370, 371, 385, 389, 390, 405, P-420, P 740, P 842, P842CC	30	3/8"	45	1,3	ø 4,0	A45	640345
341, 395, 420, 1200, 1450							
<b>PEUGEOT</b>							
TLS 1630, TRC 1630, TLS 1635, TLS 1635A, TRC 1635, TLS 1640, TRC 1640, EKS1740							
<b>POULAN</b>							
Micro 25, Micro 25A							
<b>REMINGTON</b>							
860 AV, Cutter, EL6 DELUXE							
<b>SHINDAIWA-SDK-ISEKI</b>							
140, 160, 285s, 300s, 305s, 305AVZ, 340, 345, 346, 350, 352s, 355, 357, 357s, 360, 377, 391, 395, A-090, 102, 103, 104, 105, 107, 110, 110P, 113L+P, 117P, 100, E 150, 315, YB 301, YB 401, A 090B, A 100C, A 102, A 150B							
<b>SKIL</b>							
1600HE, 1601HE, 1602HE, 1603H, 1604H, 1606H, 1610U, 1612U, 1616U, 1620U, 1634U, 1636U, 1712U							
<b>SOLO</b>							
613, 614, 620, 630, 633, 635, 635ECO, 636, 637, 640, 643							
<b>STIGA</b>							
930							
<b>TALON</b>							
AC2101, AC2105, AC2109, AC2111, AC3100							
<b>TAS-TANAKA</b>							
290, 300, ECS 320, ECS 330, ECS 3301, ECS 3351, ECS 3401, TCS 3301S, TCS 3401							
<b>DOLMAR</b>							
33, 40, 100, 100s, 102, 103, 104, 105, 108, 270, 271, 275, 285, 290, 295, ES 3, ES 6A, ES 30, ES 32A, ES 33A, ES 35, ES 37A, ES 38A, ES 40A (ab 09/01), ES 41A, ES 42A, ES 140, ES 151A, ES 152A, ES 153A, ES 160, ES 160A, ES 161A, ES 162A, ES 163A, ES 171A, ES 172A, ES 173A, ES 183A, ES 1600, ES 2030A, ES 2035A, ES 2040A, ES 2135A, ES 2140A, PS 33, PS 34, PS 36, PS 41, PS 45 (1,3mm), PS 39, PS 330, PS 340, PS 341, PS 342, PS 344, PS 350, PS 390, PS 400, PS 401, PS 3300TH, PS 3410, PS 3500TH, PS 3400TH, PS 3410TH	30	3/8"	46	1,3	ø 4,0	A46	640346





Fabrikant/machinetype	Zwaardlengte cm	Steek 	Aandrijf- schakels 	Aandrijf- schakeldikte 		kwb- code	Art.-nr.
<b>MAKITA</b> DCS 33, DCS 34, DCS 300, DCS 330, DCS 330S, DCS 330TH, DCS 340, DCS 341, DCS 342, DCS 344, DCS 350, DCS 380, DCS 390, DCS 400, DCS 401, DCS 3300TH, DCS 3400TH, DCS 3401TH, DCS 3500, DCS 3501, DCS 4610, DES 350, DES 400, UC 300, UC 3000, UC 3000A, UC 3001A, UC 3003A, UC 3500, UC 3500A, UC 3501A, UC 3503A, UC 4000, UC 4000A, UC 4001A, UC 4003A, 5014B, 5016B, 5016NB	<b>30</b>	3/8"	46	1,3	ø 4,0	A46	<b>640346</b>
<b>ZENOAH</b> G 300T, G 300AVS							
<b>ALKO</b> KB350, KB450, 3500, 4000, 4500, KB3501, 4001, 5001							
<b>ALPINA-CASTOR</b> EL140, EL160, EL170, 300, 330, 380, 423, 432, 438, CP34S, P34, P34S, P350, P380, P438, PR350, PR370, Euro35, Euro40, Euro45, KS300, KS350, CX35, CX40, CX 45, Energie 1.6, E1.8, Jolly40 Garden Ranger							
<b>BLACK &amp; DECKER</b> CS30, CS35, D35KS, D40KS, DN301, DN302, DN400, DN401, DN402, DN402/B, DN404, DN404/B, DN404-TypH2, DN410, DN412, DN416, DN 430, GK30, GK40, GK100/110, GK120, GK130, GK300, GK31, GK310, GK320, GK321, GK322, GK330, GK331, GK3300, GK35, GK42, GK43, GK430, GK425, GK435, GK440, GK535, GK540, 5400, 8308, 8310, 8312, 8314, GK1300K, GK1330, GK1440, GK1530, GK1630T, GK1430, GK1435, GK1630 XC, GK1635, GK1830, Pro40 GK1635TX, GK1635TG, GK1435 L10							
<b>BEL PICKPINE</b> 34, 16							
<b>BLITZ</b> B 35D, B 38							
<b>BONUS</b> KSB 35							
<b>BULLKRAFT</b> KSE 1300B, BES 1300B, KS 350, KS 350/2							
<b>DYNAMAC</b> 35F							
<b>EFCO</b> 114E, 134, 135, 116	<b>35</b>	3/8"	49	1,3	ø 4,0	A49	<b>640349</b>
<b>EINHELL</b> AC 31114, BKS 38/35, MKS 35, PBK 35/35							
<b>FLEURELLE</b> KSB 1735							
<b>FOLUX</b> F 35, F 35F							
<b>GRIZZLY</b> Farmer MKS 350, BKS 35-14, BKS 38-14, BKS 38-16, EKS 1600, EKS 1800, EKS 400I, EKS 400TL, EKS 2000, P390, BKS 350, BKS 400, KSI 2000							
<b>HANDY</b> 35 HF							
<b>HURRICANE</b> MKS 38/35							
<b>HUSQUARNA</b> CMI 1735BKS, BKS 35-14, KS 1938/35							
<b>MCCULLOCH</b> E14, Electramac14E, ES80, 230, 1030, S22, ES30, Euromac35, 833, S12, S33, S34, Mac12, 130, 140, 833, 835, 836, Mini Mac30, Mini Mac833, PM730, Titan7 Electramac 16-EE, ES 30, 22, 24, 26, 35, 36, 40, PM-394, PM-494, M 1, 2, 2B, 4, 4B, 6, 6B, Californian, Arizona, Eager-Beaver, 10, 12, 12 A/S, 14 AVS, 16 E, 170, 374, 384, 394, 484, 494, 735, 930, 935, C 180, EM-8 Mac110, 120, 130, 140, 160, PM300, PM310, PM320, PM330, PM340, PM360, PM364, PM370, PM380, PM394, PM470, PM474, PM480, PM484, PM494, PM530, PM538, PM540, 832, 833, 835, 836, 838, 839, 930, Euromac S32, S33, S34, S36, S40, S41, ELECTR							





Fabrikant/machinetype	Zwaardlengte cm	Steek 	Aandrijf- schakels 	Aandrijf- schakeldikte 		kwb- code	Art.-nr.
<b>OLEO MAC OLYM.</b> 35, 233, 234, 240, 241, 244, 335, 340, 930, 935D, 935X, 935DX, E140F, E160F, E170F, E1700, E170, E1900, E-200 936, 940C, E140	35	3/8"	49	1,3	ø 4,0	A49	640349
<b>REMINGTON</b> Mighty Mite 500/812/814							
<b>RYOBI</b> 35B, CS 36C, CS 41, CSE 330, CSE 3330, CSE 385CB, HC 31, HCS 31, HC 36, HC 41, CS 1530, CS 1535, CS 1540 CSE 385CB, HC 36, CS 360, CS1535							
<b>SHARK</b> BKS3540							
<b>STARK-SYMPRA-SYMPRATEC</b> 1414, 1435, 14350, 14835							
<b>STEINMAX</b> CS 360							
<b>TALON</b> AC2101, AC2105, AC2109, AC2111, AC3100							
<b>UNIROPA</b> BKS3840							
<b>ALKO</b> E 25A, E 1200 S, E 125, E 1400, E 1500, EK 25 A, KB 3500, KB 4000, KB 4001, KB 4500, KB 4501, KE 14, KE 16, KE 18, KSB 1450, P11, P12, 2000, 2300, 3000, KS, KSB, Elektro							
<b>ALPINA-CASTOR</b> A10, A10E, A12, A12E, A14, A14E, E100, E120, E130, E150, E160, E170, KS1400B, KS1500B, P360, P390 EL140, EL160, EL170, 300, 330, 380, 423, 432, 438, CP34S, P34, P34S, P350, P380, P438, PR350, PR370, Euro35, Euro40, Euro45, KS300, KS350, CX35, CX40, CX 45, Energie 1.6, E1.8, Jolly40 Garden Ranger							
<b>BULLKRAFT</b> KS 350, KS 350/2, KS 400, KS 400/2							
<b>CASTEL GARDEN</b> XC 18EL, XC 20EL, XC 35P, XC 36, XC 37							
<b>DOLMAR</b> 101, 200, 201, 260, 290							
<b>EFCO</b> 117E, 119E							
<b>EINHELL</b> MKS 35, PES 1435							
<b>EUROMAC</b> S 14/35/ES 35/ES 24/530, PM 370/374/470/474/735, Titan 35, E35							
<b>FARM U. GARTEN</b> P349, PR350 160EL, 165EL, 170EL, 180EL, 360P, 370P, 390P							
<b>GRIZZLY</b> BKS 35-32, BKS 35-38, PKS 360/390, EKS 2500QT							
<b>IKRA</b> MKS 35, KS1300Shark							
<b>MCCULLOCH</b> Electramac235, 1035, 35, Euromac530, S14, Mac Cut, Mac 538, 538a, 538e, 540, 545, 545e, 546, California, California 2000/Kit, 930,935, PM36, 370, 374, 470, 474, 486, 735, Titan35, PM 1-10, 2-10, 3-10, 4-10, 5-10, 6-10, 7-10, 10-10, 55, PM60, 70, 80, 81, 555, PM570, 610, 650, 655, PM700, 800, 805, 850, PM1000, DE-50, SP-60, Titan 50, 57 Electramac 16-EE, ES 30, 22, 24, 26, 35, 36, 40, PM-394, PM-494, M 1, 2, 2B, 4, 4B, 6, 6B, Californian, Arizona, Eager-Beaver, 10, 12, 12 A/S, 14 AVS, 16 E, 170, 374, 384, 394, 484, 494, 735, 930, 935, C 180, EM-8							





Fabrikant/machinetype	Zwaardlengte cm	Steek 	Aandrijf- schakels 	Aandrijf- schakeldikte 		kwb- code	Art.-nr.
<b>MCCULLOCH</b>	35	3/8"	50	1,3	ø 4,0	A50	640350
PM 1-10, 2-10, 3-10, 4-10, 5-10, 6-10, 7-10, 10-10, 55, PM60, 70, 80, 81, 555, PM570, 610, 650, 655, PM700, 800, 805, 850, PM1000, DE-50, SP-60, Titan 50, 57							
<b>OLEO MAC OLYM.</b>							
35, 233, 234, 240, 241, 244, 335, 340, 930, 935D, 935X, 935DX, E140F, E160F, E170F, E1700, E170, E1900, E-200							
<b>PARTNER</b>							
1400E, 1500-EL, 1601, 1602, 1612, 1613, 1614, 1616, 1618							
330, 335, 340, 345, 350, 351, 357, 360, 365, 370, 371, 385, 389, 390, 405, P-420, P 740, P 842, P842CC							
341, 395, 420, 1614							
P1535, P1550, 1640, P1850, P538, 538E							
<b>PEUGEOT</b>							
TLS 1630, TRC 1630, TLS 1635, TLS 1635A, TRC 1635, TLS 1640, TRC 1640, EKS1740							
<b>REMINGTON</b>							
Electricpower, Limb`n`-Trim, 1450							
<b>SHARK</b>							
1300-35							
<b>SOLO</b>							
634, E-105, KSB 2035							
<b>STIGA</b>							
935, SP 340, SE 1.6							
SE 1.8, SE180, SE 190, SE 200Q, SP 370, SP 410, SPR 350							
<b>STIHL</b>							
009, 010, 011, 012, 015, 018C, 019, 020, 020/T, 021, 023, 023C, 023L, 025, 025C, E 10, E 14, E 20, E 140, E 160, E 180, E 180C, E 220, E 220C, MS 180C, MS 190, MS 190T, MS 200, MS 200T, MS 210, MS 211, MS 230, MS 250, MSE 160, MSE 180, MSE 200, AVH-Elektronik							
<b>AEG</b>	35	3/8"	52	1,3	ø 4,0	A52	640352
KSE 35, KS 35							
<b>ALKO</b>							
BKS 35/35 II, KE 2000/35, KE40-16/11, KE1400/35, KE1600/35							
E 25A, E 1200 S, E 125, E 1400, E 1500, EK 25 A, KB 3500, KB 4000, KB 4001, KB 4500, KB 4501, KE 14, KE 16, KE 18, KSB 1450, P11, P12, 2000, 2300, 3000, KS, KSB, Elektro							
<b>ALPINA-CASTOR</b>							
A10, A10E, A12, A12E, A14, A14E, E100, E120, E130, E150, E160, E170, KS1400B, KS1500B, P360, P390							
<b>ASGATEC</b>							
1400, 1600, 1801, 1840, 2001, 2040							
<b>BOSCH</b>							
AES 35, AKE 30B, AKE 30E, AKE 35B, AKE 35-16S, AKE 35-17, AKE 35-19Pro, AKE 40B, AKE 350B, GKE 35, GKE 35BC, GKE 35 BCE, PKE 10B, PKE 25, PKE 30B, PKE 35 PowerSharp, PKE 35B, PKE 40B, PKE 40BC, PKE 1350B, 1586.7							
<b>BUDGET</b>							
BBKS 1235							
<b>DOLMAR</b>							
101, 200, 201, 260, 290							
33, 40, 100, 100s, 102, 103, 104, 105, 108, 270, 271, 275, 285, 290, 295, ES 3, ES 6A, ES 30, ES 32A, ES 33A, ES 35, ES 37A, ES 38A, ES 40A (ab 09/01), ES 41A, ES 42A, ES 140, ES 151A, ES 152A, ES 153A, ES 160, ES 160A, ES 161A, ES 162A, ES 163A, ES 171A, ES 172A, ES 173A, ES 183A, ES 1600, ES 2030A, ES 2035A, ES 2040A, ES 2135A, ES 2140A, PS 33, PS 34, PS 36, PS 41, PS 45 (1,3mm), PS 39, PS 330, PS 340, PS 341, PS 342, PS 344, PS 350, PS 390, PS 400, PS 401, PS 3300TH, PS 3410, PS 3500TH, PS 3400TH, PS 3410TH							
104 PowerSharp							
<b>ECHO</b>							
CS 3400, CS 3450, CS 4400, CS 1550FT, CS 1850FT							





Fabrikant/machinetype	Zwaardlengte cm	Steek 	Aandrijf- schakels 	Aandrijf- schakeldikte 		kwb- code	Art.-nr.
<b>EFCO</b>							
136, 140							
<b>EINHELL</b>							
36GS, KSE 1435, KSE 1635, PE 35/3TS, PES 1435, PES 3000, PES 4000, PKS 1635, PKS 34/1AV, P35, RBK 3735, BG-PC 1235, BG-PC 3735, GH-EC 1835, RPC 3835, PES 40/3, PES 1435, PES 1540, PES 1640, PES 1540, PES 1640, PES 1840, KSE 1435, KSE 1635, KSE 1640, KSE 2000, KSE 3000, KSE 4000							
<b>EK</b>							
1535, Migros E 35, KSE 1435							
<b>FARM U. GARTEN</b>							
150EL							
<b>FLEURELLE</b>							
KS1435, KS1640, KSE1640, KSE1845, KSE2040-1, KSB2035, KSB2640							
<b>GARDENA</b>							
CST 3518, CST 3519-X							
<b>HITACHI</b>							
CS 350A, CS 350B							
<b>HOMELITE</b>							
i335, i3350B, D 3850B, D 3850BC, 23AV, Sabre S 3350B, S 1035, HCS 3435BA, CSP 3314, Bandit BSC 35, BanditXLX30, ECW 1636, HCS 3335, XL2 Super, XL, XEL, XLTI, 240SL							
<b>HURRICANE</b>							
HEK 18-35							
<b>HUSQUARNA</b>							
Husky 35, Hisky 36, 315, 316, 318, 320 Electric							
<b>IKRA</b>							
A104P+S, A204S, A205B, FA12, FA14, KS12, H014S, KS14, KS30ST, KS400, KS1200B, KS1250B, KS1300, Shark1300, KS1400, KS1400A,KS1400B, KS1500, KS1600, KS2000, 1200KS, Shark PE1400, Sup-Pro 1500, KS1500T, KS 1500TS, KS1700DL, KSE2000, EKS30, EKS35, EKS40, EKS1500-35, EKS1400, EKS1600, EKS1650, EKS1700, EKS1800, EKS2000, BKS301, BKS402, BKS4135, PKS40	35	3/8"	52	1,3	ø 4,0	A52	640352
KS14A, H014A, A104P PowerSharp							
KS1600-35, KS1600-40, KS1800-40, KSE2000-35, KSE2000-40, KSE2000-45, KS1500TS							
BKS4141							
KS1400T, KS1500T							
EL1400, Hobby Cutter, KS1200B, KS1250, KS1400A, KS1400T, KS1400TF, KS1435, KS1600T-35, KS1600TF-35,KS1600TS-35, KS14A, A104P PowerSharp							
<b>JONSERED</b>							
2036, 2040, 2033, 370, 380, CS2115EL, CS2120EL, CS2137							
<b>KOMATSU ZENOAH</b>							
G31AVS, G310TS, G3100, G3200, G3300, G380AVS, G3800, G2800AVS							
<b>MAKITA</b>							
Electric 5011B, Electric 5012B, Electric, 5014-NB, Electric 5016-B, Electric 5016-NB							
DCS 33, DCS 34, DCS 300, DCS 330, DCS 330S, DCS 330TH, DCS 340, DCS 341, DCS 342, DCS 344, DCS 350, DCS 380, DCS 390, DCS 400, DCS 401, DCS 3300TH, DCS 3400TH, DCS 3401TH, DCS 3500, DCS 3501, DCS 4610, DES 350, DES 400, UC 300, UC 3000, UC 3000A, UC 3001A, UC 3003A, UC 3500, UC 3500A, UC 3501A, UC 3503A, UC 4000, UC 4000A, UC 4001A, UC 4003A, 5014B, 5016B, 5016NB							
<b>MCCULLOCH</b>							
Mac 335, 435, MacCat 438							
<b>NAUTEC</b>							
131							
<b>OBI-CMI</b>							
CMI 1735BKS, 2115, EKS 1800-35							
<b>OBI-DIANA</b>							
1300-35KS							







Fabrikant/machinetype	Zwaardlengte cm	Steek 	Aandrijf- schakels 	Aandrijf- schakeldikte 		kwb- code	Art.-nr.
<b>OLEO MAC OLYM.</b>							
937							
931, 932, 932C							
935, 936, 940							
<b>OPEM</b>							
140Z, 142Z							
<b>PARTNER</b>							
330, 335, 340, 345, 350, 351, 357, 360, 365, 370, 371, 385, 389, 390, 405, P-420, P 740, P 842, P842CC							
1601,1602, 1612, 1613, 1614, 1616, 1618, 395, 420, 465							
<b>POULAN</b>							
25A, S 25D, S 25DA, 1400E, 2000, 2300AV, 2300CVA, P 600, 2050, 2150, 2250, 2450, 2550, Woodshark, Pro4016							
<b>RYOBI</b>							
CSP 3314, ECW 1636, PCN 3335, RCS 3335							
<b>SABRE</b>							
S 3350B, 1035, CS 35, BCS 35							
<b>SHINDAIWA-SDK-ISEKI</b>							
140, 160, 285s, 300s, 305s, 305AVZ, 340, 345, 346, 350, 352s, 355, 357s, 360, 377, 391, 395, A-090, 102, 103, 104, 105, 107, 110, 110P, 113L+P, 117P, 100, E 150, 315, YB 301, YB 401, A 090B, A 100C, A 102, A 150B	35	3/8"	52	1,3	ø 4,0	A52	640352
<b>SHINGU</b>							
SP 3200, SP 3200T, SP 3400							
<b>SKIL</b>							
1600HE, 1601HE, 1602HE,1603H, 1604H, 1606H, 1610U, 1612U, 1616U, 1620U, 1634U, 1636U, 1712U							
<b>SOLO</b>							
613, 614, 620, 630, 633, 635, 635ECO, 636, 637, 640, 643							
<b>TALON</b>							
AC2101, AC2105, AC2109, AC2111, AC3100							
<b>TAS-TANAKA</b>							
290, 300, ECS 320, ECS 330, ECS 3301, ECS 3351, ECS 3401, TCS 3301S, TCS 3401							
<b>TURBO SILENT</b>							
BKS3536							
<b>UNIROPA</b>							
KSE2035, KSI1800-35, KSE2040, KSI20-40							
<b>VARIOLUX</b>							
2135KSE, 2140KSE, 2335BKES, 2340BKES							
<b>ZENOAH</b>							
G 310TS, G 320AV, G 320AVS, G 3100, G 3200							





Fabrikant/machinetype	Zwaardlengte cm	Steek 	Aandrijf- schakels 	Aandrijf- schakeldikte 		kwb- code	Art.-nr.
<b>ALPINA-CASTOR</b> EL140, EL160, EL170, 300, 330, 380, 423, 432, 438, CP34S, P34, P34S, P350, P380, P438, PR350, PR370, Euro35, Euro40, Euro45, KS300, KS350, CX35, CX40, CX 45, Energie 1.6, E1.8, Jolly40 Garden Ranger	40	3/8"	55	1,3	ø 4,0	A55	640355
<b>BLACK &amp; DECKER</b> CS30, CS35, D35KS, D40KS, DN301, DN302, DN400, DN401, DN402, DN402/B, DN404, DN404/B, DN404-TypH2, DN410, DN412, DN416, DN 430, GK30, GK40, GK100/110, GK120, GK130, GK300, GK31, GK310, GK320, GK321, GK322, GK330, GK331, GK3300, GK35, GK42, GK43, GK430, GK425, GK435, GK440, GK535, GK540, 5400, 8308, 8310, 8312, 8314, GK1300K, GK1330, GK1440, GK1530, GK1630T, GK1430, GK1435, GK1630 XC, GK1635, GK1830, Pro40							
<b>BONUS</b> KSE 2000 S							
<b>BUDGET</b> BKS 402							
<b>BULLKRAFT</b> KS 40S, KS 400S, KSE 1300B, KSM 40							
<b>EINHELL</b> PES 1840, REK 2040WK, PES 1540, PES 1640, BG-PC 4040							
<b>FLEURELLE</b> KSB 2340							
<b>GRIZZLY</b> EKS 2000, EKS 2000QT, BKS 38-16, BKS 35-14, BKS 38-14, EKS 1600, EKS 1800, EKS 400i, EKS 400TL, P390, BKS 350, BKS 400, KS 400i, KSI 2000							
<b>GRIZZLY-LIDL</b> Parkside EKS 1700							
<b>HURRICANE</b> ES 2040S							
<b>IKRA</b> BKS 38-16							
<b>LIDL</b> KSE1435, 1640, PKS 2000/4							
<b>MCCULLOCH</b> Electramac 240, 316, 316a, 340E, 1040, ES28, S16, Mac 538, 538e, 539e, 540, 540e, 545, 545e, 546, 838, 940, Mac Cat 839, California, California 2000/Kit, KSB2340, Mac6, Mac6B, Mac740, Mac940, PM486, EM30, Mac12, Mac28, MiniMac832, Titan7							
<b>MCCULLOCH</b> Electramac 16-EE, ES 30, 22, 24, 26, 35, 36, 40, PM-394, PM-494, M 1, 2, 2B, 4, 4B, 6, 6B, Californian, Arizona, Eager-Beaver, 10, 12, 12 A/S, 14 AVS, 16 E, 170, 374, 384, 394, 484, 494, 735, 930, 935, C 180, EM-8							
Mac110, 120, 130, 140, 160, PM300, PM310, PM320, PM330, PM340, PM360, PM364, PM370, PM380, PM394, PM470, PM474, PM480, PM484, PM494, PM530, PM538, PM540, 832, 833, 835, 836, 838, 839, 930, Euromac S32, S33, S34, S36, S40, S41, ELECTR							
<b>PARKSIDE</b> KSE1435, KSE1640, EKS1650, 1700PKS40, 2000							
<b>PARTNER</b> P1535, P1550, 1640, P1850, P538, 538E							
<b>RYOBI</b> 35B, CS 36C, CS 41, CSE 330, CSE 3330, CSE 385CB, HC 31, HCS 31, HC 36, HC 41, CS 1530, CS 1535, CS 1540 CS 41, HC 41, CS1540							
<b>STARK-SYMPRA-SYMPRATEC</b> 1416, 1500, 1600, 1616, 1440, 14840, 16840							
<b>STIHL</b> 009, 010, 011, 012, 015, 018C, 019, 020, 020/T, 021, 023, 023C, 023L, 025, 025C, E 10, E 14, E 20, E 140, E 160, E 180, E 180C, E 220, E 220C, MS 180C, MS 190, MS 190T, MS 200, MS 200T, MS 210, MS 211, MS 230, MS 250, MSE 160, MSE 180, MSE 200, AVH-Elektronic							
<b>TALON</b> AC2101, AC2105, AC2109, AC2111, AC3100							





Fabrikant/machinetype	Zwaardlengte cm	Steek 	Aandrijf- schakels 	Aandrijf- schakeldikte 		kwb- code	Art.-nr.
<b>ALDI</b>							
Kingkraft KSI2000-40, KS1500B, EKS1700, EKS1750							
<b>ALKO</b>							
KE 40-16, KE 1750, KSB 40/40 II, BKS 40/40II							
E 25A, E 1200 S, E 125, E 1400, E 1500, EK 25 A, KB 3500, KB 4000, KB 4001, KB 4500, KB 4501, KE 14, KE 16, KE 18, KSB 1450, P11, P12, 2000, 2300, 3000, KS, KSB, Elektro							
<b>ALPINA-CASTOR</b>							
EL140, EL160, EL170, 300, 330, 380, 423, 432, 438, CP34S, P34, P34S, P350, P380, P438, PR350, PR370, Euro35, Euro40, Euro45, KS300, KS350, CX35, CX40, CX 45, Energie 1.6, E1.8, Jolly40 Garden Ranger							
<b>BLACK &amp; DECKER</b>							
CS30, CS35, D35KS, D40KS, DN301, DN302, DN400, DN401, DN402, DN402/B, DN404, DN404/B, DN404-TypH2, DN410, DN412, DN416, DN 430, GK30, GK40, GK100/110, GK120, GK130, GK300, GK31, GK310, GK320, GK321, GK322, GK330, GK331, GK3300, GK35, GK42, GK43, GK430, GK425, GK435, GK440, GK535, GK540, 5400, 8308, 8310, 8312, 8314, GK1300K, GK1330, GK1440, GK1530, GK1630T, GK1430, GK1435, GK1630 XC, GK1635, GK1830, Pro40 GK1640T, GK1640TG, GK1640XC, GK1740X, GK2040T, GT1640TX							
<b>BULLKRAFT</b>							
KS 400, KS 400/2, KS 400/3							
<b>CASTEL GARDEN</b>							
XC 36P, XC 37, XC 18EL, XC 20EL							
<b>CASTORAMA</b>							
Cast TPE 40							
<b>DOLMAR</b>							
33, 40, 100, 100s, 102, 103, 104, 105, 108, 270, 271, 275, 285, 290, 295, ES 3, ES 6A, ES 30, ES 32A, ES 33A, ES 35, ES 37A, ES 38A, ES 40A (ab 09/01), ES 41A, ES 42A, ES 140, ES 151A, ES 152A, ES 153A, ES 160, ES 160A, ES 161A, ES 162A, ES 163A, ES 171A, ES 172A, ES 173A, ES 183A, ES 1600, ES 2030A, ES 2035A, ES 2040A, ES 2135A, ES 2140A, PS 33, PS 34, PS 36, PS 41, PS 45 (1,3mm), PS 39, PS 330, PS 340, PS 341, PS 342, PS 344, PS 350, PS 390, PS 400, PS 401, PS 3300TH, PS 3410, PS 3500TH, PS 3400TH, PS 3410TH	40	3/8"	56	1,3	ø 4,0	A56	640356
<b>EINHELL</b>							
BG-EC 2240, RG-EC 2240 MG, REC 2240 TC, GH-EC 2040							
<b>FARM U. GARTEN</b>							
160EL, 165EL, 170EL, 180EL, 360P, 370P, 390P							
<b>GRIZZLY</b>							
BKS 35-14, BKS 35-38, BKS 35-40, BKS 38-14, BKS 38-16, PKS 360/390, EKS 1600, EKS 1700-40, EKS 1800, EKS 400I, EKS 400TL, EKS 2000, P390, BKS 350, BKS 400, KSI 2000							
<b>HOMELITE</b>							
2014B, 20AV, HCS 3435BA, ECW 1641							
<b>HERKULES</b>							
1/41							
<b>HUSQUARNA</b>							
Husky 35, Hisky 36, Husky 37, Husky 41, 315, 316, 318, 320 Electric							
<b>IKRA</b>							
A104P+S, A204S, A205B, FA12, FA14, KS12, H014S, KS14, KS30ST, KS400, KS1200B, KS1250B, KS1300, Shark1300, KS1400, KS1400A,KS1400B, KS1500, KS1600, KS2000, 1200KS, Shark PE1400, Sup-Pro 1500, KS1500T, KS 1500TS, KS1700DL, KSE2000, EKS30, EKS35, EKS40, EKS1500-35, EKS1400, EKS1600, EKS1650, EKS1700, EKS1800, EKS2000, BKS301, BKS402, BKS4135, PKS40 KS1400B-40, KS1500B-40, KSB3940, MKS 40, Peifi Cutter, SEK 618							
<b>JONSERED</b>							
2036, 2040, 2033, 370, 380, CS2115EL, CS2120EL, CS2137							
<b>KINGCRAFT</b>							
KS1500B							





Fabrikant/machinetype	Zwaardlengte cm	Steek 	Aandrijf- schakels 	Aandrijf- schakeldikte 		kwb- code	Art.-nr.							
<b>MCCULLOCH</b> Electramac 16-EE, ES 30, 22, 24, 26, 35, 36, 40, PM-394, PM-494, M 1, 2, 2B, 4, 4B, 6, 6B, Californian, Arizona, Eager-Beaver, 10, 12, 12 A/S, 14 AVS, 16 E, 170, 374, 384, 394, 484, 494, 735, 930, 935, C 180, EM-8 MacCat 440, 441, 442	40	3/8"	56	1,3	ø 4,0	A56	640356							
<b>OBIDIANA</b> 1400-40KS														
<b>OLEO MAC OLYM.</b> 936, 940C, E140														
<b>PARKSIDE</b> KSE1435, KSE1640, EKS1650, 1700PKS40, 2000														
<b>PARTNER</b> 1400E, 1500-EL, 1601, 1602, 1612, 1613, 1614, 1616, 1618 330, 335, 340, 345, 350, 351, 357, 360, 365, 370, 371, 385, 389, 390, 405, P-420, P 740, P 842, P842CC														
<b>PEUGEOT</b> TLS 1630, TRC 1630, TLS 1635, TLS 1635A, TRC 1635, TLS 1640, TRC 1640, EKS1740														
<b>POULAN</b> 2050, 2150, 2250, 2450, 2550, Woodshark, Pro4016														
<b>RYOBI</b> CSN 410, ECW 1641, HCS 340BA														
<b>SOLO</b> 662, KSB 2640														
<b>STAYER</b> SEC 40														
<b>STIGA</b> SE 1.8, SE180, SE 190, SE 200Q, SP 370, SP 410, SPR 350 DPC-1316														
<b>TOPCRAFT</b> KSI2000-40, EKS1700, EKS1750, EKS1800														
<b>TURBO SILENT</b> BKS4041														
<b>AEG</b> KS 40								40	3/8"	57	1,3	ø 4,0	A57	640357
<b>ALDI</b> TopCraft EKS 1700, EKS 1800, EKS 1750														
<b>ALKO</b> KE1000, 3000, 3500, 3500Vario, 4000, KE40-18, KE1600/40, KE1750/40, KE2200/40 E 25A, E 1200 S, E 125, E 1400, E 1500, EK 25 A, KB 3500, KB 4000, KB 4001, KB 4500, KB 4501, KE 14, KE 16, KE 18, KSB 1450, P11, P12, 2000, 2300, 3000, KS, KSB, Elektro														
<b>ALPINA-CASTOR</b> A10, A10E, A12, A12E, A14, A14E, E100, E120, E130, E150, E160, E170, KS1400B, KS1500B, P360, P390 CP55, CP65, CP66, Prof.55, Prof.60, 540, 600, P700, 800														
<b>ASGATEC</b> 1400, 1600, 1801, 1840, 2001, 2040														
<b>ATIKA</b> KS 2001/40														
<b>BLACK &amp; DECKER</b> GK1940T, GK 2240T														
<b>BOSCH</b> AES 35, AKE 30B, AKE 30E, AKE 35B, AKE 40B, AKE 40-16S, AKE 40-19Pro, GKE 40B, GKE 40BC, GKE 40 BCE, PKE 10B, PKE 25, PKE 30B, PKE 35B, PKE 40, PKE 40B, PKE 40BC, PKE 1350B, 1586.8														
<b>BUDGET</b> BEKS 1840, BKS 401, BKS 402														
<b>CMI</b> KS1840, 2040 KS														
<b>DEFORT</b> DEC-1645N, DEC-2045N DPC-1316														

Fabrikant/machinetype	Zwaardlengte cm	Steek 	Aandrijf- schakels 	Aandrijf- schakeldikte 		kwb- code	Art.-nr.
<b>DYNAMAC</b>							
DY 36, DY 19E							
<b>ECHO</b>							
CS 3400, CS 3450, CS 4400, CS 1550FT, CS 1850FT							
<b>EFCO</b>							
136, 140							
117E, 119E							
<b>EINHELL</b>							
41, 40A, BG-EC-840TC, BG-EC 1840, BG-EC 1840 TC, BG-EC 2040S, BG-EC 2240, BG-PC 4040, CS 38, EKS 1840, EKS 2040, EKS 2040/1P, 2040P, KS 1800-40, KSE 1435, KSE 1635, KSE 1640, KSE 1740, KSE 2000, KSE 3000, KSE 4000, MKS 34, MKS 40AV, NKS 2000, PCS 3840, PES 1435, PES 1540, PES 1640, PES 1740, PES 1840, PES 40/3, PES 40S, PES 4000, PKS 1840, PKS 2000, PKS 2040, PKS 2040 WK, PKS 40/1AV, RBK 4040, REK 1840, RG-EC 2040, RG-EC 2240, RG-EC 2240 TC, RPC 4640, RPC 2040, REC 1840, REK 1840/1, REK 184, REK 2048, Turbo-Silent							
<b>FLEURELLE</b>							
KS1435, KS1640, KSE1640, KSE1845, KSE2040-1, KSB2035, KSB2640							
<b>GARDENA</b>							
CST 4020-X							
<b>GRIZZLY</b>							
BKS 35-14, BKS 38-14, BKS 38-16, EKS 400I, EKS 400TL, EKS 1600, EKS 1800, EKS 1800-40, EKS 1850, EKS 2000, EKS 2000-6, EKS 2000-6QT, P390, BKS 350, BKS 400, KSI 2000							
<b>GÜDE</b>							
KS 400E							
<b>HANSEATIC</b>							
1840 KS, 2040 KS	40	3/8"	57	1,3		A57	640357
<b>HERKULES</b>							
18/41							
<b>HITACHI</b>							
CS 35B							
<b>HOMELITE</b>							
CSP 4016							
<b>HURRICANE</b>							
PS 200-40E							
<b>IKRA</b>							
A104P+S, A204S, A205B, FA12, FA14, KS12, H014S, KS14, KS30ST, KS400, KS1200B, KS1250B, KS1300, Shark1300, KS1400, KS1400A, KS1400B, KS1500, KS1600, KS2000, 1200KS, Shark PE1400, Sup-Pro 1500, KS1500T, KS 1500TS, KS1700DL, KSE2000, EKS30, EKS35, EKS40, EKS1500-35, EKS1400, EKS1600, EKS1650, EKS1700, EKS1800, EKS2000, BKS301, BKS402, BKS4135, PKS40							
KSI1600-35, KSI1600-40, KSI1800-40, KSE2000-35, KSE2000-40, KSE2000-45, KS1500TS							
KS1400T, KS1500T							
KS1600T							
<b>IKRA</b>							
KS1640, BKS401, KSI2000-40, SWING1840KS, 2140KSE, Variolux, SWING2040KS, CMI2040S, Hanseatic 1840KSM, KSE2040, KS1600T-40, KS2000TF, KS2000TS, KS1600TF-40, 1640Shark, KF1800TF-40, KF1800TS-40, KS1400T/TS, KS1640, KS1800TF/TS, PKS40, KS2000TF/TS							
<b>KINGCRAFT</b>							
EKS1650, KSI2000-40							
<b>KOMATSU ZENOAH</b>							
G31AVS, G310TS, G3100, G3200, G3300, G380AVS, G3800, G2800AVS							

... altijd de passende toebehoren voor uw machine!





Fabrikant/machinetype	Zwaardlengte cm	Steek 	Aandrijf- schakels 	Aandrijf- schakeldikte 		kwb- code	Art.-nr.
<b>MAKITA</b> Electric 5011B, Electric 5012B, Electric, 5014-NB, Electric 5016-B, Electric 5016-NB DCS 33, DCS 34, DCS 300, DCS 330, DCS 330S, DCS 330TH, DCS 340, DCS 341, DCS 342, DCS 344, DCS 350, DCS 380, DCS 390, DCS 400, DCS 401, DCS 3300TH, DCS 3400TH, DCS 3401TH, DCS 3500, DCS 3501, DCS 4610, DES 350, DES 400, UC 300, UC 3000, UC 3000A, UC 3001A, UC 3003A, UC 3500, UC 3500A, UC 3501A, UC 3503A, UC 4000, UC 4000A, UC 4001A, UC 4003A, 5014B, 5016B, 5016NB ES 2000-400, EK 2000-400	40	3/8"	57	1,3		A57	640357
<b>MATRIX</b> ES2000-400, EK2000-400							
<b>MAX BAHR</b> Bahr 2000, Bonus 1800, EKS 1800-40, KSI 2000-40							
<b>METABO</b> KT 1441, KT1440							
<b>OBI-CMI</b> CMI 2040KS/KSI, 2040KSS, BKS45, KS 1840/1, KS 2000							
<b>O.K.</b> EKS 1840							
<b>OLEO MAC OLYM.</b> 935, 936, 940							
<b>OPEM</b> 140Z, 142Z							
<b>POULAN</b> 25A, Micro 25, S 25 CVA, S 25D, S 25DA, 1800, 2000, 2300AV, 2300CVA, P 600							
<b>PROVIL</b> PVKS 2000E, PVKS 2000/1E							
<b>RYOBI</b> HCS 3435BA							
<b>SHINDAIWA-SDK-ISEKI</b> 140, 160, 285s, 300s, 305s, 305AVZ, 340, 345, 346, 350, 352s, 355, 357s, 360, 377, 391, 395, A-090, 102, 103, 104, 105, 107, 110, 110P, 113L+P, 117P, 100, E 150, 315, YB 301, YB 401, A 090B, A 100C, A 102, A 150B 1600 ES							
<b>SHINGU</b> SP 3400							
<b>SKIL</b> 1600HE, 1601HE, 1602HE, 1603H, 1604H, 1606H, 1610U, 1612U, 1616U, 1620U, 1634U, 1636U, 1712U							
<b>SOLO</b> 613, 614, 620, 630, 633, 635, 635ECO, 636, 637, 640, 643							
<b>SWING</b> 1840KS, 2040KS							
<b>TAS-TANAKA</b> 290, 300, ECS 320, ECS 330, ECS 3301, ECS 3351, ECS 3401, TCS 3301S, TCS 3401							
<b>TOPCRAFT</b> KSI2000-40, EKS1700, EKS1750, EKS1800							
<b>TURBO SILENT</b> EKS2040							
<b>UNIROPA</b> KSE2035, KSI1800-35, KSE2040, KSI20-40							
<b>VARIOLUX</b> 2135KSE, 2140KSE, 2335BKS, 2340BKS							
<b>ZENOAH</b> G 380AV, G 380AVS, G 3800AVS							



Fabrikant/machinetype	Zwaardlengte cm	Steek 	Aandrijf- schakels 	Aandrijf- schakeldikte 		kwb- code	Art.-nr.
<b>ALPINA CASTOR</b> PS 34, PS 34S	<b>30</b>	3/8"	44	1,1	ø 4,8	C44	<b>640644</b>
<b>SHINDAIWA-SDK-ISEKI</b> SBA-P230							
<b>STIHL</b> 009, 017, 018, 019/T, 23L, E 140, MS 170, MS 171C, MS 180, MS 181, MS 190T, MS 192, MS 192T, E14, MSE 140, HT 70/75							
<b>TAS-TANAKA</b> TPS 2501, TPS 2501S, TPS 2510, RPS 200H							
<b>EFCO</b> 115E							
<b>OLEO MAC OLYM.</b> E 1500							
<b>STIHL</b> 009, 017, 018, 019/T, 23L, E 140, MS 170, MS 171C, MS 180, MS 181, MS 190T, MS 192, MS 192T, E14, MSE 140, HT 70/75	<b>35</b>	3/8"	50	1,1	ø 4,8	C50	<b>640650</b>
<b>BOSCH</b> AKE 30-17S, AKE 35, AKE 35-17S, AKE 35-18S, AKE 35-19S, AKE 40-17S							
<b>DOLMAR</b> ES-5A, ES 36A, ES 37A, ES 38A, PS 34							
<b>MAKITA</b> EL-UC 210R, DCS 34, UC 3010A, UC 3510U, DCS3400, DCS 3410, UC 4010A							
<b>PARTNER</b> 1436, 1641							
<b>POULAN</b> E 5300							
<b>SOLO</b> 633, 636-Microlite	<b>38</b>	.325	64	1,3	ø 4,8	D64	<b>640864</b>
<b>ALPINA-CASTOR</b> P410							
<b>CASTEL GARDEN</b> XC 41							
<b>DOLMAR</b> PS-410, PS-411, PS-420, PS420C							
<b>DYNAMAC</b> DY 41							
<b>EFCO</b> 138, 141							
<b>HOMELITE</b> i3850B, D 4550B, D 3850BC, EZ-AO-130/150/290/340, XL- 76/100/250, VI-123/125, VISuper Mini							
<b>HUSQUARNA</b> 33, 36, 40, 41, 42, 44,45, 49, 51, 55, 131, 136, 141, EL1200, E1400, E1600, EL16, 136, 137 e-serie, 140, 141, 142 e-serie, 340, 345, 346, 350, 351, 242XP							
<b>JONSERED</b> 2016, 2036, 2040, 2041, 2045, 2050, 2054, 2055, CS2147, CS2152							
<b>MAKITA</b> DCS 410, DCS 411, DCS 4301, DCS 440, DCS 441, DCS 430, DCS 520, DCS 4300i, DCS 5200i							
<b>MAFELL</b> EKS400S							
<b>MCCULLOCH</b> PM 3500, 4000, 400-P, 4500, 4700, 4900, 5000, Titan 35+40, Logger-Kit, 3500, 400P, T 35, T 40, PM 38, 40-46, T 46, T 48, ProMac 10-42, ProMac 10-49Pro, ProMac 40, ProMac 40II, ProMac 46, ProMac 46II, Timber							
<b>NAUTEC</b> 138							

Fabrikant/machinetype	Zwaardlengte cm	Steek 	Aandrijf- schakels 	Aandrijf- schakeldikte 		kwb- code	Art.-nr.
<b>OLEO MAC OLYM.</b> 240, E 170, E170F 945, 950, 938, 941	<b>38</b>	.325	64	1,3	ø 4,8	D64	<b>640864</b>
<b>PARTNER</b> P-21, 26, 28, 360, 365, 400, 405, 410, 411, 450, 460, P461, P461II, 462, P470, 500, P510, 511, 540, 543, 1074, 5000, EL 1450, EL 1650							
<b>POULAN</b> 2800, 2900, 3300, 3350							
<b>SHINDAIWA-SDK-ISEKI</b> 360, 366, 370, 394, 400, 415, 416, 420, 450, 451, 457, 488, 495, 500, 506, 510, 560, 601, 691, A-180B, YB 501, YB 601, YB 701							
<b>SOLO</b> 634, 639, 645							
<b>STIGA</b> SP 410, SP 370							
<b>ZENOAH</b> G 415AVS-16							
<b>STIHL</b> 024/WB, 025, 026/C/W/CW/WB/WVH, 028, 028/S/WB/AV/EQ, MS 240, MS 260, MS 270, MS 280							
<b>BOSCH</b> 1535							
<b>DOLMAR</b> 105, 108, 109, 110, 110i, 111, 112, 113, 113CA, 114, 115, 115i, 115iH, 116, 116si, 117, 118, 119, 120, 120Si, 120super, 219, PS43, PS52, PS6000iH, PS6000i, PS6800i, PS6800iH, PS9000, PS6000, PS6800 PS 460(3/8"), PS 500(3/8"), PS 52, PS 5000(3/8") PS5000, PS6400, PS7300, PS7900, PSW6400H, PS7300H, PS79004, 153, 152, 144, PS 9010							
<b>HUSQUARNA</b> 61, 75, 77, 162, 163, 181, 246, 262, 263, 266, 268, 272, 280, 281, 285, 286, 288, 289, 298, 365, 371, 380, 480 (XP/XPG), 61, 65, 66, 1100, 2100, 2100XP, 2101, 25XP, 245XPG, 254XP, 254XPG, 27, 262, 264, 288XPG, 338XPT, 334T, 365, 372XP, 385XP, 394XPG, 395XP, 395XPG, 3120XP, 55							
<b>JONSERED</b> CS2156, CS2159, CS2163, CS2165, CS2171							
<b>MAKITA</b> DCS 43, DCS 52, DCS 430, DCS 431, DCS 460, DCS 461, DCS 480, DCS 500, DCS 501, DCS 520, DCS 520i, DCS 4300, DCS 4600S, DCS 4600SH, DCS 5000, DCS 5001, DCS 5000H, DCS 5200i, DCS 6600, DCS 6000i, DCS 6400, DCS 6800, DCS 6800i, DCS 7300, DCS 7900							
<b>MCCULLOCH</b> Mac 950, 951, 955, 960, 961, 970, Pro Mac 51, 55, 60, 61, 72, Titan 51, 61, Topso							
<b>OLEO MAC OLYM.</b> 250, 250A, 251, 251B, 251S, 252, 254, 260, 261, 264, 271, 272, 280, 284, 350, 350S, 355, 460, 480, 481, 482, 484, E 300, OM-E 300, 956, 962, 970, 980							
<b>PARTNER</b> P 500, 605, P 5000							
<b>PARTNER</b> 550, 650, 660, 1633-B, F 55, F 65, P-55, 65, 70, 85, 7000, R-11, 12, 14, R-16, 17, 18, 19, 20, 21, R-22, 30, 40, 417, 418, R-420, 421,422, 435, R-440, 522, 523, S-50, 55, 65, 660, P-7700							
<b>SOLO</b> 662, 670, 680, 690							
<b>STIHL</b> 029, 030, 031, 032, 034/S, 036/W/WVH, 036QS, 038, 039, 041, 042, 044, 045, 046, 048, 056, 064, E-10, E-16, E-20, E-220, MS 290, MS 310, MS 360/C, MS 390, MS 440/C, MS 460/C, MS 660							
<b>40</b>	3/8"	60	1,6	ø 4,8	M60	<b>641860</b>	







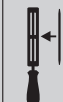



# Zaagkettingen gesorteerd volgens fabrikant

Fabrikant/machinetype	Zwaardlengte cm	Steek 	Aandrijf- schakels 	Aandrijf- schakeldikte 		kwb- code	Art.-nr.
<b>AEG</b>							
KS 30	30	3/8"	45	1,3	ø 4,0	A45	640345
KSE 35, KS 35	35	3/8"	52	1,3	ø 4,0	A52	640352
KS 40	40	3/8"	57	1,3	ø 4,0	A57	640357
<b>ALDI</b>							
	35	3/8"	49	1,3	ø 4,0	A49	640349
	40	3/8"	55	1,3	ø 4,0	A55	640355
Kingkraft KSI2000-40, KS1500B, EKS1700, EKS1750	40	3/8"	56	1,3	ø 4,0	A56	640356
TopCraft EKS 1700, EKS 1800, EKS 1750	40	3/8"	57	1,3	ø 4,0	A57	640357
<b>ALKO</b>							
Hobby 320, E135, E1200E, 1400E, 1500E	30	3/8"	44	1,3	ø 4,0	A44	640344
	30	3/8"	44	1,3	ø 4,0	A44	640344
KB350, KB450, 3500, 4000, 4500, KB3501, 4001, 5001	35	3/8"	49	1,3	ø 4,0	A49	640349
KE1800/35, KE4000Vario	35	3/8"	50	1,3	ø 4,0	A56	640356
BKS 35/35 II, KE 2000/35, KE40-16/11, KE1400/35, KE1600/35	35	3/8"	52	1,3	ø 4,0	A52	640352
KE 40-16, KE 1750, KSB 40/40 II, BKS 40/40II	40	3/8"	56	1,3	ø 4,0	A56	640326
KE1000, 3000, 3500, 3500Vario, 4000, KE40-18, KE1600/40, KE1750/40, KE2200/40	40	3/8"	57	1,3	ø 4,0	A57	640357
	30	3/8"	44	1,3	ø 4,0	A44	640344
	30	3/8"	45	1,3	ø 4,0	A45	640345
E 25A, E 1200 S, E 125, E 1400, E 1500, EK 25 A, KB 3500, KB 4000, KB 4001, KB 4500, KB 4501, KE 14, KE 16, KE 18, KSB 1450, P11, P12, 2000, 2300, 3000, KS, KSB, Elektro	35	3/8"	50	1,3	ø 4,0	A50	640350
	35	3/8"	52	1,3	ø 4,0	A52	640352
	40	3/8"	56	1,3	ø 4,0	A56	640356
	40	3/8"	57	1,3	ø 4,0	A57	640357
<b>ALPINA-CASTOR</b>							
PS 34, PS 34S	30	3/8"	44	1,1	ø 4,8	C44	640644
	30	3/8"	45	1,3	ø 4,0	A45	640345
A10, A10E, A12, A12E, A14, A14E, E100, E120, E130, E150, E160, E170, KS1400B, KS1500B, P360, P390	35	3/8"	50	1,3	ø 4,0	A50	640350
	35	3/8"	52	1,3	ø 4,0	A52	640352
	40	3/8"	57	1,3	ø 4,0	A57	640357
	30	3/8"	44	1,3	ø 4,0	A44	640344
EL140, EL160, EL170, 300, 330, 380, 423, 432, 438, CP34S, P34, P34S, P350, P380, P438, PR350, PR370, Euro35, Euro40, Euro45, KS300, KS350, CX35, CX40, CX 45, Energie 1.6, E1.8, Jolly40 Garden Ranger	35	3/8"	49	1,3	ø 4,0	A49	640349
	35	3/8"	50	1,3	ø 4,0	A50	640350
	40	3/8"	55	1,3	ø 4,0	A55	640355
	40	3/8"	56	1,3	ø 4,0	A56	640356
CP55, CP65, CP66, Prof.55, Prof.60, 540, 600, P700, 800 P410	40	3/8"	57	1,3	ø 4,0	A57	640357
	38	.325	64	1,3	ø 4,8	D64	640864
<b>ASGATEC</b>							
1400, 1600, 1801, 1840, 2001, 2040	35	3/8"	52	1,3	ø 4,0	A52	640352
	40	3/8"	57	1,3	ø 4,0	A57	640357
<b>ATIKA</b>							
KS 2001/40	40	3/8"	57	1,3	ø 4,0	A57	640357
<b>BLACK &amp; DECKER</b>							
CS30, CS35, D35KS, D40KS, DN301, DN302, DN400, DN401, DN402, DN402/B, DN404, DN404/B, DN404-TypH2, DN410, DN412, DN416, DN 430, GK30, GK40, GK100/110, GK120, GK130, GK300, GK31, GK310, GK320, GK321, GK322, GK330, GK331, GK3300, GK35, GK42, GK43, GK430, GK425, GK435, GK440, GK535, GK540, 5400, 8308, 8310, 8312, 8314, GK1300K, GK1330, GK1440, GK1530, GK1630T, GK1430, GK1435, GK1630 XC, GK1635, GK1830, Pro40	30	3/8"	44	1,3	ø 4,0	A44	640344
	30	3/8"	45	1,3	ø 4,0	A45	640345
	35	3/8"	49	1,3	ø 4,0	A49	640349
	40	3/8"	55	1,3	ø 4,0	A55	640355
	40	3/8"	56	1,3	ø 4,0	A56	640356
GK1430, GK1300	30	3/8"	44	1,3	ø 4,0	A44	640344
GK1635TX, GK1635TG, GK1435	35	3/8"	49	1,3	ø 4,0	A49	640349
GK1640T, GK1640TG, GK1640XC, GK1740X, GK2040T, GT1640TX	40	3/8"	56	1,3	ø 4,0	A56	640356
L10	30	3/8"	45	1,3	ø 4,0	A45	640345
	35	3/8"	49	1,3	ø 4,0	A49	640349
GK1940T, GK 2240T	40	3/8"	57	1,3	ø 4,0	A57	640357





Fabrikant/machinetype	Zwaardlengte cm	Steek 	Aandrijf- schakels 	Aandrijf- schakeldikte 		kwb- code	Art.-nr.
<b>BEL PICKPINE</b>							
16	30	3/8"	44	1,3	ø 4,0	A44	640344
34, 16	35	3/8"	49	1,3	ø 4,0	A49	640349
<b>BLITZ</b>							
B 300, B 304, B 34, E 140F	30	3/8"	44	1,3	ø 4,0	A44	640344
B 35D, B 38	35	3/8"	49	1,3	ø 4,0	A49	640349
<b>BONUS</b>							
KSB 35	35	3/8"	49	1,3	ø 4,0	A49	640349
KSE 2000 S	40	3/8"	55	1,3	ø 4,0	A55	640355
<b>BOSCH</b>							
AKE 30, AKE 30-17S, AKE 30-18S	30	3/8"	45	1,1	ø 4,8	C45	640645
AKE 30-17S, AKE 35, AKE 35-17S, AKE 35-18S, AKE 35-19S, AKE 40-17S	35	3/8"	52	1,1	ø 4,0	C52	640652
EKS 1535, 1540, KS 300	30	3/8"	44	1,3	ø 4,0	A44	640344
AES 35, AKE 30B, AKE 30E, AKE 30-19Pro, AKE 30-16S, AKE 35B, AKE 40B, AKE 300B, PKE 10B, PKE 25, PKE 30 PowerSharp, PKE 30B, PKE 35B, PKE 40B, PKE 40BC, PKE 1350B, GKE 35BC, 1586	30	3/8"	45	1,3	ø 4,0	A45	640345
AES 35, AKE 30B, AKE 30E, AKE 35B, AKE 35-16S, AKE 35-17, AKE 35-19Pro, AKE 40B, AKE 350B, GKE 35, GKE 35BC, GKE 35 BCE, PKE 10B, PKE 25, PKE 30B, PKE 35 PowerSharp, PKE 35B, PKE 40B, PKE 40BC, PKE 1350B, 1586.7	35	3/8"	52	1,3	ø 4,0	A52	640352
AES 35, AKE 30B, AKE 30E, AKE 35B, AKE 40B, AKE 40-16S, AKE 40-19Pro, GKE 40B, GKE 40BC, GKE 40 BCE, PKE 10B, PKE 25, PKE 30B, PKE 35B, PKE 40, PKE 40B, PKE 40BC, PKE 1350B, 1586.8	40	3/8"	57	1,3	ø 4,0	A57	640357
1535	38	3/8"	56	1,5	ø 4,8	L56	641756
<b>BUDGET</b>							
BKS 301	30	3/8"	45	1,3	ø 4,0	A45	640345
BBKS 1235	35	3/8"	52	1,3	ø 4,0	A52	640352
BKS 402	40	3/8"	55	1,3	ø 4,0	A55	640355
BEKS 1840, BKS 401, BKS 402	40	3/8"	57	1,3	ø 4,0	A57	640357
<b>BULLKRAFT</b>							
KSE 30, KS 300, KSE 1300B, GK 30, KSM 25, 300 S	30	3/8"	44	1,3	ø 4,0	A44	640344
KSE 1300B, BES 1300B, KS 350, KS 350/2	35	3/8"	49	1,3	ø 4,0	A49	640349
KS 40S, KS 400S, KSE 1300B, KSM 40	40	3/8"	55	1,3	ø 4,0	A55	640355
KS 350, KS 350/2, KS 400, KS 400/2	35	3/8"	50	1,3	ø 4,0	A50	640350
KS 400, KS 400/2; KS 400/3	40	3/8"	56	1,3	ø 4,0	A56	640356
<b>CASTEL GARDEN</b>							
XC 35P	30	3/8"	44	1,3	ø 4,0	A44	640344
XC 18EL, XC 20EL, XC 35P, XC 36, XC 37	35	3/8"	50	1,3	ø 4,0	A50	640350
XC 36P, XC 37, XC 18EL, XC 20EL	40	3/8"	56	1,3	ø 4,0	A56	640356
XC 41	38	.325	64	1,3	ø 4,8	D64	640864
<b>CASTORAMA</b>							
Cast TPE 40	40	3/8"	56	1,3	ø 4,0	A56	640356
<b>CMI</b>							
KS1840, 2040 KS	40	3/8"	57	1,3	ø 4,0	A57	640357
<b>DEFORT</b>							
DEC-1645N, DEC-2045N	40	3/8"	57	1,3	ø 4,0	A57	640357
DPC-1316	40	3/8"	57	1,3	ø 4,0	A57	640357
<b>DOLMAR</b>							
ES-5A, ES 36A, ES 37A, ES 38A, PS 34	35	3/8"	52	1,1	ø 4,0	C52	640652
	30	3/8"	45	1,3	ø 4,0	A45	640345
101, 200, 201, 260, 290	35	3/8"	50	1,3	ø 4,0	A50	640350
	35	3/8"	52	1,3	ø 4,0	A52	640352



# Zaagkettingen gesorteerd volgens fabrikant

Fabrikant/machinetype	Zwaardlengte cm	Steek 	Aandrijf- schakels 	Aandrijf- schakeldikte 		kwb- code	Art.-nr.
<b>DOLMAR</b>							
33, 40, 100, 100s, 102, 103, 104, 105, 108, 270, 271, 275, 285, 290, 295, ES 3, ES 6A, ES 30, ES 32A, ES 33A, ES 35, ES 37A, ES 38A, ES 40A (ab 09/01), ES 41A, ES 42A, ES 140, ES 151A, ES 152A, ES 153A, ES 160, ES 160A, ES 161A, ES 162A, ES 163A, ES 171A, ES 172A, ES 173A, ES 183A, ES 1600, ES 2030A, ES 2035A, ES 2040A, ES 2135A, ES 2140A, PS 33, PS 34, PS 36, PS 41, PS 45 (1,3mm), PS 39, PS 330, PS 340, PS 341, PS 342, PS 344, PS 350, PS 390, PS 400, PS 401, PS 3300TH, PS 3410, PS 3500TH, PS 3400TH, PS 3410TH	30	3/8"	46	1,3	ø 4,0	A46	640346
	35	3/8"	52	1,3	ø 4,0	A52	640352
	40	3/8"	56	1,3	ø 4,0	A56	640356
101 PowerSharp	30	3/8"	45	1,3	ø 4,0	A45	640345
104 PowerSharp	35	3/8"	52	1,3	ø 4,0	A52	640352
PS-410, PS-411, PS-420, PS420C	38	.325	64	1,3	ø 4,8	D64	640864
105, 108, 109, 110, 110i, 111, 112, 113, 113CA, 114, 115, 115i, 115iH, 116, 116si, 117, 118, 119, 120, 120Si, 120super, 219, PS43, PS52, PS6000iH, PS6000i, PS6800i, PS6800iH, PS9000, PS6000, PS6800	38	3/8"	56	1,5	ø 4,8	L56	641756
PS 460(3/8"), PS 500(3/8"), PS 52, PS 5000(3/8")	38	3/8"	56	1,5	ø 4,8	L56	641756
PS5000, PS6400, PS7300, PS7900, PSW6400H, PS7300H, PS79004, 153, 152, 144, PS 9010	38	3/8"	56	1,5	ø 4,8	L56	641756
	40	3/8"	60	1,5	ø 4,8	L60	641760
<b>DYNAMAC</b>							
30F, E 140F	30	3/8"	44	1,3	ø 4,0	A44	640344
35F	35	3/8"	49	1,3	ø 4,0	A49	640349
DY 36, DY 19E	40	3/8"	57	1,3	ø 4,0	A57	640357
DY 41	38	.325	64	1,3	ø 4,8	D64	640865
<b>ECHO</b>							
CS 200E, CS 280E, CS 280EVL, CS 290EVL, CS 300, CS 302, CS 320, CS 3000, CS 3050	30	3/8"	45	1,3	ø 4,0	A45	640345
CS 2700ES, CS 280EG, CS 330EVL, CS 350T, CS 3050, CS 3400, CS 3500	35	3/8"	53	1,3	ø 4,0	A53	640353
	35	3/8"	52	1,3	ø 4,0	A52	640352
	40	3/8"	57	1,3	ø 4,0	A57	640357
<b>EFCO</b>							
115E	35	3/8"	50	1,1	ø 4,8	C50	640650
131	30	3/8"	45	1,3	ø 4,0	A45	640345
	30	3/8"	45	1,3	ø 4,0	A45	640345
	35	3/8"	52	1,3	ø 4,0	A52	640352
	40	3/8"	57	1,3	ø 4,0	A57	640357
114E, 134, 135, 116	30	3/8"	44	1,3	ø 4,0	A44	640344
	35	3/8"	49	1,3	ø 4,0	A49	640349
<b>EFCO</b>							
117E, 119E	35	3/8"	50	1,3	ø 4,0	A50	640350
	40	3/8"	57	1,3	ø 4,0	A57	640357
138, 141	38	.325	64	1,3	ø 4,8	D64	640864
<b>EINHELL</b>							
CS 280, EKS 35, EKS 35-1, MKS 30, MKS 34, PE 34/2, PE 35/3ZS, PES 2000, PES 30/2, PES 30-2, PES 34/3, PES 34/2, PES 34/3, PES 35, PES 35/2TS, PES 35-2, PES 35-3, PES 40S, PKS 35-1AV, PES 40/3, PES 1435, PES 1540, PES 1640, PES 1540, PES 1640, PES 1840, KSE 1435, KSE 1635, KSE 1640, KSE 2000, KSE 3000, KSE 4000	30	3/8"	45	1,3	ø 4,0	A45	640345
AC 31114, BKS 38/35, MKS 35, PBK 35/35	35	3/8"	49	1,3	ø 4,0	A49	640349
MKS 35, PES 1435	35	3/8"	50	1,3	ø 4,0	A50	640350
36GS, KSE 1435, KSE 1635, PE 35/3TS, PES 1435, PES 3000, PES 4000, PKS 1635, PKS 34/1AV, P35, RBK 3735, BG-PC 1235, BG-PC 3735, GH-EC 1835, RPC 3835, PES 40/3, PES 1435, PES 1540, PES 1640, PES 1540, PES 1640, PES 1840, KSE 1435, KSE 1635, KSE 1640, KSE 2000, KSE 3000, KSE 4000	35	3/8"	52	1,3	ø 4,0	A52	640352
PES 1840, REK 2040WK, PES 1540, PES 1640, BG-PC 4040	40	3/8"	55	1,3	ø 4,0	A55	640355
BG-EC 2240, RG-EC 2240 MG, REC 2240 TC, GH-EC 2040	40	3/8"	56	1,3	ø 4,0	A56	640356





Fabrikant/machinetype	Zwaardlengte cm	Steek 	Aandrijf- schakels 	Aandrijf- schakeldikte 		kwb- code	Art.-nr.
<b>EINHELL</b>							
41, 40A, BG-EC-840TC, BG-EC 1840, BG-EC 1840 TC, BG-EC 2040S, BG-EC 2240, BG-PC 4040, CS 38, EKS 1840, EKS 2040, EKS 2040/1P, 2040P, KS 1800-40, KSE 1435, KSE 1635, KSE 1640, KSE 1740, KSE 2000, KSE 3000, KSE 4000, MKS 34, MKS 40AV, NKS 2000, PCS 3840, PES 1435, PES 1540, PES 1640, PES 1740, PES 1840, PES 40/3, PES 40S, PES 4000, PKS 1840, PKS 2000, PKS 2040, PKS 2040 WK, PKS 40/1AV, RBK 4040, REK 1840, RG-EC 2040, RG-EC 2240, RG-EC 2240 TC, RPC 4640, RPC 2040, REC 1840, REK 1840/1, REK 184, REK 2048, Turbo-Silent	40	3/8"	57	1,3	ø 4,0	A57	640357
<b>EK</b>							
1535, Migros E 35, KSE 1435	35	3/8"	52	1,3	ø 4,0	A52	640352
<b>EUROMAC</b>							
S 14/35/ES 35/ES 24/530, PM 370/374/470/474/735, Titan 35, E35	35	3/8"	50	1,3	ø 4,0	A50	640350
<b>FARM U. GARTEN</b>							
P349, PR350	30 35	3/8" 3/8"	44 50	1,3 1,3	ø 4,0 ø 4,0	A44 A50	640344 640350
150EL	35	3/8"	52	1,3	ø 4,0	A52	640352
160EL, 165EL, 170EL, 180EL, 360P, 370P, 390P	35 40	3/8" 3/8"	50 56	1,3 1,3	ø 4,0 ø 4,0	A50 A56	640350 640356
<b>FLEURELLE</b>							
KSB 1735	35	3/8"	49	1,3	ø 4,0	A49	640349
KS1435, KS1640, KSE1640, KSE1845, KSE2040-1, KSB2035, KSB2640	35	3/8"	52	1,3	ø 4,0	A52	640352
KSB 2340	40	3/8"	55	1,3	ø 4,0	A55	640355
KS1435, KS1640, KSE1640, KSE1845, KSE2040-1, KSB2035, KSB2640	40	3/8"	57	1,3	ø 4,0	A57	640357
<b>FOLUX</b>							
F 30F	30	3/8"	44	1,3	ø 4,0	A44	640344
F 35, F 35F	35	3/8"	49	1,3	ø 4,0	A49	640349
<b>FRONTIER</b>							
MK 1=Quadra	30	3/8"	45	1,3	ø 4,0	A45	640345
<b>GARDENA</b>							
CST 3518, CST 3519-X	35	3/8"	52	1,3	ø 4,0	A52	640352
CST 4020-X	40	3/8"	57	1,3	ø 4,0	A57	640357
<b>GRIZZLY</b>							
BKS 35-12	30	3/8"	44	1,3	ø 4,0	A44	640344
Farmer MKS 350, BKS 35-14, BKS 38-14, BKS 38-16, EKS 1600, EKS 1800, EKS 400i, EKS 400TL, EKS 2000, P390, BKS 350, BKS 400, KSI 2000	35	3/8"	49	1,3	ø 4,0	A49	640349
BKS 35-32, BKS 35-38, PKS 360/390, EKS 2500QT	35	3/8"	50	1,3	ø 4,0	A50	640350
EKS 2000, EKS 2000QT, BKS 38-16, BKS 35-14, BKS 38-14, EKS 1600, EKS 1800, EKS 400i, EKS 400TL, P390, BKS 350, BKS 400, KS 400i, KSI 2000	40	3/8"	55	1,3	ø 4,0	A55	640355
BKS 35-14, BKS 35-38, BKS 35-40, BKS 38-14, BKS 38-16, PKS 360/390, EKS 1600, EKS 1700-40, EKS 1800, EKS 400i, EKS 400TL, EKS 2000, P390, BKS 350, BKS 400, KSI 2000	40	3/8"	56	1,3	ø 4,0	A56	640356
BKS 35-14, BKS 38-14, BKS 38-16, EKS 400i, EKS 400TL, EKS 1600, EKS 1800, EKS 1800-40, EKS 1850, EKS 2000, EKS 2000-6, EKS 2000-6QT, P390, BKS 350, BKS 400, KSI 2000	40	3/8"	57	1,3	ø 4,0	A57	640357
<b>GRIZZLY-LIDL</b>							
Parkside EKS 1700	40	3/8"	55	1,3	ø 4,0	A55	640355
<b>GÜDE</b>							
KS 400E	40	3/8"	57	1,3	ø 4,0	A57	640357
<b>HANDY</b>							
30HF, E 140F	30	3/8"	44	1,3	ø 4,0	A44	640344
35 HF	35	3/8"	49	1,3	ø 4,0	A49	640349

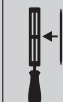



# Zaagkettingen gesorteerd volgens fabrikant

Fabrikant/machinetype	Zwaardlengte cm	Steek 	Aandrijf- schakels 	Aandrijf- schakeldikte 		kwb- code	Art.-nr.
<b>HANSEATIC</b>							
1840 KS, 2040 KS	40	3/8"	57	1,3	ø 4,0	A57	640357
<b>HERKULES</b>							
18/41	40	3/8"	57	1,3	ø 4,0	A57	640357
41/41	40	3/8"	56	1,3	ø 4,0	A56	640356
<b>HITACHI</b>							
CS 280A, CS 280B	30	3/8"	45	1,3	ø 4,0	A45	640345
CS 350A, CS 350B	35	3/8"	52	1,3	ø 4,0	A52	640352
CS 35B	40	3/8"	57	1,3	ø 4,0	A57	640357
<b>HOMELITE</b>							
i335, i3350B, D 3850B, D 3850BC, 23AV, Sabre S 3350B, S 1035	30	3/8"	45	1,3	ø 4,0	A45	640345
i335, i3350B, D 3850B, D 3850BC, 23AV, Sabre S 3350B, S 1035, HCS 3435BA, CSP 3314, Bandit BSC 35, BanditXLX30, ECW 1636, HCS 3335, XL2 Super, XL, XEL, XLTI, 240SL	35	3/8"	52	1,3	ø 4,0	A52	640352
2014B, 20AV, HCS 3435BA, ECW 1641	40	3/8"	56	1,3	ø 4,0	A56	640356
CSP 4016	40	3/8"	57	1,3	ø 4,0	A57	640357
i3850B, D 4550B, D 3850BC, EZ-AO-130/150/290/340, XL-76/100/250, VI-123/125, VISuper Mini	38	.325	64	1,3	ø 4,8	D64	640864
<b>HURRICANE</b>							
MKS 38/35	35	3/8"	49	1,3	ø 4,0	A49	640349
HEK 18-35	35	3/8"	52	1,3	ø 4,0	A52	640352
ES 2040S	40	3/8"	55	1,3	ø 4,0	A55	640355
PS 200-40E	40	3/8"	57	1,3	ø 4,0	A57	640357
<b>HUSQUARNA</b>							
Husky 33, Husky 34	30	3/8"	45	1,3	ø 4,0	A45	640345
Husky 35, Hisky 36, 315, 316, 318, 320 Electric	35	3/8"	52	1,3	ø 4,0	A52	640352
Husky 32, Husky 38	35	3/8"	53	1,3	ø 4,0	A53	640353
Husky 35, Hisky 36, Husky 37, Husky 41, 315, 316, 318, 320 Electric	40	3/8"	56	1,3	ø 4,0	A56	640356
33, 36, 40, 41, 42, 44, 45, 49, 51, 55, 131, 136, 141, EL1200, E1400, E1600, EL16, 136, 137 e-serie, 140, 141, 142 e-serie, 340, 345, 346, 350, 351, 242XP	38	.325	64	1,3	ø 4,8	D64	640864
<b>HUSQUARNA</b>							
61, 75, 77, 162, 163, 181, 246, 262, 263, 266, 268, 272, 280, 281, 285, 286, 288, 289, 298, 365, 371, 380, 480 (XP/XPG), 61, 65, 66, 1100, 2100, 2100XP, 2101, 25XP, 245XPG, 254XP, 254XPG, 27, 262, 264, 288XPG, 338XPT, 334T, 365, 372XP, 385XP, 394XPG, 395XP, 395XPG, 3120XP, 55	38	3/8"	56	1,5	ø 4,8	L56	641756
<b>IKRA</b>							
MKS 30	30	3/8"	44	1,3	ø 4,0	A44	640344
KS30ST, KS400, KS12A, A104P PowerSharp, A104A	30	3/8"	45	1,3	ø 4,0	A45	640345
A104P+S, A204S, A205B, FA12, FA14, KS12, H014S, KS14, KS30ST, KS400, KS1200B, KS1250B, KS1300, Shark1300, KS1400, KS1400A, KS1400B, KS1500, KS1600, KS2000, 1200KS, Shark PE1400, Sup-Pro 1500, KS1500T, KS 1500TS, KS1700DL, KSE2000, EKS30, EKS35, EKS40, EKS1500-35, EKS1400, EKS1600, EKS1650, EKS1700, EKS1800, EKS2000, BKS301, BKS402, BKS4135, PKS40	30	3/8"	45	1,3	ø 4,0	A45	640345
	35	3/8"	52	1,3	ø 4,0	A52	640352
	40	3/8"	56	1,3	ø 4,0	A56	640356
	40	3/8"	57	1,3	ø 4,0	A57	640357
KS14A, H014A, A104P PowerSharp	35	3/8"	52	1,3	ø 4,0	A52	640352
KSI1600-35, KSI1600-40, KSI1800-40, KSE2000-35, KSE2000-40, KSE2000-45, KS1500TS	35	3/8"	52	1,3	ø 4,0	A52	640352
	40	3/8"	57	1,3	ø 4,0	A57	640357
	35	3/8"	52	1,3	ø 4,0	A52	640352
BKS4141	40	3/8"	56	1,3	ø 4,0	A56	640356
	35	3/8"	52	1,3	ø 4,0	A52	640352
KS1400T, KS1500T	40	3/8"	57	1,3	ø 4,0	A57	640357
KS1600T	40	3/8"	57	1,3	ø 4,0	A57	640357
CMI 1735BKS, BKS 35-14, KS 1938/35	35	3/8"	49	1,3	ø 4,0	A49	640349

Fabrikant/machinetype	Zwaardlengte cm	Steek 	Aandrijf- schakels 	Aandrijf- schakeldikte 		kwb- code	Art.-nr.
<b>IKRA</b>							
MKS 35, KS1300Shark	35	3/8"	50	1,3	ø 4,0	A50	640350
EL1400, Hobby Cutter, KS1200B, KS1250, KS1400A, KS1400T, KS1400TF, KS1435, KS1600T-35, KS1600TF-35, KS1600TS-35, KS14A, A104P PowerSharp	35	3/8"	52	1,3	ø 4,0	A52	640352
BKS 38-16	40	3/8"	55	1,3	ø 4,0	A55	640355
KS1400B-40, KS1500B-40, KSB3940, MKS 40, Peifi Cutter, SEK 618	40	3/8"	56	1,3	ø 4,0	A56	640356
KS1640, BKS401, KSI2000-40, SWING1840KS, 2140KSE, Variolux, SWING2040KS, CMI2040S, Hanseatic 1840KSM, KSE2040, KS1600T-40, KS2000TF, KS2000TS, KS1600TF-40, 1640Shark, KF1800TF-40, KF1800TS-40, KS1400T/TS, KS1640, KS1800TF/TS, PKS40, KS2000TF/TS	40	3/8"	57	1,3	ø 4,0	A57	640357
<b>JONSERED</b>							
2033, 370, 380, CS2115EL, CS2120EL, CS2137	30	3/8"	45	1,3	ø 4,0	A45	640345
2036, 2040, 2033, 370, 380, CS2115EL, CS2120EL, CS2137	35	3/8"	52	1,3	ø 4,0	A52	640352
2036, 2040, 2033, 370, 380, CS2115EL, CS2120EL, CS2137	40	3/8"	56	1,3	ø 4,0	A56	640356
2016, 2036, 2040, 2041, 2045, 2050, 2054, 2055, CS2147, CS2152	38	.325	64	1,3	ø 4,8	D64	640864
CS2156, CS2159, CS2163, CS2165, CS2171	38	3/8"	56	1,5	ø 4,8	L56	641756
<b>KINGCRAFT</b>							
KS1500B	40	3/8"	56	1,3	ø 4,0	A56	640356
EKS1650, KSI2000-40	40	3/8"	57	1,3	ø 4,0	A57	640357
<b>KOMATSU ZENOAH</b>							
G31AVS, G310TS, G3100, G3200, G3300, G380AVS, G3800, G2800AVS	30	3/8"	45	1,3	ø 4,0	A45	640345
	35	3/8"	52	1,3	ø 4,0	A52	640352
	40	3/8"	57	1,3	ø 4,0	A57	640357
<b>LIDL</b>							
KSE1435, 1640, PKS 2000/4	40	3/8"	55	1,3	ø 4,0	A55	640355
<b>MAKITA</b>							
EL-UC 210R, DCS 34, UC 3010A, UC 3510U, DCS3400, DCS 3410, UC 4010A	35	3/8"	52	1,1	ø 4,0	C52	640652
SDK 100	30	3/8"	45	1,3	ø 4,0	A45	640345
Electric 5011B, Electric 5012B, Electric, 5014-NB, Electric 5016-B, Electric 5016-NB	30	3/8"	45	1,3	ø 4,0	A45	640345
	35	3/8"	52	1,3	ø 4,0	A52	640352
	40	3/8"	57	1,3	ø 4,0	A57	640357
DCS 33, DCS 34, DCS 300, DCS 330, DCS 330S, DCS 330TH, DCS 340, DCS 341, DCS 342, DCS 344, DCS 350, DCS 380, DCS 390, DCS 400, DCS 401, DCS 3300TH, DCS 3400TH, DCS 3401TH, DCS 3500, DCS 3501, DCS 4610, DES 350, DES 400, UC 300, UC 3000, UC 3000A, UC 3001A, UC 3003A, UC 3500, UC 3500A, UC 3501A, UC 3503A, UC 4000, UC 4000A, UC 4001A, UC 4003A, 5014B, 5016B, 5016NB	30	3/8"	46	1,3	ø 4,0	A46	640346
	35	3/8"	52	1,3	ø 4,0	A52	640352
	40	3/8"	56	1,3	ø 4,0	A56	640356
	40	3/8"	57	1,3	ø 4,0	A57	640357
ES 2000-400, EK 2000-400	40	3/8"	57	1,3	ø 4,0	A57	640357
DCS 410, DCS 411, DCS 4301, DCS 440, DCS 441, DCS 430, DCS 520, DCS 4300i, DCS 5200i	38	.325	64	1,3	ø 4,8	D64	640864
DCS 43, DCS 52, DCS 430, DCS 431, DCS 460, DCS 461, DCS 480, DCS 500, DCS 501, DCS 520, DCS 520i, DCS 4300, DCS 4600S, DCS 4600SH, DCS 5000, DCS 5001, DCS 5000H, DCS 5200i, DCS 6600, DCS 6000i, DCS 6400, DCS 6800, DCS 6800i, DCS 7300, DCS 7900	38	3/8"	56	1,5	ø 4,8	L56	641756
<b>MAFELL</b>							
EKS400S	38	.325	64	1,3	ø 4,8	D64	640864
<b>MATRIX</b>							
ES2000-400, EK2000-400	40	3/8"	57	1,3	ø 4,0	A57	640357
<b>MAX BAHR</b>							
Bahr 2000, Bonus 1800, EKS 1800-40, KSI 2000-40	40	3/8"	57	1,3	ø 4,0	A57	640357





# Zaagkettingen gesorteerd volgens fabrikant





Fabrikant/machinetype	Zwaardlengte cm	Steek 	Aandrijf- schakels 	Aandrijf- schakeldikte 		kwb- code	Art.-nr.
<b>MCCULLOCH</b>							
Electramac 230/1030, 230, 312, 312s, 330, 1030, ES22, S12, Mac 930/12, Euromac 30/E30/ES30, Euromac S12, PM 360/364/730/930	30	3/8"	45	1,3	ø 4,0	A45	640345
E14, Electramac14E, ES80, 230, 1030, S22, ES30, Euromac35, 833, S12, S33, S34, Mac12, 130, 140, 833, 835, 836, Mini Mac30, Mini Mac833, PM730, Titan7	35	3/8"	49	1,3	ø 4,0	A49	640349
Electramac235, 1035, 35, Euromac530, S14, Mac Cut, Mac 538, 538a, 538e, 540, 545, 545e, 546, California, California 2000/Kit, 930,935, PM36, 370, 374, 470, 474, 486, 735, Titan35, PM 1-10, 2-10, 3-10, 4-10, 5-10, 6-10, 7-10, 10-10, 55, PM60, 70, 80, 81, 555, PM570, 610, 650, 655, PM700, 800, 805, 850, PM1000, DE-50, SP-60, Titan 50, 57	35	3/8"	50	1,3	ø 4,0	A50	640350
Mac 335, 435, MacCat 438	35	3/8"	52	1,3	ø 4,0	A52	640352
Electramac 240, 316, 316a, 340E, 1040, ES28, S16, Mac 538, 538e, 539e, 540, 540e, 545, 545e, 546, 838, 940, Mac Cat 839, California, California 2000/Kit, KSB2340, Mac6, Mac6B, Mac740, Mac940, PM486, EM30, Mac12, Mac28, MiniMac832, Titan7	40	3/8"	55	1,3	ø 4,0	A55	640355
MacCat 440, 441, 442	40	3/8"	56	1,3	ø 4,0	A56	640356
Electramac 16-EE, ES 30, 22, 24, 26, 35, 36, 40, PM-394, PM-494, M 1, 2, 2B, 4, 4B, 6, 6B, Californian, Arizona, Eager-Beaver, 10, 12, 12 A/S, 14 AVS, 16 E, 170, 374, 384, 394, 484, 494, 735, 930, 935, C 180, EM-8	30	3/8"	44	1,3	ø 4,0	A44	640344
	35	3/8"	49	1,3	ø 4,0	A49	640349
	35	3/8"	50	1,3	ø 4,0	A50	640350
	40	3/8"	55	1,3	ø 4,0	A55	640355
40	3/8"	56	1,3	ø 4,0	A56	640356	
PM 1-10, 2-10, 3-10, 4-10, 5-10, 6-10, 7-10, 10-10, 55, PM60, 70, 80, 81, 555, PM570, 610, 650, 655, PM700, 800, 805, 850, PM1000, DE-50, SP-60, Titan 50, 57	35	3/8"	50	1,3	ø 4,0	A50	640350
Mac110, 120, 130, 140, 160, PM300, PM310, PM320, PM330, PM340, PM360, PM364, PM370, PM380, PM394, PM470, PM474, PM480, PM484, PM494, PM530, PM538, PM540, 832, 833, 835, 836, 838, 839, 930, Euromac S32, S33, S34, S36, S40, S41, ELECTR	30	3/8"	44	1,3	ø 4,0	A44	640344
	35	3/8"	49	1,3	ø 4,0	A49	640349
	40	3/8"	55	1,3	ø 4,0	A55	640355
PM 3500, 4000, 400-P, 4500, 4700, 4900, 5000, Titan 35+40, Logger-Kit, 3500, 400P, T 35, T 40, PM 38, 40-46, T 46, T 48, ProMac 10-42, ProMac 10-49Pro, ProMac 40, ProMac 40II, ProMac 46, ProMac 46II, Timber	38	.325	64	1,3	ø 4,8	D64	640864
Mac 950, 951, 955, 960, 961, 970, Pro Mac 51, 55, 60, 61, 72, Titan 51, 61, Topso	38	3/8"	56	1,5	ø 4,8	L56	641756
<b>METABO</b>							
5338 B	30	3/8"	44	1,3	ø 4,0	A44	640344
KT 1441, KT1440	40	3/8"	57	1,3	ø 4,0	A57	640357
<b>NAUTEC</b>							
131	35	3/8"	52	1,3	ø 4,0	A52	640352
138	38	.325	64	1,3	ø 4,8	D64	640864
<b>OBI-CMI</b>							
CMI 1735BKS, 2115, EKS 1800-35	35	3/8"	52	1,3	ø 4,0	A52	640352
CMI 2040KS/KSI, 2040KSS, BKS45, KS 1840/1, KS 2000	40	3/8"	57	1,3	ø 4,0	A57	640357
<b>OBI-DIANA</b>							
1300-35KS	35	3/8"	52	1,3	ø 4,0	A52	640352
1400-40KS	40	3/8"	56	1,3	ø 4,0	A56	640356
<b>O.K.</b>							
EKS 1840	40	3/8"	57	1,3	ø 4,0	A57	640357
<b>OLEO MAC OLYM.</b>							
E 1500	35	3/8"	50	1,1	ø 4,8	C50	640650
937	35	3/8"	52	1,3	ø 4,0	A52	640352
35, 233, 234, 240, 241, 244, 335, 340, 930, 935D, 935X, 935DX, E140F, E160F, E170F, E1700, E170, E1900, E-200	30	3/8"	44	1,3	ø 4,0	A44	640344
	35	3/8"	49	1,3	ø 4,0	A49	640349
	35	3/8"	50	1,3	ø 4,0	A50	640350

Fabrikant/machinetype	Zwaardlengte cm	Steek 	Aandrijf- schakels 	Aandrijf- schakeldikte 		kwb- code	Art.-nr.
<b>OLEO MAC OLYM.</b>							
936, 940C, E140	30	3/8"	44	1,3	ø 4,0	A44	640344
	35	3/8"	49	1,3	ø 4,0	A49	640349
	40	3/8"	56	1,3	ø 4,0	A56	640356
931, 932, 932C	30	3/8"	45	1,3	ø 4,0	A45	640345
	35	3/8"	52	1,3	ø 4,0	A52	640352
935, 936, 940	35	3/8"	52	1,3	ø 4,0	A52	640352
	40	3/8"	57	1,3	ø 4,0	A57	640357
240, E170, E170F	40	.325	64	1,3	ø 4,8	D64	640864
945, 950, 938, 941	38	.325	64	1,3	ø 4,8	D64	640864
250, 250A, 251, 251B, 251S, 252, 254, 260, 261, 264, 271, 272, 280, 284, 350, 350S, 355, 460, 480, 481, 482, 484, E 300, OM-E 300, 956, 962, 970, 980	38	3/8"	56	1,5	ø 4,8	L56	641756
<b>OPEM</b>							
130Z	30	3/8"	45	1,3	ø 4,0	A45	640345
140Z, 142Z	35	3/8"	52	1,3	ø 4,0	A52	640352
	40	3/8"	57	1,3	ø 4,0	A57	640357
<b>PARKSIDE</b>							
KSE1435, KSE1640, EKS1650, 1700PKS40, 2000	40	3/8"	55	1,3	ø 4,0	A55	640355
	40	3/8"	56	1,3	ø 4,0	A56	640356
<b>PARTNER</b>							
1436, 1641	35	3/8"	52	1,1	ø 4,0	C52	640652
1400E, 1500-EL, 1601, 1602, 1612, 1613, 1614, 1616, 1618	30	3/8"	44	1,3	ø 4,0	A44	640344
	30	3/8"	45	1,3	ø 4,0	A45	640345
	35	3/8"	50	1,3	ø 4,0	A50	640350
	40	3/8"	56	1,3	ø 4,0	A56	640356
330, 335, 340, 345, 350, 351, 357, 360, 365, 370, 371, 385, 389, 390, 405, P-420, P 740, P 842, P842CC	30	3/8"	45	1,3	ø 4,0	A45	640345
	35	3/8"	50	1,3	ø 4,0	A50	640350
	35	3/8"	52	1,3	ø 4,0	A52	640352
	40	3/8"	56	1,3	ø 4,0	A56	640356
1601,1602, 1612, 1613, 1614, 1616, 1618, 395, 420, 465	35	3/8"	52	1,3	ø 4,0	A52	640352
341, 395, 420, 1200, 1450	30	3/8"	45	1,3	ø 4,0	A45	640345
341, 395, 420, 1614	35	3/8"	50	1,3	ø 4,0	A50	640350
P1535, P1550, 1640, P1850, P538, 538E	35	3/8"	50	1,3	ø 4,0	A50	640350
	40	3/8"	55	1,3	ø 4,0	A55	640355
P-21, 26, 28, 360, 365, 400, 405, 410, 411, 450, 460, P461, P461II, 462, P470, 500, P510, 511, 540, 543, 1074, 5000, EL 1450, EL 1650	38	.325	64	1,3	ø 4,8	D64	640864
P 500, 605, P 5000	38	3/8"	56	1,5	ø 4,8	L56	641756
550, 650, 660, 1633-B, F 55, F 65, P-55, 65, 70, 85, 7000, R-11, 12, 14, R-16, 17, 18, 19, 20, 21, R-22, 30, 40, 417, 418, R-420, 421,422, 435, R-440, 522, 523, S-50, 55, 65, 660, P-7700	38	3/8"	56	1,5	ø 4,8	L56	641756
<b>PEUGEOT</b>							
TLS 1630, TRC 1630, TLS 1635, TLS 1635A, TRC 1635, TLS 1640, TRC 1640, EKS1740	30	3/8"	45	1,3	ø 4,0	A45	640345
	35	3/8"	50	1,3	ø 4,0	A50	640350
	40	3/8"	56	1,3	ø 4,0	A56	640356
<b>POULAN</b>							
E 5300	35	3/8"	52	1,3	ø 4,0	C52	640652
Micro 25, Micro 25A	30	3/8"	45	1,3	ø 4,0	A45	640345
25A, S 25D, S 25DA, 1400E, 2000, 2300AV, 2300CVA, P 600, 2050, 2150, 2250, 2450, 2550, Woodshark, Pro4016	35	3/8"	52	1,3	ø 4,0	A52	640352
2050, 2150, 2250, 2450, 2550, Woodshark, Pro4016	40	3/8"	56	1,3	ø 4,0	A56	640356
25A, Micro 25, S 25 CVA, S 25D, S 25DA, 1800, 2000, 2300AV, 2300CVA, P 600	40	3/8"	57	1,3	ø 4,0	A57	640357
2800, 2900, 3300, 3350	38	.325	64	1,3	ø 4,8	D64	640864
<b>PROVIL</b>							
PVKS 20000E, PVKS 2000/1E	40	3/8"	57	1,3	ø 4,0	A57	640357



# Zaagkettingen gesorteerd volgens fabrikant

Fabrikant/machinetype	Zwaardlengte cm	Steek 	Aandrijf- schakels 	Aandrijf- schakeldikte 		kwb- code	Art.-nr.
<b>REMINGTON</b>							
860 AV, Cutter, EL6 DELUXE	30	3/8"	45	1,3	ø 4,0	A45	640345
Mighty Mite 500/812/814	35	3/8"	49	1,3	ø 4,0	A49	640349
Electricpower, Limb`n`-Trim, 1450	35	3/8"	50	1,3	ø 4,0	A50	640350
<b>RYOBI</b>							
35B, CS 36C, CS 41, CSE 330, CSE 3330, CSE 385CB, HC 31, HCS 31, HC 36, HC 41, CS 1530, CS 1535, CS 1540	30	3/8"	44	1,3	ø 4,0	A44	640344
	35	3/8"	49	1,3	ø 4,0	A49	640349
	40	3/8"	55	1,3	ø 4,0	A55	640355
CS 290, C 300, CS1530	30	3/8"	44	1,3	ø 4,0	A44	640344
CSE 385CB, HC 36, CS 360, CS1535	35	3/8"	49	1,3	ø 4,0	A49	640349
CSP 3314, ECW 1636, PCN 3335, RCS 3335	35	3/8"	52	1,3	ø 4,0	A52	640352
CS 41, HC 41, CS1540	40	3/8"	55	1,3	ø 4,0	A55	640355
HCS 3435BA	40	3/8"	57	1,3	ø 4,0	A57	640357
CSN 410, ECW 1641, HCS 340BA	40	3/8"	56	1,3	ø 4,0	A56	640356
<b>SABRE</b>							
S 3350B, 1035, CS 35, BCS 35	35	3/8"	52	1,3	ø 4,0	A52	640352
<b>SHARK</b>							
1300-35	35	3/8"	50	1,3	ø 4,0	A50	640350
BKS3540	35	3/8"	49	1,3	ø 4,0	A49	640349
<b>SHINDAIWA-SDK-ISEKI</b>							
SBA-P230	30	3/8"	50	1,1	ø 4,0	C44	640644
140, 160, 285s, 300s, 305s, 305AVZ, 340, 345, 346, 350, 352s, 355, 357, 357s, 360, 377, 391, 395, A-090, 102, 103, 104, 105, 107, 110, 110P, 113L+P, 117P, 100, E 150, 315, YB 301, YB 401, A 090B, A 100C, A 102, A 150B	30	3/8"	45	1,3	ø 4,0	A45	640345
	35	3/8"	52	1,3	ø 4,0	A52	640352
	40	3/8"	57	1,3	ø 4,0	A57	640357
1600 ES	40	3/8"	57	1,3	ø 4,0	A57	640357
360, 366, 370, 394, 400, 415, 416, 420, 450, 451, 457, 488, 495, 500, 506, 510, 560, 601, 691, A-180B, YB 501, YB 601, YB 701	38	.325	64	1,3	ø 4,8	D64	640864
<b>SHINGU</b>							
SP 3200, SP 3200T, SP 3400	35	3/8"	52	1,3	ø 4,0	A52	640352
SP 3400	40	3/8"	57	1,3	ø 4,0	A57	640357
<b>SKIL</b>							
1600HE, 1601HE, 1602HE, 1603H, 1604H, 1606H, 1610U, 1612U, 1616U, 1620U, 1634U, 1636U, 1712U	30	3/8"	45	1,3	ø 4,0	A45	640345
	35	3/8"	52	1,3	ø 4,0	A52	640352
	40	3/8"	57	1,3	ø 4,0	A57	640357
<b>SOLO</b>							
633, 636-Microlite	35	3/8"	52	1,1	ø 4,0	C52	640652
	30	3/8"	45	1,3	ø 4,0	A45	640345
613, 614, 620, 630, 633, 635, 635ECO, 636, 637, 640, 643	35	3/8"	52	1,3	ø 4,0	A52	640352
	40	3/8"	57	1,3	ø 4,0	A57	640357
634, E-105, KSB 2035	35	3/8"	50	1,3	ø 4,0	A50	640350
662, KSB 2640	40	3/8"	56	1,3	ø 4,0	A56	640356
662, 670, 680, 690	38	3/8"	56	1,5	ø 4,8	L56	641756
634, 639, 645	38	.325	64	1,3	ø 4,8	D64	640864
<b>STARK-SYMPRA-SYMPRATEC</b>							
1400, 1412, 1430, 14830	30	3/8"	44	1,3	ø 4,0	A44	640344
1414, 1435, 14350, 14835	35	3/8"	49	1,3	ø 4,0	A49	640349
1416, 1500, 1600, 1616, 1440, 14840, 16840	40	3/8"	55	1,3	ø 4,0	A55	640355
<b>STAYER</b>							
SEC 40	40	3/8"	56	1,3	ø 4,0	A56	640356
<b>STEINMAX</b>							
CS 300	30	3/8"	44	1,3	ø 4,0	A44	640344
CS 360	35	3/8"	49	1,3	ø 4,0	A49	640349

Fabrikant/machinetype	Zwaardlengte cm	Steek 	Aandrijf- schakels 	Aandrijf- schakeldikte 		kwb- code	Art.-nr.
<b>STIGA</b>							
SP 340	30	3/8"	44	1,3	ø 4,0	A44	640344
930	30	3/8"	45	1,3	ø 4,0	A45	640345
935, SP 340, SE 1.6	35	3/8"	50	1,3	ø 4,0	A50	640350
SE 1.8, SE180, SE 190, SE 200Q, SP 370, SP 410,	35	3/8"	50	1,3	ø 4,0	A50	640350
SPR 350	40	3/8"	56	1,3	ø 4,0	A56	640356
SP 410, SP 370	38	.325	64	1,3	ø 4,8	D64	640864
<b>STIHL</b>							
009, 017, 018, 019/T, 23L, E 140, MS 170, MS 171C, MS 180,	30	3/8"	44	1,1	ø 4,0	C44	640644
MS 181, MS 190T, MS 192, MS 192T, E14, MSE 140, HT 70/75	35	3/8"	50	1,1	ø 4,8	C50	640650
009, 010, 011, 012, 015, 018C, 019, 020, 020/T, 021, 023,	30	3/8"	44	1,3	ø 4,0	A44	640344
023C, 023L, 025, 025C, E 10, E 14, E 20, E 140, E 160, E 180,	35	3/8"	50	1,3	ø 4,0	A50	640350
E 180C, E 220, E 220C, MS 180C, MS 190, MS 190T, MS 200,	40	3/8"	55	1,3	ø 4,0	A55	640355
MS 200T, MS 210, MS 211, MS 230, MS 250, MSE 160,							
MSE 180, MSE 200, AVH-Elektronic							
024/WB, 025, 026/C/W/CW/WB/WVH, 028,	38	.325	62	1,6	ø 4,8	G62	641262
028/S/WB/AV/EQ, MS 240, MS 260, MS 270, MS 280							
029, 030, 031, 032, 034/S, 036/W/WVH, 036QS, 038, 039, 041,	40	3/8"	60	1,6	ø 4,8	M60	641860
042, 044, 045, 046, 048, 056, 064, E-10, E-16, E-20, E-220, MS 290							
MS 310, MS 360/C, MS 390, MS 440/C, MS 460/C, MS 660							
<b>SWING</b>							
1840KS, 2040KS	40	3/8"	57	1,3	ø 4,0	A57	640357
<b>TALON</b>							
	30	3/8"	45	1,3	ø 4,0	A45	640345
	35	3/8"	49	1,3	ø 4,0	A49	640349
AC2101, AC2105, AC2109, AC2111, AC3100	35	3/8"	52	1,3	ø 4,0	A52	640352
	40	3/8"	55	1,3	ø 4,0	A55	640355
	40	3/8"	56	1,3	ø 4,0	A56	640356
<b>TAS-TANAKA</b>							
TPS 2501, TPS 2501S, TPS 2510, RPS 200H	30	3/8"	44	1,1	ø 4,0	C44	640644
	30	3/8"	45	1,3	ø 4,0	A45	640345
290, 300, ECS 320, ECS 330, ECS 3301, ECS 3351, ECS 3401,	35	3/8"	52	1,3	ø 4,0	A52	640352
TCS 3301S, TCS 3401	40	3/8"	57	1,3	ø 4,0	A57	640357
<b>TECHNIC TOOL</b>							
PP 1250	30	3/8"	44	1,3	ø 4,0	A44	640344
<b>TOPCRAFT</b>							
KSI2000-40, EKS1700, EKS1750, EKS1800	40	3/8"	56	1,3	ø 4,0	A56	640356
	40	3/8"	57	1,3	ø 4,0	A57	640357
<b>TURBO SILENT</b>							
BKS3536	35	3/8"	52	1,3	ø 4,0	A52	640352
BKS4041	40	3/8"	56	1,3	ø 4,0	A56	640356
EKS2040	40	3/8"	57	1,3	ø 4,0	A57	640357
<b>UNIROPA</b>							
BKS3840	35	3/8"	49	1,3	ø 4,0	A49	640349
	35	3/8"	52	1,3	ø 4,0	A52	640352
KSE2035, KSI1800-35, KSE2040, KSI20-40	40	3/8"	57	1,3	ø 4,0	A57	640357
<b>VARIOLUX</b>							
2135KSE, 2140KSE, 2335BK, 2340BK	35	3/8"	52	1,3	ø 4,0	A52	640352
	40	3/8"	57	1,3	ø 4,0	A57	640357
<b>ZENOA H</b>							
G 300T, G 300AVS	30	3/8"	46	1,3	ø 4,0	A46	640346
G 310TS, G 320AV, G 320AVS, G 3100, G 3200	35	3/8"	52	1,3	ø 4,0	A52	640352
G 380AV, G 380AVS, G 3800AVS	40	3/8"	57	1,3	ø 4,0	A57	640357
G 415AVS-16	38	.325	64	1,3	ø 4,8	D64	640864



# NYLON DRAAD

... altijd de passende toebehoren voor uw machine!



## Nylon draad



### Nylon draad voor grastrimmers

De nylon draad is bijzonder geschikt voor het snijden van zacht gras en dunne ondergroei met normale grastrimmers.

### Professionele nylon draad voor bosmaaiers

De extra sterke nylon draad voor professioneel gebruik is bijzonder geschikt voor het snijden van hard gras en harde ondergroei met normale bosmaaiers.

## Programma overzicht nylon draad

### Nylon draad



Nylon draad, wit, voor gras en zachte ondergroei, voor normaal verkrijgbare bosmaaiers (graskantrimmers).

Art.-nr.	Ø mm	Lengte			EAN
654113	Draad Ø mm 1,3	15 m		1	4 009316 541135
654116	Draad Ø mm 1,6	15 m		1	4 009316 541166
654120	Draad Ø mm 2,0	15 m		1	4 009316 541203
654124	Draad Ø mm 2,4	15 m		1	4 009316 541241



### Nylon draad PROFESSIONEEL



Nylon draad PROFESSIONEEL, geel, extra sterk, voor gras en harde ondergroei, voor een professioneel continu gebruik, voor normaal verkrijgbare bosmaaiers.

Art.-nr.	Ø mm	Lengte			EAN
654213	Draad Ø mm 1,3	15 m		1	4 009316 542132
654216	Draad Ø mm 1,6	15 m		1	4 009316 542163
654220	Draad Ø mm 2,0	15 m		1	4 009316 542200
654224	Draad Ø mm 2,4	15 m		1	4 009316 542248



... altijd de passende toebehoren voor uw machine!





**TACKERS  
NIETEN  
HETELIJMPISTOLEN**

## Tackers, nieten, nagels



### Tackers

- Professionele elektrische tacker van de serie TT
- Professionele industriële handtacker van de serie MT
- Professionele handtacker van de serie PT
- Professionele hamertacker van de serie HAT

### Bevestigingsmiddelen voor hand- en elektrische tackers

De passende bevestigingsmiddelen vindt u in de tabel op de pagina's 319 - 325

## Programma overzicht



### Professionele elektrische tacker TT ★★★★★

Voor het verwerken van nieten, nagels en stiften, extra hoge slagkracht, met veiligheidshendel tegen onbedoeld activeren, ideaal voor de dakbouw en voor het verwerken van profielplanken.

Pagina 314



### Professionele hamertacker HT ★★★★★

De hamertacker wordt zoals een hamer ingezet: door snel slaan worden de nieten in het werkstuk geslagen, ideaal voor de snelle verwerking van nieten in de dakbouw.

Pagina 314



### Industriële handtacker MT ★★★★★

Met metalen behuizing, voor het verwerken van nieten, nagels en stiften, ideaal voor gebruik in werkplaats, huis en tuin.

Pagina 315



### Professionele handtacker PT ★★★★★

Met behuizing van glasvezelversterkte kunststof, voor het verwerken van nieten, spijkers en pennen, ideaal voor gebruik in werkplaats, huis en tuin.

Pagina 315



## Toepassingsgebieden voor tackernieten

### Fijne draad

Het universele bevestigingsmiddel voor vele toepassingen. Bruikbaar voor papier, karton, textiel, kussens, draadwerk, hobby, knutselwerken, dunne houten lijsten.

### Fijne draad, roestvrij (Monel)

Voor alle buitentoepassingen waarbij niets mag roesten. Bruikbaar voor papier, karton, textiel, draadwerk, was- en oliepapier, etiketten, kussens in de scheepsbouw.

### Nagels

Een nagel voor vele toepassingen voor vakmannen en doe-het-zelvers. Geschikt voor eenvoudige bevestigingen met aan te brengen materiaal, zoals bijv. lijsten, sierlijsten, hoeklijsten, plinten, profielhout, panelen of voor de bouw van kisten.

### Platte draad

Bevestigingsmiddel voor speciale, dunne materialen. Bruikbaar voor papier, karton, textiel, kussens, draadwerk, hobby, knutselwerken, dakvilt, folies, dakbouw, spijkerflensdekens, aluminium cacheringen, kurkplaten, was- en oliepapier, etiketten. Niet met D-punt zijn bijzonder geschikt voor profielhoutklemmen voor de lambrisering van wanden en plafonds.

### Smalle rug

Diep indringend bevestigingsmiddel met bijzonder vaste zitting bij weinig opvallende nietruggen. Bruikbaar voor profielhout, panelen, houtvezelplaten, draadwerk, multiplex.

## Hetelijmpistolen



### Hetelijmpistolen ★★★★★

Door de mechanische aanvoer wordt de lijmstick met verhitting aan de lijmmond tot smelten gebracht. Door de lijm puntsgewijs of op kleine oppervlakken aan te brengen, worden de werkstukken verbonden, terwijl de lijm nog heet en vloeibaar is. Door het afkoelen hardt de lijm uit en houdt hij de werkstukken samen.

Pagina 326

## Hetelijmpistolen

- Voor snelle en duurzame lijmverbindingen bij het knutselen, repareren en decoreren
- Alleslijm voor huis, werkplaats en hobby
- Heel nauwkeurig lijmen van metalen, glas, keramiek, marmer, hout, leer, textiel en kunststof
- Weerbestendige lijm



### Lijmpatronen ★★★★★

Lijmpatronen met Ø 7 mm en Ø 11 mm, in lengten van 100 mm en 200 mm. Voor het vastplakken van de meest uiteenlopende materialen. Passend voor standaard hetelijmpistolen.

Ideaal voor gebruik bij het knutselen of voor kleine reparaties in huis en werkplaats.

Pagina 327

**Elektrische tacker TACKERTRONIX<sup>®</sup> TT 26**



Elektrische tacker TACKERTRONIX<sup>®</sup> TT 26, professioneel apparaat in aluminiumkoffer, extra hoge slagkracht, veiligheidshendel tegen onopzettelijk in werking stellen, 220V/50/60Hz-wisselstroom, dubbel geïsoleerd, met radiostoringsonderdrukking, slagfrequentie 20/min, voor nieten van het type 055 tot 26 mm en spijkers van het type 055 tot 25 mm.

Art.-nr.	Voor klemmen	Voor stiften / nagels			EAN
532600	Type 055 / 12-26mm	Type 055 / 16-25 mm		1	4 009315 326009

**Elektrische tacker TACKERTRONIX<sup>®</sup> TT 18**



Elektrische tacker TACKERTRONIX<sup>®</sup> TT 18, professioneel apparaat in aluminiumkoffer, extra hoge slagkracht, veiligheidshendel tegen onopzettelijk in werking stellen, 220V/50/60Hz-wisselstroom, dubbel geïsoleerd, met radiostoringsonderdrukking, slagfrequentie 20/min, voor nieten van het type 053 tot 20 mm en spijkers van het type 055 tot 19 mm.

Art.-nr.	Voor klemmen	Voor stiften / nagels			EAN
531800	Type 053 / 8-20 mm	Type 055 / 16+19 mm		1	4 009315 318004

**Elektrische tacker TACKERTRONIX<sup>®</sup> TT 14**



Elektrische tacker TACKERTRONIX<sup>®</sup> TT 14, extra hoge slagkracht, veiligheidshendel tegen onopzettelijk in werking stellen, 220V/50/60Hz-wisselstroom, dubbel geïsoleerd, met radiostoringsonderdrukking, slagfrequentie 20/min, voor nieten van het type 053 tot 14 mm en spijkers van het type 055 tot 16 mm.

Art.-nr.	Voor klemmen	Voor stiften / nagels			EAN
531400	Type 053 / 6-14 mm	Type 055 / 16 mm		1	4 009315 314006

**PROFESSIONELE hamertacker HT 057**



PROFESSIONELE hamertacker HT 057, handgreep met vingerbescherming, magazijn voor maximaal 160 nieten, met reservestootmessen, voor nieten van het type 057 tot 10 mm.

Art.-nr.	Voor klemmen			EAN
057057	Typ 057 / 6-10mm		1	4 009310 570575

**Hamertacker HT 053**



Hamertacker HT 053, handgreep met vingerbescherming, magazijn voor maximaal 200 nieten, voor nieten van het type 053 tot 8 mm.

Art.-nr.	Voor klemmen			EAN
053053	Type 053 / 4-8 mm		1	4 009310 530531

## PROFI TACK MT 16 N, industriële handtacker



PROFI TACK MT 16 N, industriële handtacker, zware metalen uitvoering, traploze slagkrachtregeling, voor professioneel continu gebruik, softe handgreep, voor nieten van het type 053 tot 16 mm en pennen en spijkers van het type 055 tot 16 mm.

Art.-nr.	Voor klemmen	Voor stiften / nagels			EAN
053416	Type 053 / 4-16 mm	Type 055 / 16 mm		1	4 009310 534164



## PROFI TACK MT 10, industriële handtacker



PROFI TACK MT 10, industriële handtacker, zware metalen uitvoering, traploze slagkrachtregeling, voor professioneel continu gebruik, voor nieten van het type 053 tot 16 mm en nieten van het type 059 tot 16 mm.

Art.-nr.	Voor klemmen			EAN
053410	Typ 053 / 6-10 mm und Type 059 / 6-10mm		1	4 009310 534102



## BLUE TACK PT 14 N, professionele handtacker



BLUE TACK PT 14 N, professionele handtacker, kunststof uitvoering, glasvezelversterkt met slagkrachtregeling, softe handgreep met antislip, voor nieten type 053 tot 14 mm, pennen en spijkers type 055 tot 16 mm.

Art.-nr.	Voor klemmen	Voor stiften / nagels			EAN
053314	Type 053 / 6-14 mm	Type 055 / 16 mm		1	4 009310 533143



## BLUE TACK PT 10, professionele handtacker



BLUE TACK PT 10, professionele handtacker, kunststof uitvoering, glasvezelversterkt met slagkrachtregeling, softe handgreep met antislip, voor nieten type 053 tot 10 mm.

Art.-nr.	Voor klemmen			EAN
053310	Type 053 / 4-10 mm		1	4 009310 533105



## BLUE TACK PT 8, professionele handtacker



BLUE TACK PT 8, professionele handtacker, kunststof uitvoering, glasvezelversterkt met slagkrachtregeling, softe handgreep met antislip, voor nieten type 053 tot 8 mm.

Art.-nr.	Voor klemmen			EAN
053308	Type 053 / 4-8 mm		1	4 009310 533082



**Nieten, 12,3 mm breed, platte draad, staal**



Kwaliteitsstaaldraad, hoge trekvastheid, bruikbaar voor knutselen, hobby, papier, karton, bekledingswerkzaamheden.

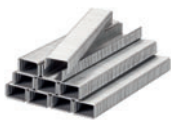

Art.-nr.	Inhoud	Niethoogte			EAN
<b>Type 053/353, fijne draad, staal, C-punt</b>					
352106	1.400	6		5	4 009313 521062
352108	1.000	8		5	4 009313 521086
352110	900	10		5	4 009313 521109
352112	750	12		5	4 009313 521123
352114	600	14 (D-Spitze)		5	4 009313 521147

**Nieten, 11,4 mm breed, fijne draad, standaard**



Kwaliteitsstaaldraad, hoge trekvastheid, bruikbaar voor knutselen, hobby, papier, karton, bekledingswerkzaamheden, textiel, draadwerk.



Art.-nr.	Inhoud	Niethoogte			EAN
<b>Type 053/353, fijne draad, STANDAARD, C-punt</b>					
353004	2.000	4		5	4 009313 530040
353006	1.800	6		5	4 009313 530064
353008	1.400	8		5	4 009313 530088

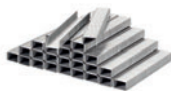

Art.-nr.	Inhoud	Niethoogte			EAN
<b>Type 053/353, fijne draad, STANDAARD, C-punt</b>					
053040	5000	4		1	4 009310 530401
053060	5000	6		1	4 009310 530609
053080	5000	8		1	4 009310 530807

**Nieten, 11,4 mm breed, fijne draad, staal**



Kwaliteitsstaaldraad, hoge trekvastheid, bruikbaar voor knutselen, hobby, papier, karton, bekledingswerkzaamheden, textiel, draadwerk, dunne houten lijsten.

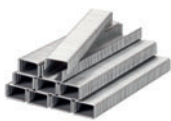

Art.-nr.	Inhoud	Niethoogte			EAN
<b>Type 053/353, fijne draad, staal, C-punt</b>					
353106	1.800	6		5	4 009313 531061
353108	1.400	8		5	4 009313 531085
353110	1.200	10		5	4 009313 531108
353112	1.200	12		5	4 009313 531122
353114	1.000	14		5	4 009313 531146
353116	800	16		5	4 009313 531160
353120	600	20		5	4 009313 531207

## Nieten, 11,4 mm breed, fijne draad, staal



Art.-nr.	Inhoud	Niethoogte			EAN
<b>Type 053/353, fijne draad, staal, C-punt</b>					
053061	5000	6		1	4 009310 530616
053081	5000	8		1	4 009310 530814
053101	5000	10		1	4 009310 531019
053121	5000	12		1	4 009310 531217
053141	5000	14		1	4 009310 531415
053181	5000	18		1	4 009310 531811



## Nieten, 11,4 mm breed, fijne draad, rvs, roestvrij (Monel)



Art.-nr.	Inhoud	Niethoogte			EAN
<b>Type 053, fijne draad, staal, roestvrij</b>					
353585	1.400	8		5	4 009313 535854
353605	1.200	10		5	4 009313 536059

Kwaliteitsstaaldraad, hoge trekvastheid, bruikbaar voor scheepsbouw, bekledingswerkzaamheden in scheepsbouw, textiel, draadwerk, dunne houten lijsten.

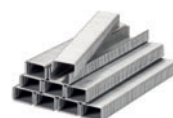

## Nieten, 6,1 mm breed, smalle rug, staal



Art.-nr.	Inhoud	Niethoogte			EAN
<b>Type 055/355, smalle rug, staal, C-punt</b>					
355112	1.200	12		5	4 009313 551120
355115	1.000	15		5	4 009313 551151
355118	800	18		5	4 009313 551182
355123	600	23		5	4 009313 551236
355128	600	28		5	4 009313 551281

Kwaliteitsstaaldraad, hoge trekvastheid, bruikbaar voor profielhout, panelen, houtvezelplaten, multiplex, draadwerk.



## Nieten, 10,7 mm breed, platte draad, staal



Art.-nr.	Inhoud	Niethoogte			EAN
<b>Type 057/357, platte draad, staal, C-punt</b>					
357106	1.400	6		5	4 009313 571067
357108	1.000	8		5	4 009313 571081
357110	900	10		5	4 009313 571104
357112	750	12		5	4 009313 571128
357114	600	14 (D-Spitze)		5	4 009313 571142

Kwaliteitsstaaldraad, hoge trekvastheid, bruikbaar voor papier, karton, labels, dakviit, folie, was- en oliepapier.

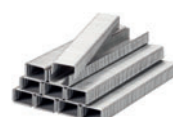

**Nieten, 10,7 mm breed, platte draad, staal**



Art.-nr.	Inhoud	Niethoogte			EAN
<b>Type 057/357, platte draad, staal, C-punt</b>					
057081	5000	8		1	4 009310 570810
057101	5000	10		1	4 009310 571015

**Nieten, 13,0 mm breed, fijne draad, staal**



Kwaliteitsstaaldraad, hoge trekvastheid, bruikbaar voor knutselen, hobby, papier, karton, bekledingswerkzaamheden, houtwerkzaamheden.



Art.-nr.	Inhoud	Niethoogte			EAN
<b>Type 058/358, fijne draad, staal, C-punt</b>					
358108	1.400	8		5	4 009313 581080
358110	1.200	10		5	4 009313 581103

**Nieten, 10,6 mm breed, fijne draad, staal**



Kwaliteitsstaaldraad, hoge trekvastheid, bruikbaar voor knutselen, hobby, papier, karton, bekledingswerkzaamheden, houtwerkzaamheden.



Art.-nr.	Inhoud	Niethoogte			EAN
<b>Type 059/359, fijne draad, staal, C-punt</b>					
359106	1.800	6		5	4 009313 591065
359108	1.400	8		5	4 009313 591089
359110	1.200	10		5	4 009313 591102
359114	1.000	14		5	4 009313 591140

**Spijkers, kop ca. Ø 2,0 mm, extra sterke draad, staal**



Kwaliteitsstaaldraad, bruikbaar voor lijsten, sierlijsten, hoeklijsten kistenbouw, profielhout, panelen en plinten.



Art.-nr.	Inhoud	Niethoogte			EAN
<b>Type 055/355, extra dikke draad, staal, C-punt</b>					
355716	750	16		5	4 009313 557160
355719	750	19		5	4 009313 557191
355725	500	25		5	4 009313 557252
355728	500	28		5	4 009313 557283
355730	500	30		5	4 009313 557306

		Nieten						Nagels
kwb-type		052	053	055	057	058	059	055
Art.-nr.		352-	353- 053-	355-1 055-5	357-	358- 058-	359-	355-7 055-7
 ↓ mm		6-14	4-20	12-30	6-18	8	6-14	12-30
Fabrikant/machinetype								
<b>AEG</b>								
Powertac 14								
Powertac 16								16
Powertac 18								
Powertac 19				12-18				19
Powertac 30				18-30				16-30
<b>ARROW</b>								
JT 21 M, JT 21 CM, T 27			6-10					
T 30						6-10		
T 32, T 32 M						4-8		
T 50, T50 OC, T 55, T 55C					6-16			
CT 50, ETC 50, ETN 50					6-16			
T 50 PBN,, ETL 50					6-16			16
ETF 50 PBN, 50 BN, X50					6-16			16
ET 200								15-32
HT 30							6-10	
HT 50, HTX 50, HAT 55					8-12			
Powershot 5700, 8000					6-16			16
Powershot 5650			6-16		6-16			16
<b>BLACK &amp; DECKER</b>								
A 5980			6-10					
A 5751			4-8					
A 5752			8-14					
A 5918, A 1818		6-14						
BD 418, DN 418, KX 418 E		6-14						
BD 428, DN 428, KX 428 E				16-30				
Powershot					6-14			16
Powerfix				16-30				
SR 190 E, SR 190 EK				16-30				
<b>BOSCH</b>								
HT 8, HMT 53			4-8					
HT 14			4-14					
HMT 57					6-10			
PTK 3,6 LI			4-10					
PTK 14 E, EDT, PTK 3,6 V			6-14					
PTK 19 E			8-18	12-19				16-19
PTK 23 E			12-19	12-23				23
PTK 28 E			12-18	12-28				23-28
<b>BOSTITCH</b>								
siehe STANLEY								
<b>BUKAMA</b>								
Plattennagler Ro 430				30				
<b>BULLKRAFT</b>								
972/207			8-18					
978/132, 979/910, 980/528			4-14					
<b>CASALS</b>								
GR 14								
<b>EMHARD</b>								
POP 1000			6-8					
POP 2000, POP 3000					6-14			
POP 4000					8-18			
<b>ESCO</b>								
Derby 530, S 530, Decora 530			4-8					
Esco 10, 20, HHT 53056,			4-8					
HT 53051, 53052			4-8					
ET 53031, 53055, AT 53001			6-14					16

		Nieten						Nagels
kwb-type		052	053	055	057	058	059	055
Art.-nr.		352-	353- 053-	355-1 055-5	357-	358- 058-	359-	355-7 055-7
 ↓ mm		6-14	4-20	12-30	6-18	8	6-14	12-30
Fabrikant/machinetype								
<b>ESCO</b>								
HT 53053, 53055			6-14					
Compacta 530, C 530, N 530			4-14					
Esco 30, 40			6-14					
Type 58, 58 N						6-14		
Esco 50, 90			6-14					16
200 Electronic				12-25				16-25
100 Electronic			6-14					16
Rally S 530			6-14					
HHT 11					6-10			
HHT 19							4-6	
DLT 530, DLT 53071			8-18					
DLT 606, DLT 60672				15-30				
Multitro. 530, Variotro. P 530			8-18					
Variotronic 530 Akku			8-18					18
Duotronic, Profitronic				18-30				
Rally 500, Compacta N 500					6-14			
Robusta 606				15-23				
Multitronic 500					8-18			
<b>EINHELL</b>								
BT-EN 30 E				15-25				15-32
<b>FIXIT</b>								
M 100, S 100			x					
M 100 B			x					x
200			x					x
400			x					x
<b>IRONSIDE</b>								
1000			x					
1500					x			
2500					x			
2000			x					x
2200			x					x
2600					x			x
<b>KWB</b>								
T 6			6-8			6-8		
T 8, T 9, PT 6, PT 8			4-8					
PT 10			4-10					
T 14			4-14					
PT 14 N, TT 14			6-14					16
T 15								12-14
T 17			4-17					12-16
PT 18 N			8-18					19
MT 10			6-10					
MT 16 N			8-16					16
MT 20 N			8-20					16-19
TN 30								16,19
TT 13			6-14					
TT 18			8-20					16,19
TT 19			8-18					19
TT 19 S			8-18	14-18				19
TT 26				12-26				16-25
TT 28			14-18	12-28				19-28
TT 30				18-30				16-30
TT 42				15-32				
HAT 053			4-8					
HAT 057					6-10			





# Bevestigingsmiddelen voor hand- en elektrische tackers

		Nieten						Nagels
kwb-type		052	053	055	057	058	059	055
Art.-nr.		352-	353- 053-	355-1 055-5	357-	358- 058-	359-	355-7 055-7
 ↓ mm		6-14	4-20	12-30	6-18	8	6-14	12-30
Fabrikant/machinetype								
<b>KWB</b>								
AT 14			6-14					
AT 32				12-33				
<b>KIHLBERG</b>								
7 T 70					x			
7 T 72					x			x
<b>LUX</b>								
Decotacker			6-8			6-8	6-8	16
Multitacker, Profitacker						6-14		16
Tackermatic-Elektronik				12-18		8-18		19/20
Tackermatic P								16
Mini			4-8					
Maxi								
195000, 195010, 195020,			6-8/14					
195030, 195050			6-8/14					
195015, 195040, 195060			6-8/14					16
195055					6-14			
HHT mini 196250			6-8					
HHT mini 196251					6-10			
<b>MAESTRI</b>								
Rocama 104/107, 104/107CA			6-8					
Rocama 104/707SA			6-8					
105/108/110			6-10					
TH 53/8 - TAK 53/8			4-8					
THB 53/8			4-8					
THB 53/10 - TAK 53/10B			4-10					
THB 53/14 - TAK 53/14B			6-14					16
5314/5310			6-14					
5316			6-16					16
53 Elektronik			8-20					19
EHB T 50, T 50 Elektronik					6-14			
ME 4/606 Elektronik				12-26				16-25
Technika 1310							4-10	
ME 30, MET 30								16-30
<b>MAXICRAFT</b>								
10200, 10201, 10202, 10203			x					
10211, 10301, 10302, 10303			x					
10401			x					
10204, 10220E			x					x
10416, 10417, 10510			x					x
10408			x			x		
10420							x	
<b>METABO</b>								
TA E 1819			8-18					19
TA E 1919, 2019 (.00)			8-18	12-18				19
TA E 2019 (.50)			8-18	12-18				19
TA E 3030				18-30				16-30
TA M 2020			8-18	12-18				19
TA M 3034				18-30				16-30
TA A 19			8-18	12-18				19
<b>MEKANO-FISCHER-DAREX</b>								
Mini 4			4-6					
Maxi 10, MEK 10			4-10					
Hyper 16, MEK 16, MEK 20					6-14			
H 100			6-14					
MEK 116			6-14					15

		Nieten						Nagels
kwb-type		052	053	055	057	058	059	055
Art.-nr.		352-	353- 053-	355-1 055-5	357-	358- 058-	359-	355-7 055-7
 ↓ mm		6-14	4-20	12-30	6-18	8	6-14	12-30
Fabrikant/machinetype								
<b>MEKANO-FISCHER-DAREX</b>								
MEK 1020			8-14					15-19
C 300								
<b>MÜLLNER</b>								
T 8, HT 08			4-8					
HT 01			6-8					
TP 53-10, TM 53-10			4-10				4-10	10
HT 5310, HT 5310M			4-10				4-10	10
T 14			4-14					
TP 53-14, HT 16, TE 53-14			6-14					16
TM 53-16			6-16				4-16	16
HT 5316K, HT 5316M			6-16				4-16	16
HT 18			6-18					
TP 53-16			8-18					16
TM 53-20, TE 53-20			8-20					16
TE 4-25				12-26				19-26
TH 11-10, HT 031					6-10			
ET 5314			4-14					15
DT 5316			4-16					
DT 440				15-40				
<b>NOVUS</b>								
J-01, J-01 A, J-01 AS			6-8					
J-02			4-6					
J-02 H							4-8	
J-02 AL			6-14					
J-03						6-8		
J-06			4-8			4-8		
J-08, J-08 ABH, J-09 ABH			4-8			4-8	4-8	
J-08 XX			4-8		4-6	4-8	4-8	
J-09 XX			4-8		4-6	4-8	4-8	
J-14			4-17			4-17		16
J-15						6-14		16
J-16, J-16 EAD, J-19 EAD			6-14					16
J-16 EADHG			6-14		6-14		6-14	16
J-17, J-100			6-14					16
J-17 DA			6-14					
J-18			6-18					16
J-19 EHG					6-14		6-14	16
J-19 EADHG			6-14		6-14		6-14	16
J-021 H							4-6	
J-031 G, J-030 G					6-10			
J-58 Trig						6-15		
J-102 DA			6-14					
J-105 EADHG			6-14		6-14		6-14	16
J-141, J-145			8-18	12-18				19
J-155 A, J-155, J-219			8-18	12-18				19
J-165 EAD			8-20					16-19
J-165 EC				15-26				16-25
J-170				18-26				16-30
J-170 N								16-30
J-171, J-172 A, J-230				18-30				16-30
J-214 EA			6-14					14
J-316 A			6-16	15-28				16-30
J-328 EC								
<b>NECKERMANN</b>								
siehe BULLCRAFT								

		Nieten						Nagels
	kwb-type	052	053	055	057	058	059	055
	Art.-nr.	352-	353- 053-	355-1 055-5	357-	358- 058-	359-	355-7 055-7
	 ↓ mm	6-14	4-20	12-30	6-18	8	6-14	12-30
Fabrikant/machinetype								
<b>PEUGEOT</b>								
Pactronic 14 A, AG 14 A								
Rafale								
<b>PIRANHA</b>								
X 70101, 70102								
X 70004								
X 70005, 70006								
<b>PROXON</b>								
AT 1000								
<b>RAPESCO</b>								
53 EL								
913								
853-D/T/P								
13 EL								
813-D/T/P								
140 EL								
A 11								
HD 140								
180 EL, 181 EL								
Z 140								
Z1-P/Z1								
Z2-P/Z2								
<b>RAPID</b>								
MS813, R83, ESN113								
MS840, R64, CSN140,								
ESN114, E-Tac								
MS853, R453, E100R, ESN530								
R553								
MS4.1								
R34, R44								
M10R, R153								
M10Y, R23								
M20R, M30								
M20Y								
M40								
MS610								
R13								
R14, 24								
R253, R353								
R30								
R33, 136, BLT								
R53								
EN330, PN15-30								
PN15-50								
R606								
PSN15-30								
18G								
PS6-16								
R11, 131, 132								
R19								
R211								
R54								
35, 135								
<b>REXEL</b>								
2001								
Lo-Line								

		Nieten						Nagels
	kwb-type	052	053	055	057	058	059	055
	Art.-nr.	352-	353- 053-	355-1 055-5	357-	358- 058-	359-	355-7 055-7
	 ↓ mm	6-14	4-20	12-30	6-18	8	6-14	12-30
Fabrikant/machinetype								
<b>REXEL</b>								
Rexel 37, Titan 12H, Titan Twin							x	
Titan 12H							x	
Titan Twin							x	
<b>ROCAGRAF</b>								
ROC 14, 11			4-8			4-8	4-8	
ROC 36						6-15		15
ROC 220						6-15		15
ROC 66			6-18			6-17		15
ROC 310								15
Modell 11/Colibri			4-6					
Modell 55, Junior 3, Fix 3						6-14		
Junior 4, ME 30								15-30
Fix 102, 103			4-8					
Fix 106			4-14					
MS 50 V					6-14			
Modell 14						6+8		
<b>ROCAFIX</b>								
EN 330								15-30
ES 230			6-14					15
ES 130					6-14			15
HS 21			6-8					
HS 50					6-10			
MS 05			4-8					
MS 10			6-12			6-15		
MS 100-110			4-8				4-8	
MS 15					6-12			
MS 20			6-12					
MS 30, 40			6-12					15
MS 35					6-12			15
MS 50 V					6-14			
MS 500					6-14			
MS 500B			6-14					
<b>RONDY</b>								
50					x			
60			x					
<b>SKANDIA</b>								
Modell 34.85.101			4-8					
Modell 34.85.103			4-14					
<b>SKIL</b>								
16 H								
<b>STANLY-BOSTITCH</b>								
Hobby 8, Pro 8			6-8					16
Pro 14					6-14			
ST 10			6-10					
ST 14			6-14					16
T 200, TR 100 M2					6-14			
TGD, TGA						6-12		
TR 100					6-14			
TR 200					6-14			16
TR 45			6-10					
TR 250					6-14			12-16
TR 150 HL, TR 151 Y					6-14			
TR 150 L			6-14					12-16
TR 151 YL			6-14					
Hammertacker					6-10			

		Nieten						Nagels
	kwb-type	052	053	055	057	058	059	055
	Art.-nr.	352-	353- 053-	355-1 055-5	357-	358- 058-	359-	355-7 055-7
	 ↓ mm	6-14	4-20	12-30	6-18	8	6-14	12-30
Fabrikant/machinetype								
<b>STANLY-BOSTITCH</b>								
PHT 150					6-10			
<b>SWINGLINE</b>								
90						4-8		
101						6-8		
813, 913						6-12		
800X, 1000, Klammermatic								
Modell 900, 10060, 34201								
Powermatic, Typ 800								
Wammer II								19-25
Wammer 2001, Nagelmatic								25
<b>WOLFCRAFT</b>								
tacocraft 4			6-8					
tacocraft P 10			4-10					
tacocraft P 14 +			6-14					
tacocraft M 10			4-10					
tacocraft M 14 +			6-14					
tacocraft HT 8			4-8					
tacocraft HT 10					6-10			
Taco 8, 7001/02, 7005/06			4-8					
Taco10			4-10					
Taco 14			6-14					16
7003/04, 7007/08			4-14					
7100, 7110			8-18					
Tacomat		6-14						
7160, 7162				18-30				
7165				16-23				
DL 26				12-26				16-25
ET 20			8-18					16

**Hetelijmpistool GLUE GUN FL528 FC**



Voor snelle en duurzame lijmverbindingen bij het knutselen, repareren, decoreren. De alleslijm voor huis, werkplaats en hobby. Heel nauwkeurig lijmen van metalen, glas, keramiek, marmer, hout, leer, textiel, kunststof (behalve PP, PE, styropor). De lijm is weerbestendig. Lijmt voorwerpen voor zowel binnen- als buitengebruik. Netaansluiting AC 230 V / 50 Hz, opwarmtijd 3-5 min, opwarmtemperatuur 195 °C, transportcapaciteit 14-16 g/min, kabellengte 140 cm, gewicht 255 g.

Art.-nr.	Inhoud	Vermogen	Stickdiameter			EAN
538320	Hetelijmpistool GLUE GUN FL528 FC, 2 lijmsticks Ø 11 mm + toebehoren	20 W (80 W)	11			4 009315 383200

**Hetelijmpistool GLUE GUN FL007**



Voor snelle en duurzame lijmverbindingen bij het knutselen, repareren, decoreren. De alleslijm voor huis, werkplaats en hobby. Heel nauwkeurig lijmen van metalen, glas, keramiek, marmer, hout, leer, textiel, kunststof (behalve PP, PE, styropor). De lijm is weerbestendig. Lijmt voorwerpen voor zowel binnen- als buitengebruik. Netaansluiting AC 230 V / 50 Hz, opwarmtijd 3-5 min, opwarmtemperatuur 195 °C, transportcapaciteit 8-12 g/min, kabellengte 140 cm, gewicht 220 g.

Art.-nr.	Inhoud	Vermogen	Stickdiameter			EAN
538211	Hetelijmpistool GLUE GUN FL007, 2 lijmsticks Ø 11 mm	25 W (70 W)	11			4 009315 382111

**Hetelijmpistool GLUE GUN FL005**



Voor snelle en duurzame lijmverbindingen bij het knutselen, repareren, decoreren. De alleslijm voor huis, werkplaats en hobby. Heel nauwkeurig lijmen van metalen, glas, keramiek, marmer, hout, leer, textiel, kunststof (behalve PP, PE, styropor). De lijm is weerbestendig. Lijmt voorwerpen voor zowel binnen- als buitengebruik. Netaansluiting AC 230 V / 50 Hz, opwarmtijd 5-7 min, opwarmtemperatuur 195 °C, transportcapaciteit 6-8 g/min, kabellengte 120 cm, gewicht 135 g.









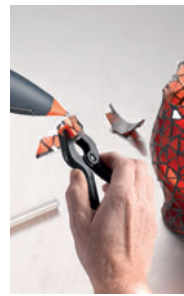





Art.-nr.	Inhoud	Vermogen	Stickdiameter			EAN
538207	Hetelijmpistool GLUE GUN FL005, 2 lijmsticks Ø 7 mm	10 W	7			4 009315 382074

## Lijmsticks



Lijmsticks, transparant, krachtige smeltlijm voor metaal, hout, kunststof, keramiek, karton, leer, schuimstof en textiel, sterke en duurzame hechting.



Art.-nr.	Ø mm	Inhoud	Lengte			EAN
538906	7	6 st.	100		6	 4 009315 389066
539006	11	6 st.	100		6	 4 009315 390062
539020	11	20 st.	100		6	 4 009315 390208
539306	11	6 st.	200		6	 4 009315 393063
539320	11	20 st.	200		6	 4 009315 393209
539350	11	50 st.	200		1	 4 009315 393506

## kwb-info



### Werken zoals een professionele meubelmaker – met de ,lijmpatronen‘ van hout

Rekken en kasten kunnen nu nog sneller worden gebouwd. De voorgelijmde houten deuvels van kwb gewoon even in water dompelen en ze zijn klaar om te worden verwerkt. Het doseren van houtlijm in de werkstukken is niet meer

nodig, het uitlopen van lijm bij het samenpersen van hoogwaardige meubeldelen is niet meer mogelijk. U hoeft geen houtlijm meer te kopen en het probleem van uitgedroogde lijmtubes behoort definitief tot het verleden.

... altijd de passende toebehoren voor uw machine!





# BEVESTIGEN HOUTEN DEUVELS

## Bevestigen, houten deuvels



### Bevestigen, houten deuvels

- **DÜBELPROFI**, de gepatenteerde deuveld-boormal voor het voorboren van perfect passende deuvelgaten.
- **Professionele scharniergatboormal** voor het boren van perfect passende scharniergaten
- **Houten deuvels** voor verwerking met houtlijm in meubel industrie

## Programma overzicht



### Dübelprofi ★★★★★

Een gepatenteerde deuveld-boormal voor perfect passende 90°-boringen op gladde oppervlakken zoals tegels en deuvelgaten in hout voor meubel industrie.

Pagina 332



### Professionele scharniergat boormal ★★★★★

Voor het voorboren van perfect passende scharniergaten met een scharniergat- of forstnerboor in de meubel industrie.

Pagina 332



### Houten- en platte deuvels ★★★★★

Voor verwerking met houtlijm in meubel industrie.

Pagina 334



### Houten proppen (conisch) ★★★★★

Als afdekkapjes voor gaten in houten en gelamineerde houten constructies.

Pagina 335

kwb-info

## Werken zoals professionele meubelmakers



### Getest in de meubel industrie

Stellingen en kasten kunnen nu nog sneller worden gebouwd. De voorgelijmde kwb houten deuvels gewoon even in water dompelen en ze zijn klaar om te worden verwerkt.

Het doseren van houtlijm in de werkstukken is niet meer nodig, het uitlopen van lijm bij het samenpersen van hoogwaardige meubeldelen is niet meer mogelijk.

U hoeft geen houtlijm meer te kopen en het probleem van uitgedroogde lijmtubes behoort definitief tot het verleden.

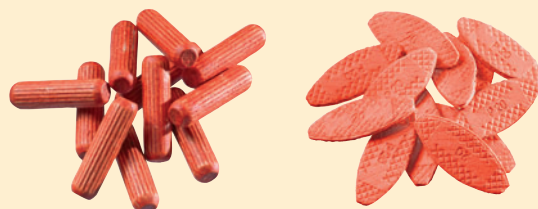

### Voorgelijmde houten en platte deuvels ★★★★★

Nadat de deuvel gewoon is bevochtigd, kan hij direct worden verwerkt. Hij verbindt zich met het werkstuk zonder dat de lijm uitloopt of naar buiten komt bij het samenpersen van de meubeldelen.

**DÜBELPROFI deugel-boormal**



DÜBELPROFI deugel-boormal, met parallelaanslag en boorgataftaster, voor hoek-, T-, haakse en vlakke verbindingen, rubberen antislip voor gladde en gevoelige oppervlakken, voor alle gangbare deugels Ø 6, 8 en 10 mm, ook geschikt als boormal voor precieze 90°-boringen van 3-12 mm.

Art.-nr.	Voor boren	Voor deugels			EAN
758000	Ø 3, 3.3, 4, 4.2, 5, 6, 6.8, 8, 10, 12 mm	Ø 6, 8, 10 mm		1	4 009317 580003

**DÜBELPROFI deugel-boormal, complete set**



DÜBELPROFI deugel-boormal, complete set met houten deugels, Ø 6, 8, 10 mm en CV-houtspiraalboren Ø 6, 8, 10 mm, met parallelaanslag en boorgataftaster, voor hoek-, T-, haakse en vlakke verbindingen, rubberen antislip voor gladde en gevoelige oppervlakken, voor alle gangbare deugels Ø 6, 8 en 10 mm, ook geschikt als boormal voor precieze 90°-boringen van 3-12 mm.

Art.-nr.	Inhoud			EAN
758100	1 deugel-boormal, 150 houten deugels, 3 houtspiraalboren		1	4 009317 581000

**PROFESSIONELE scharniergatboormal**



PROFESSIONELE scharniergatboormal, voor het maken van perfect passende scharniergaten, mobiel en stationair gebruik, voor het aanbrengen van scharnieren en beslag.

Art.-nr.	Voor deugels			EAN
759200	Ø 26, 35 mm		1	4 009317 592006

## Boordieptebegrenzer, 3-delig



Boordieptebegrenzer, voor een traploze instelling van de boordiepte, zoals bijv. bij het voorbereiden van deugelgaten, voor houtspiraalboren  $\varnothing$  6, 8 en 10 mm.

Art.-nr.	Voor boren			EAN
530300	$\varnothing$ 6, 8, 10 mm		10	4 009315 303000



## Markeerpunten



Markeerpunten, voor werkzaamheden met houten deuvels.

Art.-nr.	$\varnothing$ mm	Inhoud			EAN
530206	6	4		10	4 009315 302065
530208	8	4		10	4 009315 302089
530210	10	4		10	4 009315 302102



## Boor- en deuvselset



Boor- en deuvselset, CV-houtspiraalboor, houten deuvels, beukenhout, markeerpunten, boordieptebegrenzer, lijm, voor alle meubelverbindingen.

Art.-nr.	Inhoud			EAN
028060	1 houtspiraalboor CV ( $\varnothing$ 6 mm), 25 houten deuvels ( $\varnothing$ 6 mm), 4 markeerpunten ( $\varnothing$ 6 mm), 1 boordieptebegrenzer, 1 tube houtlijm		10	4 009310 280603
028080	1 houtspiraalboor CV ( $\varnothing$ 8 mm), 25 houten deuvels ( $\varnothing$ 8 mm), 4 markeerpunten ( $\varnothing$ 8 mm), 1 boordieptebegrenzer, 1 tube houtlijm		10	4 009310 280801
028100	1 houtspiraalboor CV ( $\varnothing$ 10 mm), 25 houten deuvels ( $\varnothing$ 10 mm), 4 markeerpunten ( $\varnothing$ 10 mm), 1 boordieptebegrenzer, 1 tube houtlijm		10	4 009310 281006



Voorgelijmde houten deuvels



Rekken en kasten kunnen nu nog sneller worden gebouwd. De voorgelijmde houten deuvels gewoon even in water dompelen en ze zijn klaar om te worden verwerkt. Het doseren van houtlijm in de werkstukken is niet meer nodig, het uitlopen van lijm bij het samenpersen van hoogwaardige meubeldelen is niet meer mogelijk. U hoeft geen houtlijm meer te kopen en het probleem van uitgedroogde lijmtubes behoort definitief tot het verleden.

Art.-nr.	Ø mm	Inhoud	Lengte			EAN
028260	6	140	30		8	4 009310 282607
028280	8	100	40		8	4 009310 282805
028300	10	60	40		10	4 009310 283000

Houten deuvels



Houten deuvels, beukenhout, geribbeld, afgekant, voor alle houtverbindingen bij meubelen.

Art.-nr.	Ø mm	Inhoud	Lengte			EAN
<b>ZB-kaart, kleine verpakking</b>						
028160	6	50	30		10	4 009310 281600
028180	8	40	40		10	4 009310 281808
028200	10	30	40		10	4 009310 282003



Art.-nr.	Ø mm	Inhoud	Lengte			EAN
<b>ZB-zak, grote verpakking</b>						
028560	6	200	30		10	4 009310 285608
028580	8	150	40		10	4 009310 285806
028600	10	120	40		10	4 009310 286001

Voorgelijmde houtverbindingenplaatjes



Rekken en kasten kunnen nu nog sneller worden gebouwd. De voorgelijmde houten deuvels gewoon even in water dompelen en ze zijn klaar om te worden verwerkt. Het doseren van houtlijm in de werkstukken is niet meer nodig, het uitlopen van lijm bij het samenpersen van hoogwaardige meubeldelen is niet meer mogelijk. U hoeft geen houtlijm meer te kopen en het probleem van uitgedroogde lijmtubes behoort definitief tot het verleden.

Art.-nr.	Inhoud	Lengte	Nummer	Gleuf			EAN
029130	50	55	0	8 mm	4	6	4 009310 291302
029140	50	60	10	10 mm	4	6	4 009310 291401
029150	40	65	20	12 mm	4	6	4 009310 291500

## Houtverbindingsplaatjes



Houtverbindingsplaatjes, beukenhout, 4 mm dik, voor alle houtverbindingen bij meubelen gangbare dikten van houtplaten.

Art.-nr.	Inhoud	Lengte	Nummer	Gleuf	+	+	+	EAN
029100	50	15	0	8 mm	4	+	+	4 009310 291005
029110	50	19	10	10 mm	4	+	+	4 009310 291104
029120	50	23	20	12 mm	4	+	+	4 009310 291203



## Conische plaatjes



Grenen, gemaakt van dwarshout, voor de reparatie van fouten in hout en knoestgaten en als afdekstop voor schroefkoppen voor de verbetering van brandveiligheid bij hout en gelamineerde houten constructies.

Art.-nr.	Ø mm	Inhoud	+	+	+	EAN
032115	15	50	10	+	+	4 009310 321153
032120	20	40	10	+	+	4 009310 321207
032125	25	20	10	+	+	4 009310 321252
032130	30	10	10	+	+	4 009310 321306
032135	35	10	10	+	+	4 009310 321351
032140	40	8	10	+	+	4 009310 321405



... altijd de passende toebehoren voor uw machine!



# TOEBEHOREN VOOR HAAKSE SLIJPERS

Doorslijp- en schuurschijven  
Diamantdoorslijpschijven  
Draadborstels



## Doorslijpschijven



### Voor gebruik in alle gangbare haakse slijpers

- Doorslijpschijven, schuurschijven, lamellenslijpers, reinigingsschijven, fiberschijven
- Diamantdoorslijpschijf

## Programma overzicht



### CUT-FIX® doorslijpschijf, ★★★★★ extra dun

Extra dunne doorslijpschijf voor het zagen van metalen uit staal en roestvrij staal, met een hoge levensduur.

Pagina 340



### CUT-FIX® doorslijpschijf, ★★★★★

Hoogwaardige doorslijpschijf voor professioneel continu gebruik op metalen en stenen.

Pagina 341

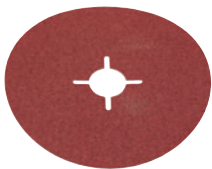

### AGGRESSO-FLEX® ★★★★★ fiberschijven

Voor zware slijp- en reinigingswerkzaamheden in de staal- en metaalbouw, voor het ontroesten, verwijderen van verf, hamerslag en lak, voor het reinigen van lasnaden.



Pagina 343 - 344



### AGGRESSO-FLEX® ★★★★★ diamantdoorslijpschijven GOLD-Line

Gesloten snijrand, turbovorm, ideaal voor graniet, beton, klinkers, dakpannen, alle soorten natuur- en kunststeen, hard gebakken tegels.



Pagina 345



### AGGRESSO-FLEX® ★★★★★ diamantdoorslijpschijven BLACK-Line

Lasergelast, gesegmenteerde snijrand, turbovorm, ideaal voor graniet, betonsteen, uitgewassen beton, alle soorten natuur- en kunststeen.



Pagina 345



### AGGRESSO-FLEX® ★★★★★ diamantdoorslijpschijven WHITE-Line

Gesloten snijrand, turbovorm, voor tegels, keramiek, travertijn, marmer.



Pagina 345

## Doorslijpschijven, borstels



### CUT-FIX® doorslijpschijf ★★★★★ RED-Line

Gesloten snijrand, turbovorm, ideaal voor marmer, holle bouwstenen, dakpannen, keramische materialen, tegels.

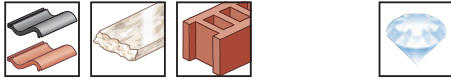

Pagina 346



### CUT-FIX® doorslijpschijf ★★★★★ GREEN-Line

Lasergelast, gesegmenteerde snijrand, turbovorm, ideaal voor bakstenen, betonstenen, klinkers.



Pagina 346



### AGGRESSO-FLEX® ★★★★★ dunne diamantdoorslijpschijven

Extra dunne, gesloten snijrand, turbovorm, ideaal voor gres, tegels, keramiek.



Pagina 346



### AGGRESSO-FLEX® ★★★★★ diamantschuurschijven

Lasergelast, één rij diamantsegmenten, voor zware schuur- en reinigingswerkzaamheden, ideaal voor beton, ondervloeren, muurpleister, mortel, natuursteen.



Pagina 347

## Borstels



### Voor gebruik in alle gangbare haakse slijpers

- Schijf-, kom- en kegelborstels
- HSS-staaldraad, gevlochten
- Voor het ontroesten, verwijderen van dek-lagen
- Voor het afbikken, ontbramen
- Geschikt voor metaal en steen



### AGGRESSO-FLEX® ★★★★★ komborstels

Met gegolfde en gevlochten HSS-draad, voor zware reinigingswerkzaamheden en het verwijderen van verf, ontroesten, ontslakken en afbikken op middelgrote oppervlakken.

Pagina 348



### AGGRESSO-FLEX® ★★★★★ schijfborstels

Met grove, gevlochten HSS-staaldraad, voor zware reinigingswerkzaamheden, vooral op moeilijk toegankelijke plaatsen, voor het ontbramen, ontroesten, afbikken, ontslakken, verwijderen van verf en tectyl.

Pagina 349

**CUT-FIX<sup>®</sup> doorslijpschijven extra dun, metaalbewerking**



Doorslijpschijven, extra dun, metaalbewerking, optimale prestaties, zeer gemakkelijke aansnijding, hoge levensduur, bijzonder goed geschikt voor blink, buizen van staal en rvs, voor alle normaal verkrijgbare haakse slijpers met een omtreksnelheid van 80 m/s.

Art.-nr.	mm	Ø x hoogte	Schijfvorm			EAN
711911	22	115 x 1,0	---		1	4 009317 119111
711912	22	125 x 1,0	---		1	4 009317 119128
711928	22	180 x 1,4	---		1	4 009317 119289
711933	22	230 x 1,8	---		1	4 009317 119333

**CUT-FIX<sup>®</sup> doorslijpschijven extra dun, metaalbewerking, voordeelverpakking**



Doorslijpschijven, extra dun, metaalbewerking, optimale prestaties, zeer gemakkelijke aansnijding, hoge levensduur, bijzonder goed geschikt voor blink, buizen van staal en rvs, voor alle normaal verkrijgbare haakse slijpers met een omtreksnelheid van 80 m/s.

Art.-nr.	mm	Ø x hoogte	Inhoud	Schijfvorm			EAN
711921	22	115 x 1,2	10	---		1	4 009317 119210
711922	22	125 x 1,2	10	---		1	4 009317 119227
711929	22	180 x 1,6	5	---		1	4 009317 119296
711934	22	230 x 2,0	5	---		1	4 009317 119340

**kwb-info**

**Een kwestie van veiligheid**

Met name bij werkzaamheden met haakse slijpers vliegen scherpe deeltjes en stof in het rond, die, in het oog kunnen springen'. Daarom moet dit belangrijke zintuig bij al deze werkzaamheden worden beschermd. kwb heeft hiervoor een hoogwaardig assortiment veiligheidsbrillen samengesteld, dat ook voor brildraggers geschikt is.

Alle informatie hierover vindt u op internet onder [www.kwb.eu](http://www.kwb.eu)



## Doorslijpschijven

### CUT-FIX® doorslijpschijven, metaalbewerking



Doorslijpschijven, metaalbewerking, binding BF, korrel aluminiumoxide, hoogwaardige schijven voor professioneel continu gebruik, voor alle normaal verkrijgbare haakse slijpers met een omtreksnelheid van 80 m/s.

Art.-nr.	mm	Ø x hoogte	Schijfvorm			EAN
791050	16	100 x 3,0	~		25	4 009317 910503
791150	22	115 x 3,0	~		25	4 006317 9111500
791250	22	125 x 3,0	~		25	4 009317 912507
791750	22	178 x 3,0	~		25	4 009317 917502
791950	22	230 x 3,0	~		25	4 009317 919506
791970	22	230 x 3,0	~		25	4 009317 919704



### CUT-FIX® doorslijpschijven, steenbewerking



Doorslijpschijven, steenbewerking, binding BF, korrel siliciumcarbide, hoogwaardige schijven voor professioneel continu gebruik, voor alle normaal verkrijgbare haakse slijpers met een omtreksnelheid van 80 m/s.

Art.-nr.	mm	Ø x hoogte	Schijfvorm			EAN
792050	16	100 x 3,0	~		25	4 009317 920502
792150	22	115 x 3,0	~		25	4 009317 921509
792250	22	125 x 3,0	~		25	4 009317 922506
792750	22	178 x 3,0	~		25	4 009317 927501
792950	22	230 x 3,0	~		25	4 009317 929505
792970	22	230 x 3,0	~		25	4 009317 929703



### CUT-FIX® schuurschijven, metaalbewerking



Schuurschijven, metaalbewerking, binding BF, korrel aluminiumoxide, hoogwaardige schijven voor professioneel continu gebruik, voor alle normaal verkrijgbare haakse slijpers met een omtreksnelheid van 80 m/s.

Art.-nr.	mm	Ø x hoogte	Schijfvorm			EAN
793165	22	115 x 6,0	~		10	4 009317 931652
793265	22	125 x 6,0	~		10	4 009317 932659
793765	22	178 x 6,0	~		10	4 009317 937654
793965	22	230 x 6,0	~		10	4 009317 939658



**CUT-FIX<sup>®</sup> schuurmop, lamellenschuurschijf, metaalbewerking**

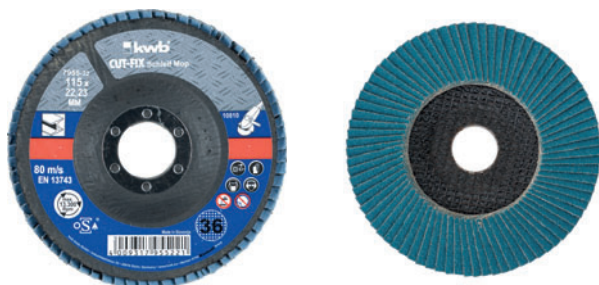

Schuurmop, lamellenschuurschijf, metaalbewerking, schuurkorrel zirkoonkorund, hoog aantal lamellen voor een optimaal schuurpatroon, voor professioneel continu gebruik, voor alle gewoon verkrijgbare haakse slijpers met een omtreksnelheid van 80 m/s.

Art.-nr.	Ø x houder-Ø	Korrel	Max. rpm			EAN
795522	115 x 22	36	13.300		10	4 009317 955221
795524	115 x 22	40	13.300		10	4 009317 955245
795526	115 x 22	60	13.300		10	4 009317 955269
795528	115 x 22	80	13.300		10	4 009317 955283
795724	125 x 22	40	12.200		10	4 009317 957249
795726	125 x 22	60	12.200		10	4 009317 957263
795728	125 x 22	80	12.200		10	4 009317 957287

**Reinigingsschijven**



Reinigingsschijven, nylon elementen, gebonden met siliciumcarbideschuurkorrels, bruikbare breedte 13 mm, werkt met precieze rand, schuurt met front- of zijvlak, flexibel, voor het schuren en reinigen van staal, blik, hout, kunststof en steen, voor alle normaal verkrijgbare haakse slijpers met een omtreksnelheid van 80 m/s.

Art.-nr.	Ø x houder-Ø	Max. rpm			EAN
<b>ZB-verpakking</b>					
479211	115 x 22	11.000		1	4 009314 792119
479311	125 x 22	9.800		1	4 009314 793116

Art.-nr.	Inhoud			EAN
<b>display</b>				
479292	20 schijven Ø 115 x 22 mm		Z20	4 009314 792928
479392	20 schijven Ø 125 x 22 mm		Z20	4 009314 793925







## Toebehoren voor haakse slijpers



### CUT-FIX® fiberschijven, metaalbewerking







Fiberschijven, metaalbewerking, drager vulcanfiber, schuurkorrel van aluminiumoxide, gebonden met volledig synthetisch hars, voor zware schuur- en reinigingswerkzaamheden, voor staal- en metaalbouw, om te ontroesten, verf, hamerslag en lak te verwijderen en lasnaden te reinigen, voor alle normaal verkrijgbare haakse slijpers met een omtreksnelheid van 80 m/s.



Art.-nr.	Ø x houder-Ø	Inhoud	Korrel			EAN
<b>ZB-manchet</b>						
714104	115 x 22	5	40		10	4 009317 141044
714108	115 x 22	5	80		10	4 009317 141082
714110	115 x 22	5	100		10	4 009317 141105
714112	115 x 22	5	120		10	4 009317 141129

Art.-nr.	Ø x houder-Ø	Korrel			EAN
<b>los</b>					
714122	115 x 22	24		10	4 009317 141228
714124	115 x 22	40		20	4 009317 141242
714126	115 x 22	60		20	4 009317 141266
714128	115 x 22	80		20	4 009317 141280
714130	115 x 22	100		20	4 009317 141303

Art.-nr.	Ø x houder-Ø	Korrel			EAN
<b>los</b>					
714222	125 x 22	24		10	4 009317 142225
714224	125 x 22	40		20	4 009317 142249
714226	125 x 22	60		20	4 009317 142263
714228	125 x 22	80		20	4 009317 142287
714230	125 x 22	100		20	4 009317 142300

Art.-nr.	Ø x houder-Ø	Korrel			EAN
<b>los</b>					
714322	178 x 22	24		10	4 009317 143222
714324	178 x 22	40		20	4 009317 143246
714326	178 x 22	60		20	4 009317 143260
714328	178 x 22	80		20	4 009317 143284
714330	178 x 22	100		20	4 009317 143307
714332	178 x 22	120		20	4 009317 143321



**CUT-FIX<sup>®</sup> fiberschijven, metaalbewerking**



Fiberschijven, metaalbewerking, drager vulcanfiber, schuurkorrel van aluminiumoxide, gebonden met volledig synthetisch hars, voor zware schuur- en reinigingswerkzaamheden, voor staal- en metaalbouw, om te ontroesten, verf, hamerslag en lak te verwijderen en lasnaden te reinigen, voor alle normaal verkrijgbare haakse slijpers met een omtreksnelheid van 80 m/s.

Art.-nr.	Ø x houder-Ø	Inhoud	Korrel			EAN
<b>Professionele voordeelverpakking</b>						
715824	115 x 22	10	24		5	4 009317 158240
715840	115 x 22	10	40		5	4 009317 158400
715860	115 x 22	10	60		10	4 009317 158608
715880	115 x 22	10	80		10	4 009317 158806

**Steunschijf voor haakse slijper**



Steunschijf, elastisch, met spanmoer, conisch, voor het gebruik van fiberschijven op alle normaal verkrijgbare haakse slijpers.

Art.-nr.	Ø mm	Schroefdraad			EAN
718111	115	M14		5	4 009317 181118
718112	125	M14		5	4 009317 181125

**kwb-info**

**Een kwestie van veiligheid**

Met name bij werkzaamheden met haakse slijpers vliegen scherpe deeltjes en stof in het rond, die, in het oog kunnen springen'. Daarom moet dit belangrijke zintuig bij al deze werkzaamheden worden beschermd. kwb heeft hiervoor een hoogwaardig assortiment veiligheidsbrillen samengesteld, dat ook voor brildraggers geschikt is.

Alle informatie hierover vindt u op internet onder [www.kwb.eu](http://www.kwb.eu)















## Diamantdoorslijpschijven

### AGGRESSO-FLEX® Gold-Line DIAMANT-doorslijpschijven



Gold-Line DIAMANT-doorslijpschijven, gesloten rand, turbovorm, dikte 10 mm, voor een hoog snijvermogen bij een professioneel continu gebruik, voor graniet, beton, klinkers, dakpannen van klei en beton, alle soorten natuur- en kunststeen, hard gebakken tegels, voor alle normaal verkrijgbare haakse slijpers met een omtreksnelheid van 80 m/s.











Art.-nr.	Ø x houder-Ø	 x  mm			EAN
722140	115 x 22	7,0 x 2,1		1	
722540	125 x 22	7,0 x 2,3		1	
722840	230 x 22	7,0 x 2,8		1	



### AGGRESSO-FLEX® Black-Line DIAMANT-doorslijpschijven



Black-Line DIAMANT-doorslijpschijven, gesegmenteerde snijrand, lasergelast, turbovorm, dikte 10 mm, voor een hoog snijvermogen bij professioneel continu gebruik, voor graniet, betonstenen, uitgewassen beton en alle natuur- en kunststeensoorten, voor alle normaal verkrijgbare haakse slijpers met een omtreksnelheid van 80 m/s.













Art.-nr.	Ø x houder-Ø	 x  mm			EAN
723140	115 x 22	7,0 x 1,9		1	
723540	125 x 22	7,0 x 1,9		1	
723840	230 x 22	7,0 x 2,4		1	



### AGGRESSO-FLEX® White-Line DIAMANT-doorslijpschijven



White-Line DIAMANT-doorslijpschijf, gesloten rand, turbovorm, dikte 5 mm voor een hoog snijvermogen bij professioneel continu gebruik, voor tegels, keramiek, travertijn en marmer, voor alle normaal verkrijgbare haakse slijpers met een omtreksnelheid van 80 m/s.

Art.-nr.	Ø x houder-Ø	 x  mm			EAN
725140	115 x 22	5,0 x 1,8		1	
725240	125 x 22	5,0 x 1,9		1	
725750	178 x 25,4/22	5,0 x 2,2		1	
725840	230 x 22	5,0 x 2,5		1	



**CUT-FIX<sup>®</sup> Red-Line DIAMANT-doorslijpschijven**



Red-Line DIAMANT-doorslijpschijven, gesloten rand, turbovorm, dikte 7 mm, voor marmer, holle bouwstenen, betonnen dakpannen, keramische materialen en tegels, voor alle normaal verkrijgbare haakse slijpers met een omtreksnelheid van 80 m/s.

Art.-nr.	Ø x houder-Ø	mm			EAN
797140	115 x 22	7,0 x 2,1		1	4 009317 971405
797540	125 x 22	7,0 x 2,3		1	4 009317 975403
797840	230 x 22	7,0 x 2,8		1	4 009317 978404

**CUT-FIX<sup>®</sup> Green-Line DIAMANT-doorslijpschijven**



Green-Line DIAMANT-doorslijpschijven, gesegmenteerde snijrand, lasergelast, turbovorm, dikte 7 mm, voor een hoog snijvermogen, voor bakstenen, betonnen stenen, klinkers, voor alle normaal verkrijgbare haakse slijpers met een omtreksnelheid van 80 m/s.

Art.-nr.	Ø x houder-Ø	mm			EAN
798140	115 x 22	7,0 x 1,6		1	4 009317 981404
798540	125 x 22	7,0 x 1,9		1	4 009317 985402
798740	178 x 22	7,0 x 2,0		1	4 009317 987406
798840	230 x 22	7,0 x 2,2		1	4 009317 988403

**CUT-FIX<sup>®</sup> Tegels DIAMANT-doorslijpschijven**



DIAMANT-doorslijpschijf voor tegels, gesloten rand, turbovorm, dikte 5 mm voor een hoog snijvermogen, voor tegels en travertijn, voor alle normaal verkrijgbare haakse slijpers met een omtreksnelheid van 80 m/s.

Art.-nr.	Ø x houder-Ø	mm			EAN
795940	110 x 22	5,0 x 1,2		1	4 009317 959403

**AGGRESSO-FLEX<sup>®</sup> DIAMANT-doorslijpschijven dun**



Dunne DIAMANT-doorslijpschijven, extra dunne snijrand, turbovorm, dikte 1,2 mm, optimale prestaties, zeer gemakkelijke aansnijding, hoge levensduur, bijzonder goed geschikt voor tegels, gres en keramiek, voor alle normaal verkrijgbare haakse slijpers met een omtreksnelheid van 80 m/s.



Art.-nr.	Ø x houder-Ø	mm			EAN
721140	115 x 22	7,0 x 1,2		1	4 009317 211402
724540	125 x 22	7,0 x 1,2		1	4 009317 245407

## Diamantdoorslijpschijven

### AGGRESSO-FLEX® DIAMANT-schuurschijven



DIAMANT-schuurschijf, met één rij diamantsegmenten, lasergelast, voor zware schuur- en reinigingswerkzaamheden bij professioneel continu gebruik, voor het reinigen en schuren van beton, ondervloer, muurpleister, mortel en natuursteen, voor alle normaal verkrijgbare haakse slijpers met een omtreksnelheid van 80 m/s.







Art.-nr.	Ø x houder-Ø	 x  mm			EAN
726240	115 x 22	6		1	



### Schuurschijven; normaal korund



Schuurschijven, normaal korund, fijne korrel (60N), recht profiel, voor universele schuurwerkzaamheden op gereedschapsstaal, geschikt voor het fijnschuren van gehard en ongehard staal, bijv. spiraalboren, schroevendraaiers, beitels, kloofgereedschap, steekbeitels of snijmesses en van lasnaden, geschikt voor alle normaal verkrijgbare dubbele slijpers, om de houder aan te passen zijn verloopringen bijgevoegd.











Art.-nr.	Ø x hoogte	Korrel			EAN
<b>ZB-doos</b>					
507220	125 x 20	60 N		1	
507520	150 x 20	60 N		1	



### Schuurschijven, siliciumcarbide



Schuurschijven, siliciumcarbide, fijne korrel (80 JOT), recht profiel en zeer hard, geschikt voor het fijnschuren van hardmetalen of met hardmetaal gecoate werktuigen, machinegietijzer, aluminium, alle non-ferrometalen, glas, keramiek en steen, geschikt voor alle normaal verkrijgbare dubbele slijpers, om de houder aan te passen zijn verloopringen bijgevoegd.





Art.-nr.	 mm	Ø x hoogte	Korrel	Verl.-ring			EAN
<b>ZB-verpakking</b>							
509220	20	125 x 20	80 JOT	X0		1	
509520	32	150 x 20	80 JOT	X1		1	
509720	32	175 x 25	80 JOT	X1		1	
509820	32	200 x 25	80 JOT	X1		1	



### Slijpschijfafritser



Slijpschijfafritser, kunststof greep, met 9 geharde sterwieken, 18 mm breed, Ø 30 mm, om slijpschijven te reinigen, te slijpen en glad te maken. De sterwielen breken de korrels van het verbruikte materiaal van de slijpschijf, om een perfecte concentriciteit en optimale grip van het oppervlak te bereiken.

Art.-nr.	Ø mm	Lengte			EAN
506900	27	105		1	



**AGGRESSO-FLEX® komborstel, staaldraad, Ø 0,35 mm, gevlochten**



Komborstel, HSS-staaldraad, gevlochten, om te ontroesten, coatings, verf, hardnekkige roest en anticorrosielagen op chassis te verwijderen, bekistingsplaten en gevels te reinigen, te decaperen en te ontbramen, voor metaal en steen, voor werkzaamheden op middelgrote oppervlakken.

Art.-nr.	mm	Draad Ø mm	Ø mm			EAN
<b>ZB-doos</b>						
719106	M 14	0,35	60		2	4 009317 191063
719110	M 14	0,35	100		1	4 009317 191100

Art.-nr.	mm	Draad Ø mm	Ø mm			EAN
<b>Los in doos</b>						
719136	M 14	0,35	60		Z15	4 009317 191360
719126	M 14	0,35	100		Z8	4 009317 191261



**AGGRESSO-FLEX® komborstel, staaldraad, Ø 0,5 mm, gevlochten**



Komborstel, HSS-staaldraad, gevlochten, om te ontroesten, coatings, verf, hardnekkige roest en anticorrosielagen op chassis te verwijderen, bekistingsplaten en gevels te reinigen, te decaperen en te ontbramen, voor metaal en steen, voor werkzaamheden op middelgrote oppervlakken.

Art.-nr.	mm	Draad Ø mm	Ø mm			EAN
<b>ZB-doos</b>						
719206	M 14	0,5	66		2	4 009317 192060
719210	M 14	0,5	100		1	4 009317 192107

Art.-nr.	mm	Draad Ø mm	Ø mm			EAN
<b>Los in doos</b>						
719236	M 14	0,5	66		Z12	4 009317 192367
719226	M 14	0,5	100		Z6	4 009317 192268



**AGGRESSO-FLEX® kegelborstel, staaldraad, gevlochten**



Kegelborstel, HSS-staaldraad, gevlochten, om te ontroesten, coatings, verf, hardnekkige roest en anticorrosielagen op chassis te verwijderen, lasnaden te reinigen, te decaperen, te ontbramen, voor metaal en steen, voor werkzaamheden op smalle randen, ramen, roosters en moeilijk bereikbare vlakken.

Art.-nr.	mm	Draad Ø mm	Ø mm			EAN
<b>ZB-doos</b>						
719330	M 14	0,5	100		2	4 009317 193302

## Draadborstels

### AGGRESSO-FLEX<sup>®</sup> kegelborstel, staaldraad, gevlochten



Art.-nr.	mm	Draad Ø mm	Ø mm			EAN
<b>Los in doos</b>						
719336	M 14	0,5	100		Z8	4 009317 193364



### AGGRESSO-FLEX<sup>®</sup> schijfborstel, staaldraad, M 14, gevlochten



Schijfborstel, HSS-staaldraad, gevlochten, om te ontroesten, coatings, verf, hardnekkige roest en anticorrosielagen op chassis te verwijderen, te decaperen, te ontbramen en lasnaden te reinigen, voor metaal en steen, voor werkzaamheden op smalle randen, ramen en roosters.

Art.-nr.	mm	Draad Ø mm	Ø mm			EAN
<b>ZB-doos</b>						
719730	M 14	0,5	115		2	4 009317 197300



Art.-nr.	mm	Draad Ø mm	Ø mm			EAN
<b>Los in doos</b>						
719736	M 14	0,5	115		10	4 009317 197362



### AGGRESSO-FLEX<sup>®</sup> schijfborstel, staaldraad, gevlochten



Schijfborstel, HSS-staaldraad, gevlochten, om te ontroesten, coatings, verf, hardnekkige roest en anticorrosielagen op chassis te verwijderen, te decaperen, te ontbramen en lasnaden te reinigen, voor metaal en steen, voor werkzaamheden op smalle randen, ramen en roosters.

Art.-nr.	mm	Draad Ø mm	Ø mm			EAN
<b>ZB-doos</b>						
719530	22	0,5	115		2	4 009317 195306



Art.-nr.	mm	Draad Ø mm	Ø mm			EAN
<b>Los in doos</b>						
719536	22	0,5	115		Z10	4 009317 195368



**AGGRESSO-FLEX<sup>®</sup> pensleutel**



Pensleutel, volgens DIN 3116, voor het opspannen en losmaken van spanmoeren bij alle normaal verkrijgbare haakse slijpers.

Art.-nr.	Vorm	Opening ←mm→ x Ø			EAN
718210	recht	30 x 4		2	4 009317 182108
718310	recht	35 x 5		2	4 009317 183105
718610	Gevlochten	35 x 5		2	4 009317 186106

**AGGRESSO-FLEX<sup>®</sup> pensleutel, met spanmoer**



Pensleutel, volgens DIN 3116, met spanmoer, om de spanmoeren van de meest gangbare haakse slijpers op te spannen en los te maken.

Art.-nr.	Vorm	Opening ←mm→ x Ø			EAN
718500	recht	35 x 5		1	4 009317 185000

**AGGRESSO-FLEX<sup>®</sup> spanmoer, conisch**



Spanmoer, conisch, om fiberschijven op steunschijven voor haakse slijpers te spannen.

Art.-nr.	Schroefdraad	Opening ←mm→ x Ø			EAN
718320	M 14	35 x 5,8 + 30 x 4,8		2	4 009317 183204

**AGGRESSO-FLEX<sup>®</sup> spanmoer, vlak**



Spanmoer, vlak, om doorslijpschijven, schuurschijven en draadborstels op haakse slijpers te spannen.

Art.-nr.	Schroefdraad	Opening ←mm→ x Ø			EAN
717600	M 14	35 x 5,8 + 30 x 4,8		5	4 009317 176008

## Draadborstels

### AGGRESSO-FLEX<sup>®</sup> steeksleutel, plat



Steeksleutel, vlak, voor haakse slijper.

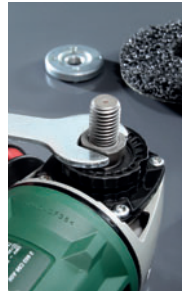

Art.-nr.	Lengte			EAN
717500	17		5	 4 009317 175001



### Haakslijperstandaard



Standaard voor haakse slijper, zijdelingse bescherming van de doorslijpschijf, terughaveer, zware uitvoering, met stabiele voetplaat, kleminrichting voor werkstukken, geschikt voor alle normaal verkrijgbare haakse slijpers.

Art.-nr.	voor			EAN
778200	Haakse slijper 115 mm		1	 4 009317 782001



**A**

Adapterset voor doppen ..... 91  
 Adapterset voor dopsleutels ..... 91  
 Afrondfrezen ..... 208  
 AGGRESSO-FLEX® DIAMANT-doorslijpschijven ..... 345  
 AGGRESSO-FLEX® DIAMANT-doorslijpschijven dun ..... 346  
 AGGRESSO-FLEX® DIAMANT-schuurschijven ..... 347  
 AGGRESSO-FLEX® kegelborstels ..... 348  
 AGGRESSO-FLEX® komborstels ..... 348  
 AGGRESSO-FLEX® pensleutel ..... 350  
 AGGRESSO-FLEX® schijfborstels ..... 349  
 AGGRESSO-FLEX® spanmoer ..... 350  
 AGGRESSO-FLEX® steeksleutel ..... 351  
 AGGRESSO-FLEX® steunschijf ..... 344  
 Antennefrezen ..... 112  
 As flexibel ..... 114

**B**

Beitel SDS-max ..... 32, 33, 34  
 Beitel SDS-plus ..... 39, 40  
 Bekistingsboren ..... 64, 65  
 Betonboren ..... 42  
 Beton- en steenboren ROCKER® ..... 42, 43  
 Beton- en steenborenssets ROCKER® ..... 43, 44  
 Beton- en steenborensset SUPER ROCKER® ..... 45  
 Beton- en steenboren SUPER ROCKER® ..... 44  
 Bimetalen HSS-gatenzagen ..... 129, 130, 131  
 Bimetalen HSS-gatenzagenset ..... 131  
 Bimetalen universeel invalzaagblad ..... 239  
 Bitboxen ..... 80, 82, 83, 85, 86, 89  
 Bit- en boorhulpstuk ..... 78  
 Bit- en doppenset STANDAARD ..... 93  
 Bithouder ..... 77  
 Bithouders ..... 76  
 Bits ..... 79, 81, 84, 86, 87, 90, 93  
 Bits, DIAMANT-coating ..... 79  
 Bitset ..... 92  
 Bitsets ..... 92  
 Bitset STANDAARD ..... 93  
 Bits, ISO-TEMP ..... 84  
 Bits, RVS ..... 86  
 Bits STANDAARD ..... 87, 90, 93  
 Bits, TITAN genitreerd ..... 81  
 Boordieptebegrenzerset ..... 333  
 Boor- en deuvvelset ..... 333  
 Boorhouder ..... 102, 103  
 Boorhulp ..... 132  
 Boorhulpstuk ..... 78  
 Boorkronen ..... 128  
 Boormachinehouder ..... 114  
 Boormachinetoehorenset mini ..... 109  
 Boormal ..... 133  
 Boormobiel ..... 114  
 Boorstandaard ..... 114  
 Borstels ..... 144, 145, 146, 147, 148, 149, 150  
 Bovenfrezen ..... 206, 207, 208, 209, 210

**C**

Cellenbetonzaagbladen ..... 238  
 Centerboren ..... 70  
 Centreerboren ..... 128, 130  
 Centreerboren voor gatenzagen ..... 135  
 Cirkelsnijder ..... 56  
 Combi-borenssets ..... 27  
 Combi-pomp P60 ..... 118  
 COMPACTA pomp P57 ..... 118  
 Conische plaatjes ..... 335  
 CROSS-TIP hamerboren ..... 41  
 CUT-FIX® DIAMANT-doorslijpschijven ..... 346  
 CUT-FIX® doorslijpschijven ..... 340, 341  
 CUT-FIX® doorslijpschijven, metaalbewerking ..... 341

CUT-FIX® fiberschijven ..... 343, 344  
 CUT-FIX® Red-Line DIAMANT-doorslijpschijven ..... 346  
 CUT-FIX® schuurmop ..... 342  
 CUT-FIX® schuurschijven ..... 341  
 CV-invalzaagblad ..... 239

**D**

Decoupeerzaagbladen ..... 224, 226, 228, 229, 230, 231, 232  
 Decoupeerzaagbladen DIAMANT ..... 228  
 Decoupeerzaagbladen DOWN CUT ..... 226  
 Decoupeerzaagbladen EASY CUT ..... 224, 229, 230  
 Decoupeerzaagbladen, houtbewerking, T-schacht ..... 225  
 Decoupeerzaagbladen LAMINAAT ..... 227  
 Decoupeerzaagbladenset ..... 228, 230, 232  
 DIAMANT decoupeerzaagbladen ..... 228  
 DIAMANT-doorslijpschijven AGGRESSO-FLEX® ..... 345  
 DIAMANT-doorslijpschijven CUT-FIX® ..... 346  
 DIAMANT-doorslijpschijven dun AGGRESSO-FLEX® ..... 346  
 DIAMANT-gatenzagen ..... 132, 133  
 DIAMANT gecoat bits ..... 79  
 DIAMANT-schuurschijven ..... 347  
 Diamantzaagblad ..... 240  
 Doorslijpschijven ..... 345, 346  
 Doorslijpschijven CUT-FIX® ..... 340, 341  
 Dopsleutels ..... 91  
 Draadborstelsets ..... 148  
 dubbelebitset ..... 92  
 DÜBELPROFI deuvvel-boormal ..... 332  
 DÜBELPROFI deuvvel-boormal, complete set ..... 332  
 Dunne doorslijpschijven ..... 346

**E**

EASY CUT decoupeerzaagbladen ..... 224, 229, 230  
 EASY CUT reciprozaagbladen ..... 233, 237  
 EASY CUT reciprozaagbladen, metaalbewerking ..... 236  
 EASY CUT universele boren ..... 52, 53  
 EASY CUT universele hamerboren ..... 52  
 ECONOMY bitset ..... 92  
 ECONOMY dubbelebitset ..... 92  
 Elektrische tacker TACKERTRONIX® ..... 314

**F**

Fasefrezen ..... 208  
 FCE-hardhoutboren ..... 60  
 Fiberschijven CUT-FIX® ..... 343, 344  
 Flexibele as ..... 114  
 Forstnerboren ..... 68  
 Freesboren ..... 113  
 Freesboren HSS TITAN ..... 112  
 Frezen ..... 107, 108, 112

**G**

Gatenzagen ..... 129, 130, 131, 132, 134, 136, 137, 138, 139, 140  
 Gatenzagenset ..... 133, 135, 140  
 Glasboren ..... 55  
 gleufbeitel ..... 34, 40  
 Gleuffrezen ..... 206, 207, 209  
 Gleuffrezen, schijfgleuffrees ..... 210  
 Graveerfrezen ..... 209  
 Gresboren ..... 54

**H**

Haaks bit- en boorhulpstuk ..... 78  
 Haaks boorkop-hulpstuk ..... 104  
 Haakse bithouder ..... 78  
 Haakseslijperstandaard ..... 351  
 Hakenschroever ..... 92  
 Hamerboor SDS-max ..... 32  
 Hamerboren CROSS-TIP ..... 41  
 Hamerboren HB 44 SDS-plus ..... 35, 36, 37, 38  
 Hamerborenssets ..... 38  
 Hamertacker ..... 314  
 Hamertackers ..... 314



Handschourblok.....	196, 197	LINE MASTER liniaalverbinder.....	219
Handschoorset .....	197	LINE MASTER machinegeleiding .....	216
Handtacker .....	315	LINE MASTER mesgeleiding.....	217
Handy bitbox DIAMANT .....	80	LINE MASTER precisieliniaal .....	215
Handy bitbox ISO-TEMP.....	85	LINE MASTER professionele set .....	218
Handy bitbox, RVS.....	86	LINE MASTER universele set.....	218
Handy bitbox STANDAARD .....	89	<b>M</b>	
Handy bitbox, TITAAN genitreerd .....	82, 83	Markeerpunten .....	333
Hardhoutboren.....	60	Maxi-pomp P63.....	119
Hardhoutboren FCE.....	60	Messen- en scharenslijper.....	117
Hardmetalen cirkelsnijder .....	56	Mini-boormachinetoebereenset.....	109
HB 44 SDS-plus-hamerboren .....	35, 36, 37, 38	Mini-pomp P61.....	119
Hechtsteunschijf QUICK-STICK.....	163, 167, 174	Mortelmenger .....	120
Hetelijmpistolen .....	326	Multitool-toebehoren .....	241
HM-rasp.....	241	Multitool-toebehoren .....	239, 240, 241, 242, 243
HM-zaagblad.....	240	Muurdoorvoerboren PROFESSIONEEL.....	47, 48
Holle beitel .....	33	<b>N</b>	
Holle boorkroon .....	128	Nieten voor nietmachines/tackers .....	316, 317, 318
Holle raspfrezen.....	105	Nylon draad .....	309
Holprofielfrezen.....	206, 207	<b>O</b>	
Houderplaat.....	242	Omkeerbare messen: Hardmetalen omkeerbare messen .....	211
Houtboren .....	62, 63, 64	Opnameschacht.....	128, 130
Houten deuvels.....	334	Opnameschacht SDS-PLUS voor boorhouders .....	104
houten deuvels, voorgelijmd.....	334	Opnameschacht voor gatenzagen .....	136
Houten verbindingsschijven.....	335	Opspandoorn .....	201
Houtfrezen.....	108	Opsteekverzinkborensset .....	111
Houtspiraalboren.....	61, 62, 64	<b>P</b>	
Houtspiraalborensset .....	63	Penseelborstels .....	147
Houtspiraalborenssets.....	61	Pensleutel AGGRESSO-FLEX® .....	350
Houtstructuurborstels .....	147	Plaatboren HSS.....	112
Houtverbindingsschijven, voorgelijmd.....	334	Platte beitel .....	33, 39
HSS-invalzaagblad .....	240	Polijspastaset .....	201
HSS-plaatboren .....	112	Polijssets.....	201
HSS-spiraalboren.....	22, 23, 24, 25, 26, 27	Polijspons QUICK-STICK.....	199
HSS-spiraalboren, lange uitvoering.....	23	Polijsvacht .....	200
HSS-spiraalboren, met afgedraaide schacht.....	27	Polijsvacht QUICK-STICK .....	200
HSS-spiraalboren met zeskanthouder 1/4", E 6.3 .....	22	Pompen .....	118, 119
HSS-trappenboren .....	112	Professioneel handschourblok .....	196
<b>I</b>		PROFESSIONELE hamertacker .....	314
Industriële handtacker .....	315	Professionele handtacker .....	315
Installatieboren .....	64, 65	PROFESSIONELE muurdoorvoerboren.....	47, 48
Invalzaagblad.....	239	PROFESSIONELE Power bitbox STANDAARD .....	89
Invalzaagblad CV.....	239	Professionele raspfen.....	105, 106
Invalzaagblad HSS.....	240	PROFESSIONELE scharniergatboormal .....	332
ISO-TEMP bitbox.....	85	PROFESSIONELE speedboren .....	69
ISO-TEMP bits .....	84	Profielfrezen .....	209, 210
<b>K</b>		Profielraspenset.....	107
Kantenfrezen .....	208	Proppenborensset .....	67
Kegelborstels AGGRESSO-FLEX®.....	348	Puntbeitel .....	32, 39
Keramische miniaturslijpstiften.....	117	<b>Q</b>	
Keramische schuurshijven .....	347	QUICK-STICK hechtsteunschijf .....	163, 167, 174
Keramische slijpstiften .....	115, 116	QUICK-STICK kogelgewrichtschijvenset .....	163
KOBALT HSS-CO-spiraalboren .....	10, 11, 12, 13	QUICK-STICK polijstpons.....	199
Komborstels .....	146, 149	QUICK-STICK polijstvacht.....	200
Komborstels AGGRESSO-FLEX® .....	348	QUICK-STICK schuurdriehoeken.....	170, 171, 172, 173, 174
Komborstels, nylon.....	150	QUICK-STICK schuurshijven .....	162, 163, 164, 165, 166
<b>L</b>		QUICK-STICK schuurstroken .....	182, 183, 184
Lakmenger .....	120	QUICK-STICK schuurvlies .....	171, 172
Lamellenslijper.....	198	QUICK-STICK viltfen polijstschijf .....	199
Lappenschijf.....	200	<b>R</b>	
Lijmmenger .....	121	Rasp .....	241
Lijmsticks .....	327	Raspfen.....	105, 106, 107
LINE MASTER .....	215, 216, 217, 218, 219, 220	Reciprozaagbladen.....	233, 234, 235, 236, 237, 238
LINE MASTER bovenfreesgeleiding.....	220	Reciprozaagbladen DIAMANT, tegel- en keramiekbewerking .....	237
LINE MASTER cirkelgeleiding voor decoupeerzagen.....	219	Reciprozaagbladen EASY CUT.....	233, 237
LINE MASTER geleiding voor kwb DÜBELPROFI.....	220	Reinigingsborstels.....	144
LINE MASTER handgreepset .....	217	Reinigingsschijven .....	194, 342
LINE MASTER hoekaanslag.....	215	Reinigingsschijven assortiment, 20-delig .....	194
LINE MASTER klemtang.....	216		

ROCKER® beton- en steenboren .....	42, 43	Staafrezen .....	208
ROCKER® beton- en steenborenssets .....	43, 44	Staalwol .....	195
Rollen schuurmiddel .....	156	STANDAARD bitbox .....	89
Rolsteunbok .....	114	STANDAARD bit- en doppenzet .....	93
RVS bitbox .....	86	STANDAARD bits .....	87, 90, 93
RVS-bits .....	86	STANDAARD bitset .....	93
<b>S</b>		STANDAARD PROFESSIONELE Power bitbox .....	89
Scharniergatboormal .....	332	Steeksleutel AGGRESSO-FLEX® .....	351
Scharniergatboren .....	67	Steenboren .....	46
Schijfborstels .....	144, 145, 146	Steenboren met zeskanthouder 1/4", E 6.3 .....	45
Schijfborstels AGGRESSO-FLEX® .....	349	Steenborensset .....	47
Schijfborstels, messing .....	149	Steen- en betonborensset .....	46
Schijfborstels, nylon .....	150	Steunschijf .....	162
Schijfborstels, rvs .....	149	Steunschijf AGGRESSO-FLEX® .....	344
Schraapstaal .....	241	Steunschijf voor gatenzagen .....	134
Schuurbanden .....	189, 192	Stichsägeblätter .....	230
Schuurdriehoeken .....	174	Stofvanger .....	48
Schuurdriehoeken QUICK-STICK .....	170, 171, 172, 173, 174	SUPER ROCKER® 6-kantbeton- en -steenboren .....	44
Schuurlinnen METAAL & STAAL .....	158	SUPER ROCKER® beton- en -steenborensset .....	45
Schuurmiddel banden .....	189	<b>T</b>	
Schuurmiddelen driehoeken .....	170, 171, 172, 173	Tackernieten .....	316, 317, 318
Schuurmiddelen schijven .....	162, 163, 164, 165, 166	Tackerspijkers .....	318
Schuurmiddel, rollen .....	156	TACKERTRONIX® elektrische tacker .....	314
Schuurmiddel schijven .....	162	Tandkransboorhouder .....	102, 103
Schuurmiddel stroken .....	180, 181, 182, 185	Tegelbeitel .....	40
Schuurmiddel, vellen .....	157, 158, 159	Tegelreparatieset .....	242
Schuurmop CUT-FIX® .....	342	TITAN genitreerde bitboxen .....	82, 83
Schuurmschijven .....	164	TITAN genitreerde bits .....	81
Schuurpads .....	193, 194	TITAN HSS-freesboren .....	112
Schuurpapier .....	157, 158, 159	TITAN HSS-spiraalboren .....	14, 15
Schuurpapier voordeelverpakking .....	157, 158, 159	Trappenboren HSS .....	112
Schuurschijven .....	162	<b>U</b>	
Schuurschijven AGGRESSO-FLEX® .....	347	Universeel invalzaagblad bimetaal .....	239
Schuurschijven CUT-FIX® .....	341	Universele adapter OMT .....	243
Schuurschijven, keramisch .....	347	Universele boren EASY CUT .....	52, 53
Schuurschijven QUICK-STICK .....	162, 163, 164, 165, 166	Universele borstels .....	144
Schuurschijven voordeelverpakking .....	162	Universele hamerboren EASY CUT .....	52
Schuurstroken .....	180, 181, 182, 185	Universele OMT-adapter .....	243
Schuurstroken QUICK-STICK .....	182, 183, 184	Universele set .....	243
Schuurvellen .....	157, 158, 159	<b>V</b>	
Schuurvlies QUICK-STICK .....	171, 172	Verfmenger .....	120
SDS-max-beitel .....	32, 33, 34	Verloopringen voor cirkelzaagbladen .....	277
SDS-max-hamerboor .....	32	Verzinkboren .....	110, 111
SDS-plus-beitel voor boorhamer .....	39, 40	Verzinkborensset .....	110
SILVER STAR HSS-spiraalboren .....	16, 17, 20, 21	Viltten polijstschijf .....	199
Slangschroefboren .....	66	Viltten polijstschijf QUICK-STICK .....	199
Sleufzagen .....	109	Vlakfrezen .....	209
Sleutel voor tandkransboorhouders .....	104	Vliesmopstift .....	198
Slijper voor boren .....	27	Vloer- en inbouwset .....	242
Slijpschijfafritser .....	347	Voordeelverpakking schuurpapier .....	157, 158, 159
Slijpstiften .....	115, 116, 117	Voordeelverpakking Schuurschijven .....	162
Snelspanboorhouder .....	102, 103	Voorgelijmde houten deuvels .....	334
Snelwisselbithouder .....	77	Voorgelijmde houtverbindingsplaatjes .....	334
Spadebeitel .....	33, 39	Vormfrezen .....	107, 108
Spanmoer AGGRESSO-FLEX® .....	350	<b>W</b>	
Sparpack Schleifpapier .....		Waaierborstels, nylon .....	150
speedboorverlengstuk .....	70	Watersysteem .....	132, 133
speedboren PROFESSIONEEL .....	69	Wetsteen .....	117
speedborensset .....	70	Wolfraamstalen gatenzaag .....	136
Spijkers voor tackers .....	318	<b>Z</b>	
Spiraalboren HSS .....	22, 23, 24, 25, 26, 27	Zaagblad diamant .....	240
Spiraalboren KOBALT HSS-CO .....	10, 11, 12, 13	Zaagblad HM .....	240
Spiraalboren SILVER STAR HSS .....	16, 17, 20, 21	Zaagkettingen voor kettingzagen .....	281
Spiraalborenslijper .....	27	zwaluwstaartfrezen .....	207
Spiraalboren TITAN HSS .....	14, 15		
spiraalpijpenborstels .....	148		
Sponningfrezen .....	207		

## kwb-kwaliteitsniveaus

### kwb staat voor kwaliteit.

Met het kwaliteitssysteem van kwb, dat uit drie niveaus bestaat, vindt u altijd het juiste gereedschap voor uw toepassings en gebruiksfrequentie.



#### PROFESSIONAL



De beste kwb-kwaliteit, ook geschikt voor continu gebruik in professionele toepassingen. 5 jaar garantie.



#### HIGH QUALITY



De hoogwaardige kwb-kwaliteit, geschikt voor alle professionals en doe-het-zelvers.



#### QUALITY



De goede gebruikskwaliteit van kwb, voor de doe-het-zelvers.

Open deze pagina  
voor de verklaring van de  
kwb-symbolen en -logo's.

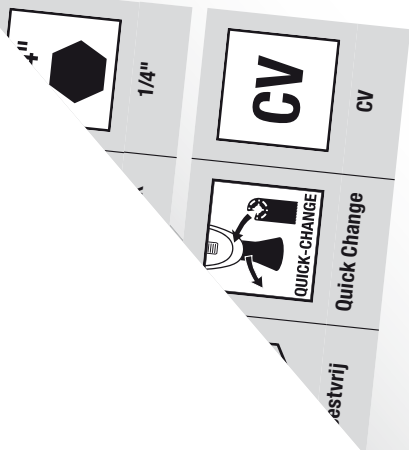

# Overzicht van de kwb-pictogrammen en -logo's

								
Titaan	Rvs	Staal	IJzer	Gietijzer	Non-ferrometaal	Plaatstaal	Profielen	Aluminium
								
Brons	Kunststof	Acryl	Beton	Beton zonder wapening	Steen/metselwerk	Kalkzandsteen	Cellenbeton	Holle bouwsteen
								
Ondervloer	Pleister	Gipsplaat	Lichte bouwmaterialen	Hardhout	Zacht hout	Zacht hout dik	Hardhout	Profielhout
								
Laminaat	Terrasplanken	Bekisting	Multiplex	Spaanplaten (met coating)	Spaanplaten	Bouwhout	Meubelplaat	Glas/kristal
								
Porselein	Keramik/muurtegels	Vloertegels	Gres	Marmar	Klinkers	Betonsteen	Uitgewassen beton	Graniet
								
Dakpannen	Natuursteen	Voegmassa	Tapijtresten	Tegellijm	Verf			
								
Made in EU	Made in Germany	Cross Tip	Diamant	niet stotend	SDS max	SDS plus	SDS quick	1/4"
								
Schacht E 6.3	Impaktor	Stronger	Zeskant	Punt 118°	Punt 135°	Roestvrij	Quick Change	CV
								
HM	OSA	TQ 60	Snelspanboorhouder	Tandkransboorhouder				



**kwb tools GmbH**

Industriestraße 35

D - 28816 Stuhr

Tel.: + 49 (0) 421 8994-0

Fax: + 49 (0) 421 8994-103

welcome@kwb.eu

www.kwb.eu